

Modeling Report for a BART Assessment of the Big Stone I Coal-Fired Power Plant, Big Stone City, South Dakota

October 2009

Prepared For:

**Big Stone I
Otter Tail Power Company,
Big Stone City, South Dakota**

Prepared By:

**TRC Environmental Corporation
650 Suffolk Street
Lowell, Massachusetts 01854
(978) 970-5600**

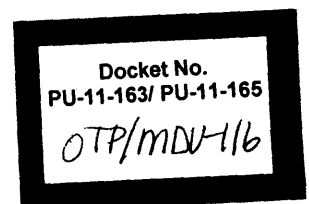

TABLE OF CONTENTS

	Page
1. INTRODUCTION.....	1-1
2. SOURCE DESCRIPTION	2-1
3. GEOPHYSICAL AND METEOROLOGICAL DATA.....	3-1
3.1 Terrain	3-1
3.2 Land Use.....	3-1
3.3 Meteorological Data Base	3-2
3.4 Air Quality Monitoring Data	3-10
4. AIR QUALITY MODELING OPTIONS	4-1
4.1 Modeling Domain.....	4-1
4.2 Meteorological Modeling Options.....	4-1
4.2 Dispersion Modeling Options.....	4-2
4.3 Visibility Calculations	4-3
5. RESULTS	5-1
6. REFERENCES.....	6-1
APPENDIX A –CALPOST VISIBILITY METHOD 8	A-1
APPENDIX B – MM5 CONFIGURATION	B-1
APPENDIX C – CALMET CONTROL FILE	C-1

LIST OF FIGURES

	Page
Figure 3-1. Terrain elevations for the CALMET and CALPUFF modeling domain at 4 km resolution. The locations of the Big Stone facility and Class I areas are also shown.	3-3
Figure 3-2. Dominant land use categories at 4 km resolution on the CALMET and CALPUFF modeling domains. The locations of the Big Stone facility and Class I areas are also shown.	3-4
Figure 3-3. Plot of upper air stations available in the modeling domain.	3-8
Figure 3-4. Plot of surface and precipitation stations available in the modeling domain.	3-9
Figure B-1. Map showing the MM5 Domain 1 (36-km) and Domain 2 (12-km).	B-4

LIST OF TABLES

	Page
Table 2-1: Point Source Parameters and Emission Rates	2-2
Table 2-2: PM ₁₀ Size Distribution I	2-2
Table 2-3: PM ₁₀ Speciation and Size Distribution	2-3
Table 3-1: U.S. Geological Survey Land Use and Land Cover Classification System	3-5
Table 3-2: Default CALMET Land Use Categories and Associated Geophysical Parameters based on the U.S. Geological Survey Land Use Classification System (14-Category System)	3-6
Table 3-3: Meteorological Data Sources and Parameters Available	3-7
Table 4-1: Rayleigh Scattering Term (Mm ⁻¹) for each Class I area as a Function of Elevation	4-6
Table 4-2: Annual Averaged Conditions Levels of Aerosol Components (µg/m ³) to Define Natural Background (FLAG 2008) – Method 8 values per Class I Area	4-6
Table 4-3: Monthly Site-Specific RH adjustment factors f(RH) values for hygroscopic species – Small ammonium sulfate and ammonium nitrate particles - Method 8 (FLAG, 2008)	4-7
Table 4-4: Monthly Site-Specific RH adjustment factors f(RH) values for hygroscopic species – Large ammonium sulfate and ammonium nitrate particles – Method 8 (FLAG, 2008)	4-7
Table 4-5: Monthly Site-Specific RH adjustment factors f(RH) values for hygroscopic species – Sea salt particles - Method 8 (FLAG, 2008)	4-7
Table 5-1: Visibility impacts for 2002. Constant (1 ppb) ammonia.	5-2
Table 5-2: Visibility impacts for 2006. Constant (1 ppb) ammonia.	5-2
Table 5-3: Visibility impacts for 2007. Constant (1 ppb) ammonia.	5-2
Table 5-4: Visibility impacts with ALM considered for 2002.	5-3
Table 5-5: Visibility impacts with ALM considered for 2006.	5-3
Table 5-6: Visibility impacts with ALM considered for 2007.	5-3
Table B-1: Domain Configuration and Parameterizations for 2006 and 2007 MM5 Simulations. The Lambert Conical Conformal (LCC) map projection is used in the MM5 modeling.	B-3
Table B-2: Sigma Levels used in the North American MM5 Simulations for 2006 and 2007.	B-5
Table B-3: Performance Statistics by Year – MM5 Simulations – 12-km Grid Resolution	B-8

1. INTRODUCTION

TRC Environmental Corporation has conducted a site-specific BART (Best Available Retrofit Technology) modeling assessment of the Big Stone I coal-fired power plant facility located near Milbank and Big Stone City in South Dakota to determine if this facility is subject to BART controls on emissions. This report is a modeling assessment of baseline impacts from the Big Stone I power plant facility to determine whether the Big Stone I cyclone-fired boiler is subject to BART.

On July 6, 2005 the U.S. Environmental Protection Agency (U.S. EPA) published in the Federal Register the "Regional Haze Regulations and Guidelines for Best Available Retrofit Technology (BART) Determinations" (40 CFR Part 51). The regional haze rule requires States to submit implementation plans (SIPs) to address regional haze visibility impairment in 156 Federally-protected parks and wilderness areas, commonly referred to as "Class 1 Areas". The final rule addresses BART-eligible sources, which are defined as sources that have the potential to emit 250 tons or more of a visibility-impairing air pollutant, were put in place between August 7, 1962 and August 7, 1977 and whose operations fall within one or more of 26 specifically listed source categories, of which Coal-Fired Power Plants are one.

In January 2009, a modeling protocol was submitted by TRC for the Big Stone I BART modeling based on the use of fine scale meteorological modeling, MM5 data and hourly surface meteorological observations. In response to comments received from Environmental Protection Agency (EPA) and the Federal Land Managers (FLMs), a revised protocol was submitted in June 2009, proposing the use of higher resolution MM5 data with the EPA-recommended modeling input parameters. Based on further discussions with EPA, the FLMs and South Dakota Department of Environment and Natural Resources (DENR), subsequent revisions were made to the June protocol on August 31, 2009. DENR approved the revised protocol in a letter dated September 18, 2009. The modeling described in this report is consistent with the DENR's approved protocol (except as noted below) and is based on the emissions data described in the June 2009 TRC protocol along with the August 2009 revisions to incorporate EPA-recommended model switch settings and meteorological configuration. The exceptions to the protocol include the use of MNITRATE=0 instead of MNITRATE=1 in POSTUTIL for the baseline runs and the use of MNITRATE=3 for a set of alternative runs. See Section 3.4 for a more detail discussion. Also, the variable IUTMZN referred to in the EPA-recommended list of variables was not assigned because that variable is not used when using a Lambert Conformal projection.

The purpose of the modeling is to assess the visibility impacts of sulfur dioxide (SO₂), particulate matter (PM) and nitrogen oxides (NO_x) emissions from the Big Stone I boiler and compare the impacts to the 0.5 change in deciview threshold at all the federally mandatory Class I areas. Since there is no Class I area within the 300 km radius usually applied, the South Dakota Department of Environment and Natural Resources requested that the Class I areas between 300 km and up to 625 km away from the Big Stone I facility sources be modeled. A total of eight Class I areas are located between these distances: two wilderness areas: Boundary Waters Canoe Area Wilderness

and Rainbow Lake Wilderness, one National Wildlife Refuge (NWR): Lostwood and five National Parks: Voyageurs NP, Theodore Roosevelt NP, Badlands NP, Wind Cave NP and Isle Royale NP. However, Rainbow Lake Wilderness is one of two Class I areas where the visibility analysis is not required (<http://www.dnr.state.wi.us/org/aw/air/modeling/psd.htm>), so it is not included in the modeling analysis. The MM5 datasets distributed by WRAP did not extend far enough in the East to include the Isle Royale NP or cover all of the Boundary Waters Class I area. The re-extracted MM5 data for 2002 and new MM5 domains for 2006 and 2007 include these areas.

The CALMET and CALPUFF non-steady-state models (Scire et al., 2000a,b) are recommended by the U.S. EPA (*Federal Register*, 6 July 2005) to perform source-specific subject-to-BART screening. The CALPUFF system was therefore used for this modeling analysis. The U.S. EPA has promulgated the CALPUFF modeling system as a *Guideline Model* for Class I impact assessments and other long range transport applications or near field applications involving complex flows (U.S. EPA, 2000), and the model is recommended by both the Federal Land Managers (FLM) Air Quality Workgroup (FLAG, 2000) and the Interagency Workgroup on Air Quality Modeling (IWAQM, 1998). The CALPUFF modeling system is also recommended in new proposed guidance by the FLMs (FLAG, 2008). On August 31, 2009 EPA issued new recommendations on CALMET switch settings. The current modeling is based on the August 2009 recommendations.

The Big Stone I BART modeling analysis was performed with the EPA-approved Version 5.8 of the CALMET and CALPUFF models. Version 6.221 of CALPOST was used because it contains the FLM-approved implementation of Method 8 (FLAG, 2008), but in other respects is identical to the EPA-approved Version 5.6394.

CALMET is a diagnostic meteorological model that produces three-dimensional wind fields based on parameterized treatments of terrain effects such as slope flows and terrain blocking effects. Normally, meteorological observations are blended with gridded data from the NCAR-PSU Mesoscale Model, Version 5 (MM5). For this evaluation, MM5 data were generated by TRC with a 12-km grid spacing for two years (2006 and 2007) to define the initial guess wind fields. For 2002, 12-km MM5 data were re-extracted from the EPA MM5 dataset to cover entire region including the Isle Royale NP to the east.

CALPUFF is a non-steady-state puff dispersion model. It accounts for spatial changes in the CALMET-produced meteorological fields, variability in surface conditions (elevation, surface roughness, vegetation type, etc.), chemical transformation, wet removal due to rain and snow, dry deposition, and terrain influences on plume interaction with the surface. CALPUFF contains a module to compute visibility effects, based on a humidity-dependent relationship between particulate matter concentrations and light extinction, as well as wet and dry acid deposition fluxes. The meteorological and dispersion modeling simulations were conducted for three years (2002, 2006 and 2007). SO₂, SO₄, PM, and NO_x emissions and their secondary products resulting from chemical conversions from the Big Stone I facility were modeled and their impacts on visibility evaluated at receptors in the Class I areas. Visibility impacts were estimated with the new

FLM-recommended visibility algorithm and monthly average relative humidity adjustment factors (Method 8 in Version 6.221).

This report outlines the techniques and data sources used in the BART analyses. In Section 2, a general description of the source configuration is provided. Descriptions of the site characteristics and data bases (meteorological, geophysical, and aerometric) are provided in Section 3. Section 4 includes an overview of the CALMET and CALPUFF models settings and parameters that were used in the analysis. The results are summarized in Section 5.

2. SOURCE DESCRIPTION

The 450-megawatt Big Stone I facility is a coal-fired power plant situated close to Big Stone City and Milbank in Grant County, South Dakota, at the border of Minnesota State. A BART applicability analysis was completed for the facility to determine those sources subject to the BART controls. The BART-eligible source is the Big Stone I cyclone-fired boiler with one stack 152 meters (498 feet) high.

The proposed emissions for the BART analysis were described in a Modeling Protocol dated June 2009. These emissions were reviewed and approved by SD DENR. Table 2-1 shows the source parameters and emission rates for the source considered in this report. The highest 24-hour average actual emission rates of SO₂, NO_x and PM under normal conditions over the 2001-2003 period were used for this analysis. As shown in Table 2-2, the filterable PM₁₀ are divided into a particle size distribution based on AP-42, Table 1.1-6 for baghouse controlled emissions because the facility currently uses a fabric filter for PM control. Approximately 57.6% of the filterable mass is in the fine (PM_{2.5}) size category, and 42.4% in the coarse (2.5 to 10 μm diameter) size range. Each of the particle size categories was modeled as a separate PM species in CALPUFF. The filterable PM₁₀ emission rate is reported by the facility at 10.48 g/s (83.2 lb/hr). Based on AP-42 Table 1.1-5, the total condensable PM₁₀ is approximately 0.01 lb/mmBtu based on approximately 0.4% sulfur coal or 7.07 g/sec (56.1 lb/hr) assuming an heat input of 5609 mmBtu/hr. This estimate is consistent with the stack test data (August, 2006) at Otter Tail Power's Hoot Lake Plant, Unit 2, (which burns PRB coal) where the ratio of the filterable/total PM₁₀ was 0.66, resulting in a 2/3 filterable and 1/3 condensable split to the total PM₁₀.¹

Elemental Carbon (EC) emissions were assumed to be 3.7% of the fine filterable fraction based on U.S. EPA (2002) and were assigned to the smallest particle size category. The primary H₂SO₄ emissions are 0.454 g/s (3.604 lb/hr) based on annual emission inventories and Toxic Release Inventory reports. The remaining condensable emissions were assigned to organic carbon and distributed equally into the two smallest particle size categories.

Table 2-3 provides a summary of the PM₁₀ speciation and size distribution.

Note that since all Class I areas are more than 50 km away from the facility, as recommended by the Federal Land Managers (FLMs) (US Fish and Wildlife, National Park Service and U.S. Forest Service), no downwash computations was performed.

¹ AP-42 Table 1.1-8 was not used to estimate the particulate matter size distribution for Big Stone I because the emission factors were derived for cyclones burning bituminous coal, not sub-bituminous coal which is burned at Big Stone I.

Table 2-1: Point Source Parameters and Emission Rates

Source	LCC ¹ East (km)	LCC ¹ North (km)	Stack Ht (m)	Base Elevation (m)	Stack Diameter (m)	Exit Velocity (m/s)	Exit Temp. (K)	SO ₂ Emission Rate (g/s)	H ₂ SO ₄ Emission Rate (g/s)	NO _x Emission Rate (g/s)	Filterable PM ₁₀ Emission Rate (g/s)	Condensable PM ₁₀ Emission Rate (g/s)
Main Stack	38.141	587.875	151.79	328.90	7.37	20.14	423.00	608.9	0.454	611.7	10.48	7.07

¹ Lambert Conformal Projection with an origin of 40.0N, 97.0W and standard parallels at 33N and 45N. Datum is NWS-84.

Table 2-2: PM₁₀ Size Distribution¹

Particle Size ² (μm)	Cumulative Mass (PM) (%)	Cumulative Mass (PM ₁₀) (%)
15	97	-
10	92	100
6	77	83.7
2.5	53	57.6
1.25	31	33.7
1.00	25	27.2

¹ From AP-42, Table 1.1-6, Cumulative particle size distribution and size-specific emission factors for dry bottom boilers burning pulverized bituminous and subbituminous coal.

² Expressed as aerodynamic equivalent diameter.

Table 2-3: PM₁₀ Speciation and Size Distribution

input Data:								H ₂ SO ₄	PM ₁₀	PM _{2.5}		
								g/s	g/s	g/s		
PM ₁₀ and H ₂ SO ₄ Emissions (g/s)								0.454	17.550	13.196		
	filterable							condensable				
condensable %	59.7%							40.3%				
	g/s							g/s				
	10.480							7.070				
								non H₂SO₄ condensable				
								g/s				
								6.616				
	AP-42, Table 1.1-6											
	coarse	coarse	soil	soil	soil	soil	EC	H ₂ SO ₄	OC	OC	IC (soil)	IC (soil)
	PM800	PM425	PM187	PM112	PM081	PM056	PM056		PM081	PM056	PM081	PM056
	6.00 - 10.00	2.50-6.00	1.25-2.50	1.00-1.25	0.625-1.00	0.50-0.625	0.50-0.625		0.625-1.00	0.50-0.625	0.625-1.00	0.50-0.625
	16.3%	26.1%	23.9%	6.5%	12.0%	15.2%	57.6%		50.0%	50.0%	50.0%	50.0%
EC % of filterable	96.3%							3.7%	100%		0%	
inorganic % of condensable	g/s	g/s	g/s	g/s	g/s	g/s	g/s	g/s	g/s	g/s		
	1.708	2.735	2.412	0.656	1.211	1.534	0.223	0.454	3.308	3.308		
	inputs to POSTUTIL:											
Extinction coefficient	0.6	0.6	1	1	1	1	10	3*f(RH)	4	4		
	coarse	coarse	soil	soil	soil	soil	EC	H ₂ SO ₄	OC	OC		
	PM800	PM425	PM187	PM112	PM081	PM056	PM056		PM081	PM056		
	g/s	g/s	g/s	g/s	g/s	g/s	g/s	g/s	g/s	g/s		
	1.708	2.735	2.412	0.656	1.211	1.534	0.223	0.454	3.308	3.308		

3. GEOPHYSICAL AND METEOROLOGICAL DATA

The South Dakota Department of Environment and Natural Resources requested that the eight Class I areas shown in Figure 3-1 be considered in the BART analysis. Rainbow Lake Wilderness is one of two Class I areas where the visibility analysis is not required so it has been removed from the present analysis (see <http://www.dnr.state.wi.us/org/aw/air/modeling/psd.htm>). The MM5 dataset for this analysis were extended to include the Isle Royale National Park as well as all of the Boundary Waters Class I area.

3.1 Terrain

The topography of the domain area consists of terrain increasing toward the southwest from approximately 300 meters at the facility to 900 meters at Badlands NP and 1200 meters at Wind Cave NP, resulting in 900 meters (~3,000 feet) of terrain relief. The terrain relief also increases towards the northeast. The terrain gets mountainous on the west side of the facility near Badlands and Wind Cave National Parks.

Gridded terrain elevations for the refined modeling domain were derived from 3 arc-second digital elevation models (DEMs) produced by the United States Geological Survey (USGS). Data are provided in files covering 1 degree by 1 degree blocks of latitude and longitude. The 1-degree DEMs are produced by the Defense Mapping Agency using cartographic and photographic sources. USGS 1:250,000 scale topographic maps are the primary source of 1-degree DEMs.

One degree DEM data consists of an array of 1201 by 1201 elevations referenced on the geographic (latitude/longitude) coordinate system of the World Geodetic System 1972 Datum. Elevations are in meters relative to mean sea level, and the spacing of the elevations along each profile is 3 arc-seconds, which corresponds to a spacing of approximately 90 meters. For the North part of the east domain and north west domain covering the south side of Manitoba and Ontario, Canada, SRTM-3 data with also an approximate resolution of 90 meters were used.

The MM5 simulations conducted at 12-km grid spacing covering the modeling domain were used as initial guess field. CALMET was run at the 4-km resolution.

The USGS elevation records located within each grid cell in the computational domain are averaged to produce a mean elevation at each grid point. The CALPUFF computational domain is the same as the CALMET domain. The CALMET and CALPUFF domains extend at least 50 km beyond the Class I areas in order to provide an adequate buffer zone at the boundaries, and to allow the effects of flow curvature and possible small-scale recirculation to be evaluated.

3.2 Land Use

The Composite Theme Grid (CTG) land use data from the USGS, at a resolution of approximately 90m were processed to produce gridded fields of dominant land use categories for each grid cell. For the northern part of the domain covering Canada (south part of Manitoba and Ontario), 900 meters Global USGS land use data were also incorporated using a mesh density for sampling of 2.

Land use data are first processed to produce fractional land use categories. The 37 USGS land use categories are then mapped into 14 CALMET land use categories. Surface properties such as albedo, Bowen ratio, roughness length, and leaf area index are computed proportionally to the fractional land use. The USGS land use categories are described in Table 3-1. Table 3-2 displays the 14 CALMET land use categories and their associated geophysical parameters. Figure 3-2 shows the dominant land use categories used in the modeling.

3.3 Meteorological Data Base

The CALMET model has the ability to assimilate meteorological information from surface stations, precipitation stations, buoy data and upper air stations. Specifically, CALMET uses surface observations of wind speed, wind direction, temperature, cloud cover, ceiling height, surface pressure, relative humidity, and precipitation type (e.g., snow, rain, etc.). These variables are routinely measured at the National Weather Service (NWS) surface stations and were directly included on an hourly basis into CALMET. Upper air observations however are only available twice-daily at a few stations throughout the domain. The locations of the upper air stations in and around the region of interest, and used in the modeling, are displayed in Figure 3-3.

The surface, buoy and precipitation stations that were included in the modeling are displayed in Figure 3-4. For 2002, there are 272 surface stations, 2 buoys and 265 precipitation stations available with similar numbers in 2006 and 2007. Observed cloud cover and ceiling height from the surface meteorological stations were used in the analysis.

The three-dimensional gridded data from the prognostic numerical model MM5 with nested grids of 36-km, 12-km grid spacing were generated by TRC for 2006 and 2007. Information about the MM5 model configuration and an evaluation of model performance are provided in Appendix B.

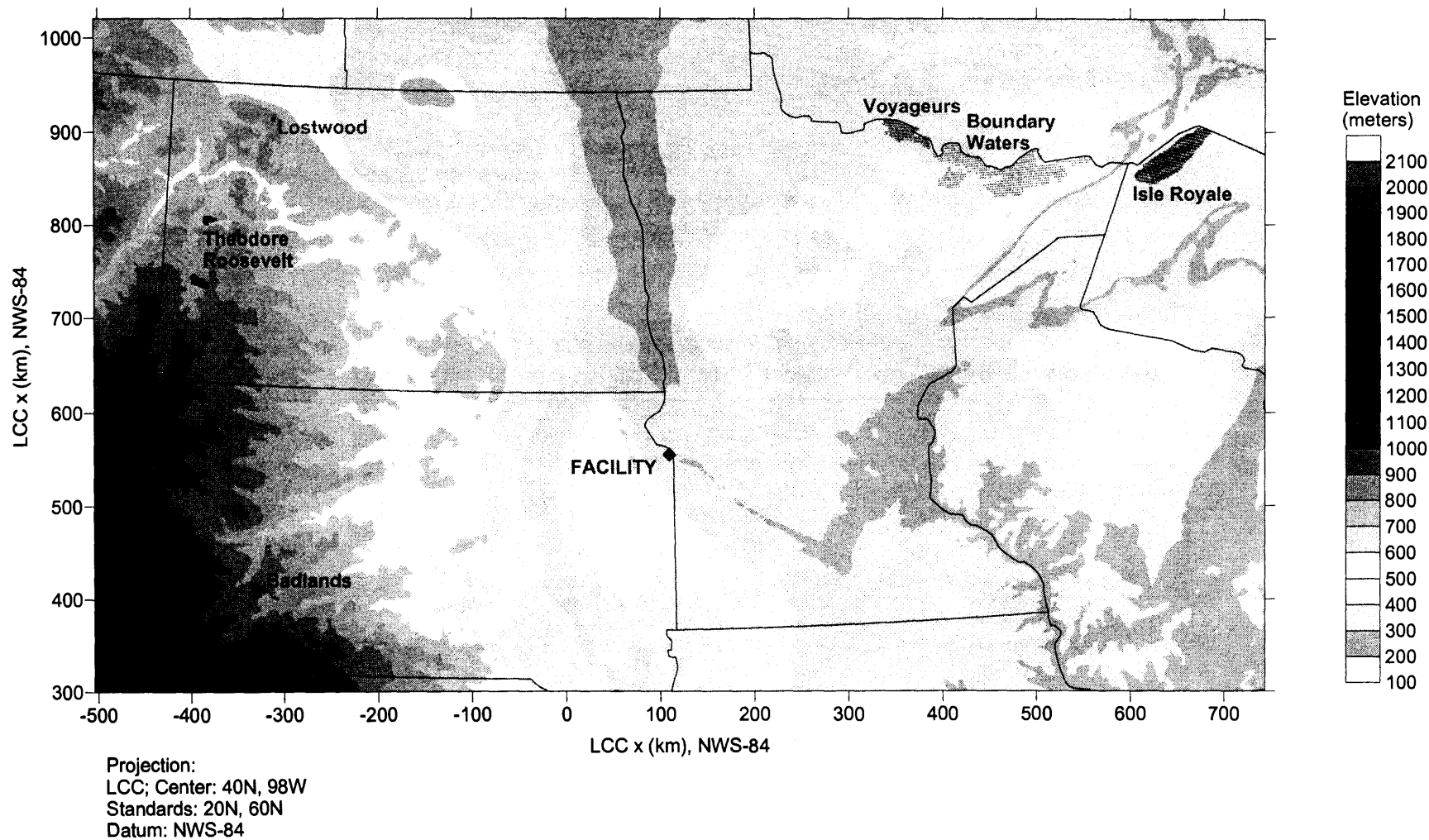

Figure 3-1. Terrain elevations for the CALMET and CALPUFF modeling domain at 4 km resolution. The locations of the Big Stone facility and Class I areas are also shown.

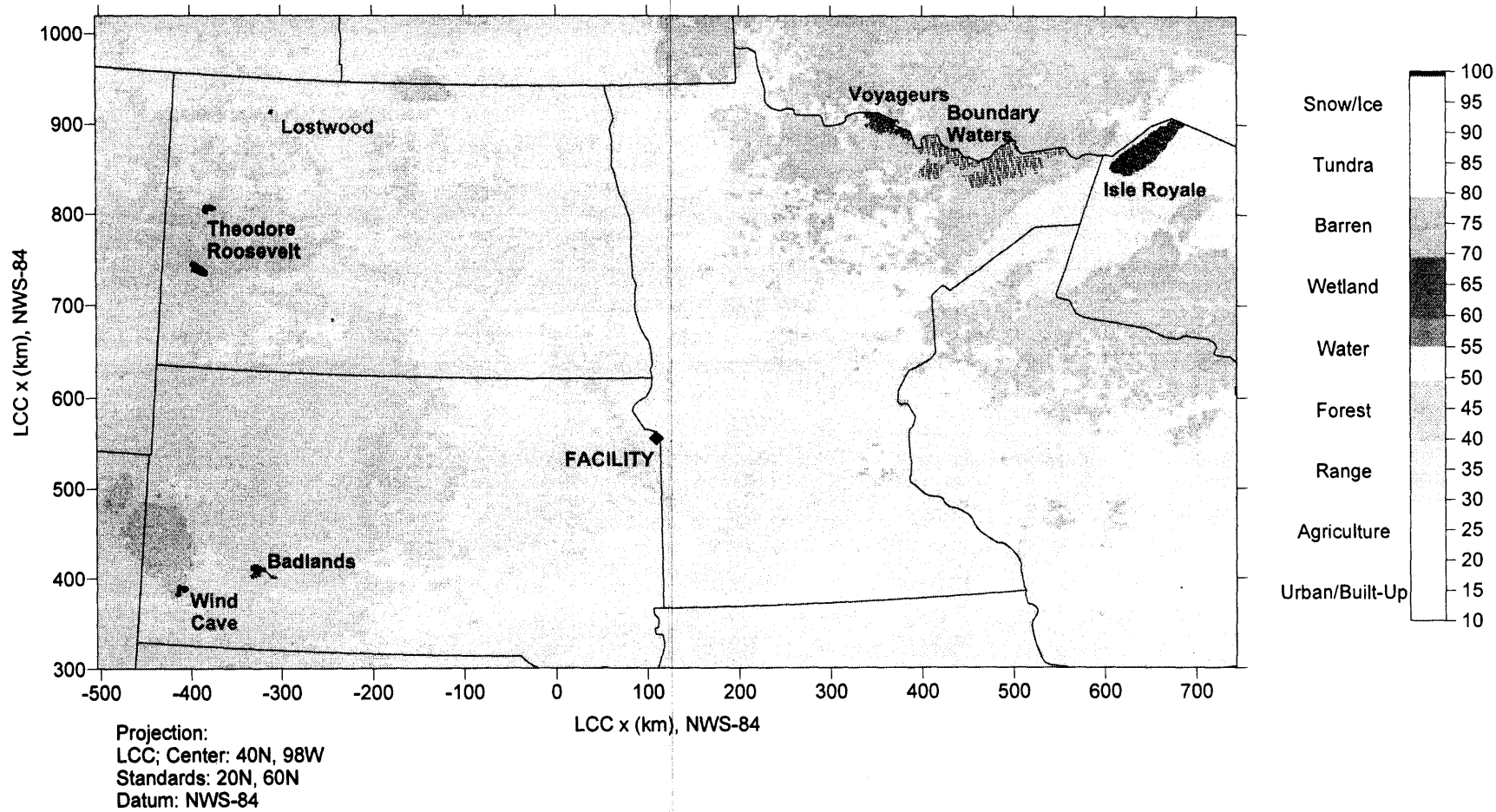

Figure 3-2. Dominant land use categories at 4 km resolution on the CALMET and CALPUFF modeling domains. The locations of the Big Stone facility and Class I areas are also shown.

Table 3-1: U.S. Geological Survey Land Use and Land Cover Classification System

	Level I		Level II
10	Urban or Built-up Land	11 12 13 14 15 16 17	Residential Commercial and Services Industrial Transportation, Communications and Utilities Industrial and Commercial Complexes Mixed Urban or Built-up Land Other Urban or Built-up Land
20	Agricultural Land	21 22 23 24	Cropland and Pasture Orchards, Groves, Vineyards, Nurseries, and Ornamental Horticultural Areas Confined Feeding Operations Other Agricultural Land
30	Rangeland	31 32 33	Herbaceous Rangeland Shrub and Brush Rangeland Mixed Rangeland
40	Forest Land	41 42 43	Deciduous Forest Land Evergreen Forest Land Mixed Forest Land
50	Water	51 52 53 54 55	Streams and Canals Lakes Reservoirs Bays and Estuaries Oceans and Seas
60	Wetland	61 62	Forested Wetland Non-Forested Wetland
70	Barren Land	71 72 73 74 75 76 77	Dry Salt Flats Beaches Sandy Areas Other than Beaches Bare Exposed Rock Strip Mines, Quarries, and Gravel Pits Transitional Areas Mixed Barren Land
80	Tundra	81 82 83 84 85	Shrub and Brush Tundra Herbaceous Tundra Bare Ground Wet Tundra Mixed Tundra
90	Perennial Snow or Ice	91 92	Perennial Snowfields Glaciers

Table 3-2. Default CALMET Land Use Categories and Associated Geophysical Parameters based on the U.S. Geological Survey Land Use Classification System (14-Category System)

<u>Land Use Type</u>	<u>Description</u>	<u>Surface Roughness (m)</u>	<u>Albedo</u>	<u>Bowen Ratio</u>	<u>Soil Heat Flux Parameter</u>	<u>Anthropogenic Heat Flux (W/m²)</u>	<u>Leaf Area Index</u>
10	Urban or Built-up Land	1.0	0.18	1.5	.25	0.0	0.2
20	Agricultural Land - Unirrigated	0.25	0.15	1.0	.15	0.0	3.0
-20*	Agricultural Land - Irrigated	0.25	0.15	0.5	.15	0.0	3.0
30	Rangeland	0.05	0.25	1.0	.15	0.0	0.5
40	Forest Land	1.0	0.10	1.0	.15	0.0	7.0
50	Water	0.001	0.10	0.0	1.0	0.0	0.0
54	Small Water Body	0.001	0.10	0.0	1.0	0.0	0.0
55	Large Water Body	0.001	0.10	0.0	1.0	0.0	0.0
60	Wetland	1.0	0.10	0.5	.25	0.0	2.0
61	Forested Wetland	1.0	0.1	0.5	0.25	0.0	2.0
62	Nonforested Wetland	0.2	0.1	0.1	0.25	0.0	1.0
70	Barren Land	0.05	0.30	1.0	.15	0.0	0.05
80	Tundra	.20	0.30	0.5	.15	0.0	0.0
90	Perennial Snow or Ice	.05	0.70	0.5	.15	0.0	0.0

* Negative values indicate "irrigated" land use

Table 3-3. Meteorological Data Sources and Parameters Available

Type of Dataset	Frequency	Source	Parameters available
Surface Observations	Hourly	NWS	Wind speed, wind direction, temperature, ceiling height, cloud cover, relative humidity, surface pressure, precipitation type
Upper Air	Twice-daily	NWS/NCDC	Soundings of wind speed, wind direction, temperature, and pressure
Precipitation Observations	Hourly	NWS	Precipitation rate
Buoy	Hourly	NWS/NCDC	Air-sea surface temperature difference, air temperature, relative humidity, overwater mixing height, temperature lapse rate below the mixing height overwater, temperature lapse rate above the mixing height overwater, wind speed, wind direction, dominant wave period, significant wave height
Modeled Profiles MM5 for 2002, 2006 and 2007	Hourly	EPA – 2002 TRC - 2006, 2007	Hourly, gridded fields of winds, temperature, pressure, and humidity and liquid water content on 12-km grid.

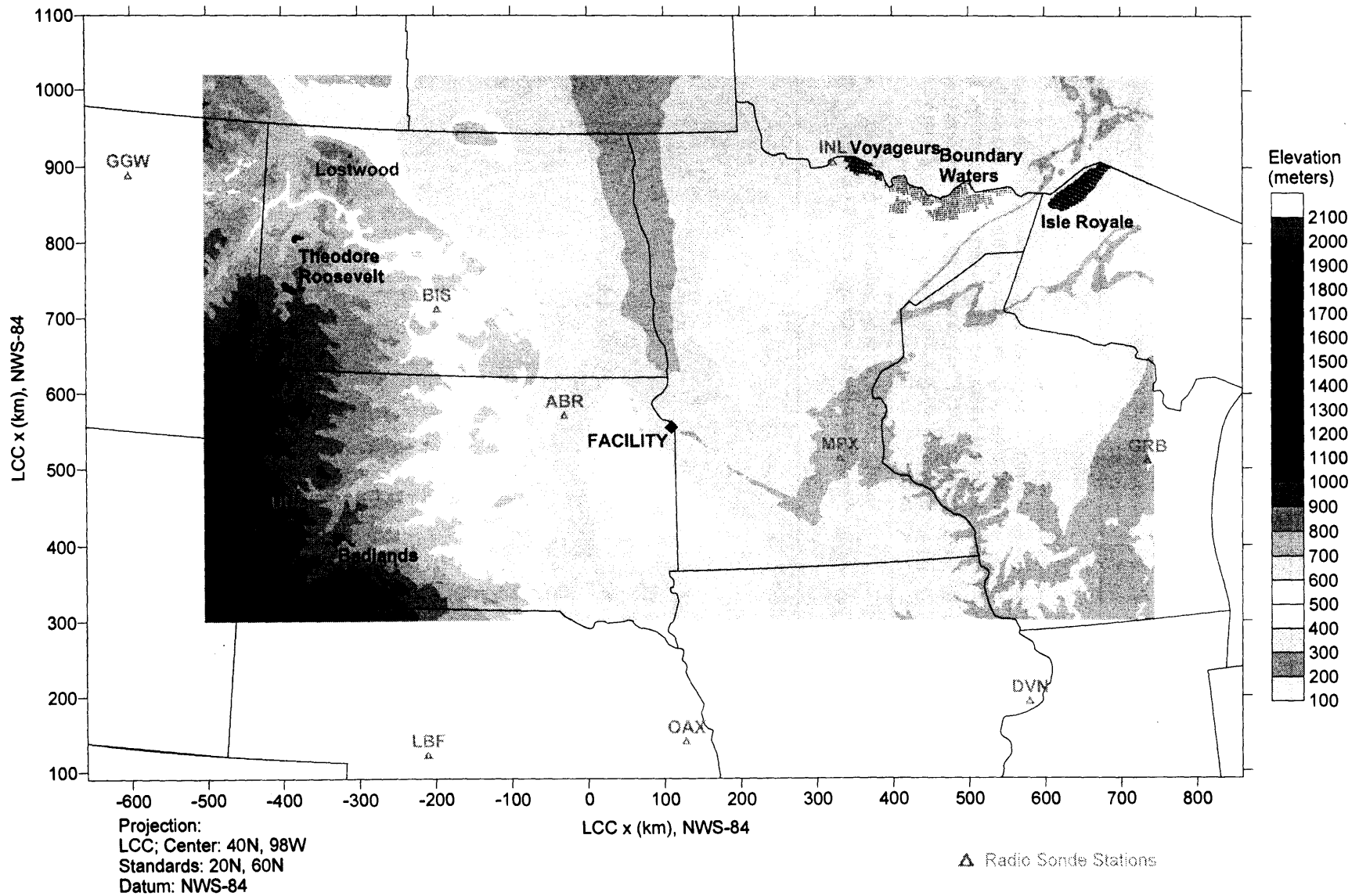

Figure 3-3. Plot of upper air stations available in the modeling domain.

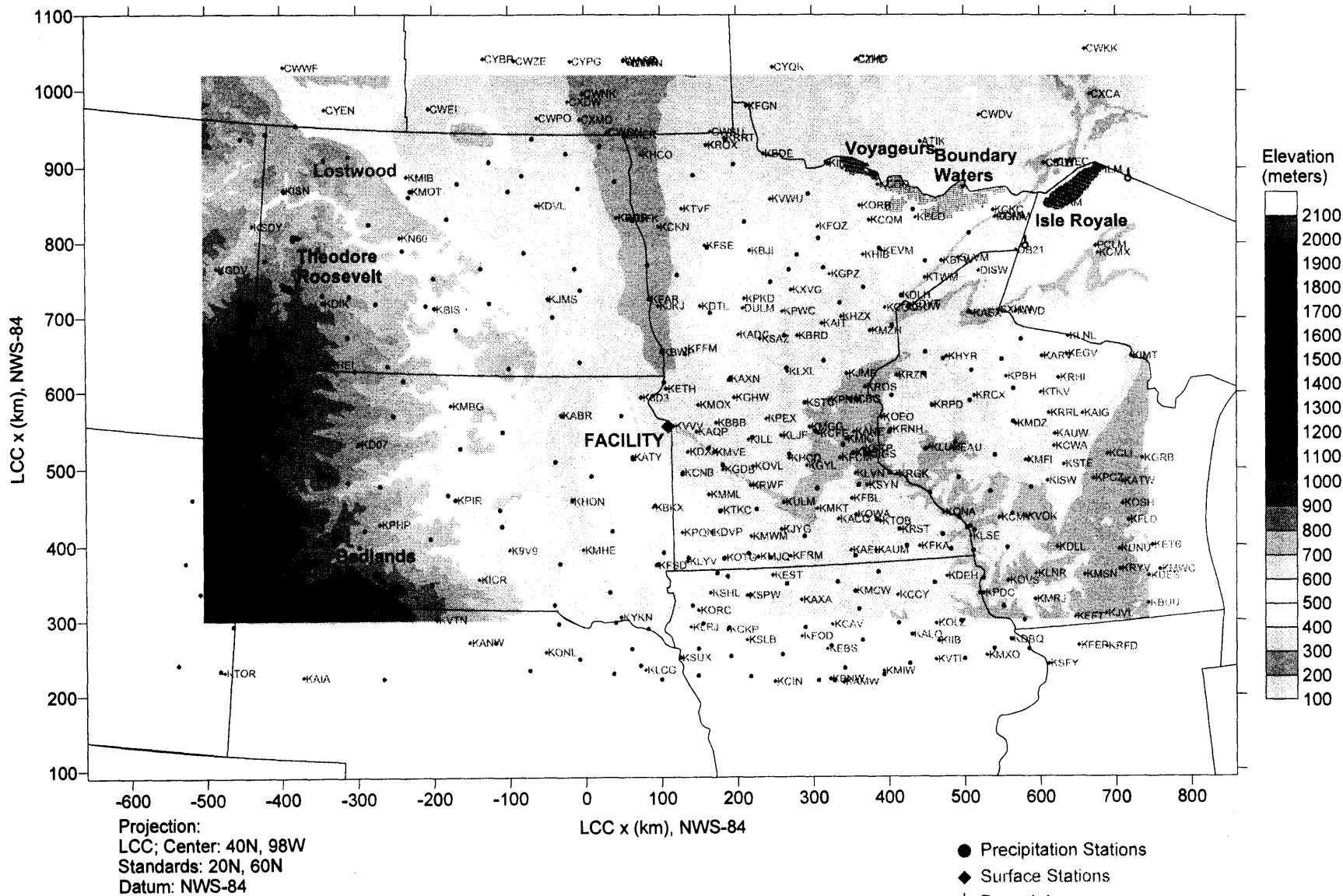

Figure 3-4. Plot of surface and precipitation stations available in the modeling domain.

3.4 Air Quality Monitoring Data

CALPUFF used hourly ozone concentration measurements in the chemical transformation rates (SO_2 to SO_4 , NO_x to HNO_3/NO_3). The ambient ozone measurements are used in determining SO_2 loss rates due to chemical transformation to sulfate and in determining NO_x loss rates to nitrate. Ambient ozone hourly concentrations from EPA AIRS and CASTNet networks for 2002, 2006 and 2007 were processed into OZONE.DAT files and used as ozone background in CALPUFF. An 80 parts per billion (ppb) concentration was used as backup when hourly ozone concentrations are missing, which given the number of ozone stations was unlikely to be used.

A constant background ammonia concentration of 1 parts per billion (ppb) as recommended by the FLMs and EPA was used in the CALPUFF runs. No additional repartitioning was done on the nitrate concentrations in the base simulations (MNITRATE=0). This may produce some double-counting of ammonia in the calculation of nitrate, but any differences are likely to be small.

Additional postprocessing was conducted using POSTUTIL for an alternative case based on the full ammonia limiting method (MNITRATE=3) using background monthly average sulfate, total nitrate and total ammonia data from the 2002 CMAQ model. This option accounts for both overlapping puffs from the modeled source as well as spatial and monthly variability of ammonia and background sulfate and nitrate from sources not included in the CALPUFF simulations. The results from these simulations are also presented in Section 5.

4. AIR QUALITY MODELING OPTIONS

4.1 Modeling Domain

CALMET and CALPUFF use terrain-following coordinates. In order to cover a large enough area for the refined analysis covering all seven Class I areas within a single domain, and including a buffer of at least 50 km around each Class I area, the domain dimensions of 1250 km x 720 km were used. For a 4-km grid spacing, this amounts to 313 x 181 grid cells. In the vertical, a stretched grid was used with finer resolution in the lower layers and somewhat coarser resolution aloft thus allowing adequate representation of the mixed layer. The ten vertical levels were centered at: 10, 30, 60, 120, 240, 480, 920, 1600, 2500 and 3500 meters.

CALMET and CALPUFF were run for three years, 2002, 2006 and 2007. A network of discrete receptors derived from the list of receptors developed by the National Park Service (NPS) are located within the boundaries of the seven Class I areas modeled: Boundary Waters Canoe Area Wilderness, Voyageurs National Park, Badlands National Park, Wind Cave National Park, Lostwood National Wildlife Refuge, Theodore Roosevelt National Park and Isle Royale National Park.

4.2 Meteorological Modeling Options

4-km Simulation. EPA-approved Version 5.8 Level 070623 of CALMET was run using the recommended switch settings from U.S. EPA (2009). This includes using the regulatory set of options, including Maul-Carson convective mixing height over land only (IMIXH= - 1), OCD delta-T method for overwater fluxes (ICOARE=0), and no convective heat flux threshold overland (THRESHL= 0 W/m³). These values of IMIXH, ICOARE and THRESHL, differ from the settings in the CALMET input files provided for sources located in South Dakota state on the WRAP Regional Modeling Center web page <http://pah.cert.ucr.edu/aqm/308/bart.shtml>, but follow regulatory guidance set by EPA. In addition, NOOBS was set to 0 in this application rather than 1 as in the WRAP CALMET inputs.

Initial Guess Field

MM5 data were used to define the initial guess field for the CALMET simulations (IPROG=14). For all three years hourly MM5 data with a grid spacing of 12 km were used in the modeling. The CALMET horizontal grid spacing was set to 4 km.

CALMET runs were conducted using the traditional model options including diagnostic adjustments for terrain effects, with the typical 2:1 ratio of RMAX1/R1 and RMAX2/R2. In these simulations RMAX1=100 km, RMAX2=200 km, R1=50 km and R2=100 km were used. This is consistent with the U.S. EPA (2009) recommendations. NOOBS=0 was used in the 4-km simulations. Precipitation rates were determined based on precipitation station measurements. Cloud amount and ceiling height were derived from the surface station measurements. Overwater air-sea temperature difference were derived from the buoy data (ITWPROG=0). Three-dimensional temperature fields were determined from surface and upper air observations (ITPROG=0).

Step 1 Field: Terrain Effects

In developing the Step 1 wind field, CALMET adjusts the initial guess field to terrain effects, including slope flows and blocking effects. Slope flows are a function of the local slope and altitude of the nearest crest. The crest is defined as the highest peak within a radius TERRAD around each grid point. A value of TERRAD of 15 km was used in the CALMET simulations as it is recommended by the U.S. EPA (2009) and in agreement with an analysis of the scale of the terrain. The Step 1 field produces a flow field consistent with the fine-scale CALMET terrain resolution (4 km).

Step 2 Field: Objective Analysis

In Step 2, observations are incorporated into the Step 1 wind field to produce a final wind field. Each observation site influences the final wind field within a radius of influence (parameters RMAX1 at the surface, RMAX2 aloft and RMAX3 over water). Observations and Step 1 wind fields are weighted by means of parameters R1 at the surface and R2 aloft: at a distance R1 from an observation site, the Step 1 wind field and the surface observations are weighted equally. As noted above, RMAX1/R1 and RMAX2/R2 are set with 2:1 ratio. Vertical extrapolation for the surface meteorological stations was activated (IEXTRP=4), which is in agreement with the U.S. EPA (2009) recommendations. This setting insures that the surface observations, vertically extrapolated within the boundary layer, are blended with the MM5-based Step 1 field aloft.

4.2 Dispersion Modeling Options

CALPUFF simulations was conducted generally following the WRAP Protocol 2006 guidance, but with the EPA-approved Version 5.8 Level 070623 rather than Version 6 of the model. List of options used in the modeling includes:

- Gaussian near-field vertical distribution
- Partial plume path adjustment method for terrain
- Transitional plume rise modeled
- Partial plume penetration of elevated inversion option activated
- Stack tip downwash
- MESOPUFF II scheme for the chemical transformation
- Pasquill-Gifford (PG) dispersion coefficients (rural areas) and McElroy-Pooler coefficients (urban areas) used to compute dispersion coefficients. The probability density function (PDF) for convective conditions not used because this is available only with the turbulence-based dispersion option.
- Transition of σ_z to time-dependent (Heffter) growth rates set to 550 meters
- The switch for using Heffter equation for sigma z not activated
- PG sigma-y, z adjustment for roughness not selected
- Puff splitting (MSPLIT=1) activated
- Wet deposition, dry deposition applied
- The minimum turbulence velocities sigma-v for each stability class set to 0.5 m/s over land and 0.37 m/s over water.

The CALPUFF computational grid is the same as the meteorological grid. The modeling domain includes a buffer zone of 50 km around the source area and beyond the borders of the Class I areas. This minimizes edge effects and allows pollutants involved in flow reversals to be brought back into the Class I areas. Note that the CALMET modeling domain from previous studies was extended to include the Isle Royale National Park.

Two important computational parameters in CALPUFF are XMXLEN (maximum length of an emitted puff, in grid units) and XSAMLEN (maximum travel distance of a puff, in grid units, during one time step). Both of these variables were set to 1.0 in the CALPUFF simulations in order to allow the strong wind channeling effects to be accounted for in the puff trajectory calculations. The first parameter ensures that the length of an emitted puff does not become so large so that it cannot respond to changes in the wind field on the scale of the meteorological grid. The model automatically increases the frequency of puff releases to ensure the length of a single puff is not larger than the grid size. The second parameter decreases the internal time step to ensure the travel distance during one time step does not exceed the grid size.

The partial plume path adjustment option was used in CALPUFF for this analysis (MCTADJ=3). The CALMET wind field incorporates the effect of the terrain on the plume trajectories. The plume path coefficient was used to characterize the local effect on ground-level concentrations. The default plume path coefficients (PPC) was used for this analysis as listed below:

Stability Class	A	B	C	D	E	F
PPC	0.5	0.5	0.5	0.5	0.35	0.35

Deposition and chemical transformation effects were modeled using the default dry deposition model, the scavenging coefficient wet removal module, and the default chemical transformation mechanism.

A total of five chemically active species were modeled with CALPUFF for this analysis: SO₂, SO₄, NO_x, HNO₃ and NO₃. The chemical mechanism computes transformation rates of SO₂ to SO₄ and NO_x to NO₃/HNO₃. Hourly measured ozone concentrations were provided in an external file for use with the chemical transformation module. These ozone concentrations, along with radiation intensity, are used as surrogates for the OH concentration during the day when the gas phase free radical chemistry is active.

Six additional PM₁₀ species were modeled corresponding to the midpoint of each particle size bin shown in Table 2-2. The fine, coarse, elemental carbon and organic carbon species were constructed in postprocessing steps using the POSTUTIL program from these six PM species according to the appropriate size weights for size bin as discussed in Section 2.

4.3 Visibility Calculations

Calculations of the impact of the simulated plume particulate matter component concentrations on light extinction were carried out with the CALPOST postprocessor following the new proposed FLAG (2008) guidance. The original IMPROVE/EPA equation (1) described below was recommended to determine the change in light extinction due to changes in component concentrations. Using the notations of CALPOST:

$$B_{\text{ext}} = 3f(\text{RH})[(\text{NH}_4)_2\text{SO}_4] + 3f(\text{RH})[\text{NH}_4\text{NO}_3] + 4[\text{OC}] + 1[\text{Soil}] + 0.6[\text{Coarse Mass}] + 10[\text{EC}] + b_{\text{ray}} \quad (1)$$

The concentrations, in square brackets, are in $\mu\text{g}/\text{m}^3$ and b_{ext} is in units of Mm^{-1} .

But a revised new IMPROVE algorithm to compute the extinction ($1/\text{Mm}$) has been developed by the IMPROVE steering committee for estimating light extinction from particulate matter as described in equation (2) below. This algorithm provides a better correspondence between the measured visibility and that calculated from particulate matter component concentrations (Tombach, 2006):

$$\begin{aligned} b_{\text{ext}} = & 2.2 f_S(\text{RH}) \bullet [\text{small sulfate}] + 4.8 f_L(\text{RH}) \bullet [\text{large sulfate}] \\ & + 2.4 f_S(\text{RH}) \bullet [\text{small nitrate}] + 5.1 f_L(\text{RH}) \bullet [\text{large nitrate}] \\ & + 2.8 \bullet [\text{small organics}] + 6.1 \bullet [\text{large organics}] \\ & + 10 \bullet [\text{elemental carbon}] \\ & + 1 \bullet [\text{fine soil}] \\ & + 1.7 f_{\text{SS}}(\text{RH}) \bullet [\text{sea salt}] \\ & + 0.6 \bullet [\text{coarse matter}] \\ & + \text{Rayleigh scattering (site - specific)} \\ & + 0.17 \bullet [\text{NO}_2] \end{aligned} \quad (2)$$

All of the brackets [] denote concentrations in $\mu\text{g}/\text{m}^3$.

In CALPOST, the new IMPROVE algorithm as proposed by FLAG (2008) is implemented as CALPOST Method 8. The implementation of this method in CALPOST is described in more details in Appendix A. The proposed FLAG (2008) methodology is included in CALPOST V6.221 Level 080724, which has been reviewed and approved by the FLMS. This version of CALPOST is publicly available on the TRC's CALPUFF website (<http://www.src.com/calpuff/calpuff1.htm>) and was used for this analysis.

The Rayleigh scattering term (b_{ray}) is site-specific and computed as a function of the elevation as shown in Table 4-1, following FLAG (2008) guidance. Note that organic carbon (OC), which consists of condensable particulates and elemental carbon (EC) for soot particulates were modeled along with fine and coarse particulate matter as described in Section 2.

To represent background natural conditions, monthly background concentrations must be entered into the CALPOST input control file for all aerosols defining the background. The WRAP Protocol (2006) recommendations for natural conditions background are to use all three types of EPA default Natural Conditions: Best 20% Days, Annual Average and Worst 20% Days. In "Guidance for Estimating Visibility Conditions Under the Regional Haze Rule" (EPA, 2003), these three default values are defined only by their extinction coefficient in Mm^{-1} . For CALPOST Method 8, explicit background concentrations are required to allow the computation of the small and large sulfate particulates, nitrate particulates and organic carbon. So, in this analysis, the annual averaged background conditions were used to define the natural background for each of the seven Class I areas, following FLAG (2008). The concentrations used as background for each of the seven Class I areas are summarized in Table 4-2.

These concentrations were used to compute the natural background light extinction following the revised IMPROVE formulae described above, for each of the Class I areas.

Tables 4-3, 4-4, and 4-5, provide the monthly $f(RH)$ values for each of the seven Class I areas, that are used to compute extinction coefficients for hygroscopic species, respectively for small ammonium sulfate and ammonium nitrate particles, large ammonium sulfate and ammonium nitrate particles, and sea salt particles.

The 8th highest (98th percentile) predicted light extinction change for each year modeled was compared to the threshold value of 0.5 deciview.

Table 4-1. Rayleigh Scattering Term (Mm^{-1}) for each Class I area as a Function of Elevation

Class I Area	Highest Elevation in feet (meters)	Rayleigh Scattering Term (Mm^{-1})
Boundary Waters Canoe Area Wilderness	1998.0 (609)	11
Voyageurs NP	1335.3 (407)	12
Badlands NP	3031.5 (924)	11
Wind Cave NP	4796.6 (1462)	10
Lostwood NWR	2427.8 (740)	11
Theodore Roosevelt NP	2900.3 (884)	11
Isle Royale NP	1325.5 (404)	11

Source: FLAG (2008)

Table 4-2. Annual Averaged Conditions Levels of Aerosol Components ($\mu g/m^3$) to Define Natural Background (FLAG 2008) – Method 8 values per Class I Area

Class I Area	SO ₄	NO ₃	OC	EC	Soil	Coarse Mass
Boundary Waters Canoe Area Wilderness	0.23	0.10	1.71	0.02	0.31	2.53
Voyageurs NP	0.23	0.10	1.75	0.02	0.26	2.73
Badlands NP	0.12	0.10	0.60	0.02	0.50	3.00
Wind Cave NP	0.12	0.10	0.60	0.02	0.49	2.98
Lostwood NWR	0.12	0.10	0.60	0.02	0.50	3.00
Theodore Roosevelt NP	0.12	0.10	0.60	0.02	0.50	3.00
Isle Royale NP	0.23	0.10	1.55	0.02	0.24	2.89

Source: FLAG (2008)

Table 4-3. Monthly Site-Specific RH adjustment factors f(RH) values for hygroscopic species – Small ammonium sulfate and ammonium nitrate particles - Method 8 (FLAG, 2008)

Class I area	Jan	Feb	Mar	Apr	May	Jun	Jul	Aug	Sep	Oct	Nov	Dec
Boundary Waters CAW	3.23	2.81	2.93	2.63	2.89	3.22	3.44	3.71	3.83	3.08	3.49	3.49
Voyageurs NP	3.16	2.77	2.82	2.59	2.65	3.28	3.25	3.48	3.66	3.02	3.37	3.32
Badlands NP	2.94	2.96	3.01	2.87	3.10	2.91	2.64	2.59	2.56	2.58	3.11	2.98
Wind Cave NP	2.81	2.81	2.86	2.82	3.06	2.81	2.50	2.46	2.44	2.52	2.97	2.83
Lostwood NWR	3.21	3.15	3.36	2.60	2.54	2.86	2.89	2.60	2.53	2.72	3.60	3.52
Theodore Roosevelt NP	3.17	3.11	3.22	2.71	2.74	2.85	2.73	2.49	2.48	2.66	3.42	3.37
Isle Royale NP	3.26	2.74	2.87	2.58	2.46	3.00	3.59	3.68	3.92	2.88	3.72	3.67

Source: FLAG (2008)

Table 4-4. Monthly Site-Specific RH adjustment factors f(RH) values for hygroscopic species – Large ammonium sulfate and ammonium nitrate particles – Method 8 (FLAG, 2008)

Class I area	Jan	Feb	Mar	Apr	May	Jun	Jul	Aug	Sep	Oct	Nov	Dec
Boundary Waters CAW	2.50	2.25	2.28	2.09	2.20	2.43	2.57	2.71	2.78	2.38	2.64	2.64
Voyageurs NP	2.46	2.22	2.22	2.07	2.09	2.46	2.46	2.59	2.70	2.35	2.58	2.55
Badlands NP	2.31	2.31	2.31	2.21	2.34	2.25	2.08	2.05	2.02	2.05	2.38	2.33
Wind Cave NP	2.23	2.22	2.22	2.18	2.32	2.18	2.00	1.97	1.95	2.00	2.30	2.24
Lostwood NWR	2.51	2.45	2.54	2.06	2.03	2.21	2.23	2.05	2.02	2.13	2.69	2.67
Theodore Roosevelt NP	2.47	2.42	2.45	2.12	2.14	2.21	2.14	1.99	1.99	2.10	2.58	2.57
Isle Royale NP	2.53	2.21	2.26	2.07	1.99	2.32	2.65	2.69	2.82	2.28	2.76	2.74

Source: FLAG (2008)

Table 4-5. Monthly Site-Specific RH adjustment factors f(RH) values for hygroscopic species – Sea salt particles - Method 8 (FLAG, 2008)

Class I area	Jan	Feb	Mar	Apr	May	Jun	Jul	Aug	Sep	Oct	Nov	Dec
Boundary Waters CAW	3.73	3.35	3.29	2.91	3.00	3.44	3.68	3.88	3.98	3.45	3.89	3.91
Voyageurs NP	3.69	3.31	3.20	2.90	2.89	3.46	3.55	3.71	3.87	3.42	3.83	3.80
Badlands NP	3.37	3.33	3.27	3.05	3.25	3.15	2.89	2.81	2.74	2.82	3.41	3.38
Wind Cave NP	3.25	3.20	3.13	3.01	3.22	3.06	2.75	2.68	2.63	2.75	3.28	3.24
Lostwood NWR	3.77	3.66	3.67	2.86	2.79	3.07	3.11	2.82	2.80	2.99	3.93	3.95
Theodore Roosevelt NP	3.67	3.56	3.51	2.93	2.97	3.09	2.96	2.72	2.72	2.93	3.75	3.78
Isle Royale NP	3.78	3.34	3.28	2.93	2.78	3.31	3.83	3.87	4.06	3.40	4.05	4.04

Source: FLAG (2008)

5. RESULTS

The results for the BART analysis for the Big Stone I facility are presented in this section. The analysis consists of evaluating the visibility impact (percent change in light extinction due to the sources measured in deciview) at all the Class I areas modeled. The results for the base case are presented in three tables, each table gathering the impact at seven Class I areas for each of the years modeled: Table 5-1 for 2002, Table 5-2 for 2006 and Table 5-3 for 2007. The change in light extinction due to the source is compared to the annual average natural background light extinction. The interpretation of the results is done by comparing the 98th percentile of Delta deciview for each year to the 0.5 delta deciview threshold. Analysis is performed by using CALPOST Method 8.

Ammonia Limiting Method (ALM) with CMAQ 2002 monthly averages as background was performed as well. These results are presented in Tables 5-4 through 5-6.

Table 5-1. Visibility impacts for 2002. Constant (1 ppb) ammonia.

Park	Max Delta Deciview	4th Highest (99%)	8th Highest (98%)	Nb. Exceed. > 5%	Nb. Exceed. > 10%
Boundary Waters	1.315	0.837	0.574	14	1
Voyageurs	2.162	0.690	0.623	9	3
Wind Cave	0.873	0.475	0.305	3	0
Theodore Roosevelt	1.390	0.555	0.215	4	1
Lostwood National	0.564	0.388	0.232	2	0
Badlands	0.762	0.671	0.452	7	0
Isle Royale	1.182	0.789	0.629	10	2

Table 5-2. Visibility impacts for 2006. Constant (1 ppb) ammonia.

Park	Max Delta Deciview	4th Highest (99%)	8th Highest (98%)	Nb. Exceed. > 5%	Nb. Exceed. > 10%
Boundary Waters	2.572	1.183	0.790	16	5
Voyageurs	1.578	0.862	0.574	11	2
Wind Cave	0.454	0.302	0.120	0	0
Theodore Roosevelt	2.232	0.772	0.459	6	3
Lostwood National	1.110	0.662	0.385	5	1
Badlands	1.002	0.519	0.481	7	1
Isle Royale	1.806	0.635	0.506	8	2

Table 5-3. Visibility impacts for 2007. Constant (1 ppb) ammonia.

Park	Max Delta Deciview	4th Highest (99%)	8th Highest (98%)	Nb. Exceed. > 5%	Nb. Exceed. > 10%
Boundary Waters	3.574	1.351	1.079	25	9
Voyageurs	2.062	1.376	0.724	19	5
Wind Cave	1.671	0.591	0.325	4	2
Theodore Roosevelt	0.744	0.491	0.322	3	0
Lostwood National	0.959	0.722	0.409	6	0
Badlands	2.202	0.698	0.471	6	2
Isle Royale	1.224	0.745	0.665	13	2

Table 5-4. Visibility impacts with ALM considered for 2002.

Park	Max Delta Deciview	4th Highest (99%)	8th Highest (98%)	Nb. Exceed. > 5%	Nb. Exceed. > 10%
Boundary Waters	0.740	0.491	0.389	3	0
Voyageurs	1.256	0.546	0.380	4	1
Wind Cave	0.725	0.435	0.275	3	0
Theodore Roosevelt	1.355	0.472	0.181	2	1
Lostwood National	0.510	0.298	0.198	1	0
Badlands	0.714	0.617	0.422	7	0
Isle Royale	0.661	0.560	0.350	4	0

Table 5-5. Visibility impacts with ALM considered for 2006.

Park	Max Delta Deciview	4th Highest (99%)	8th Highest (98%)	Nb. Exceed. > 5%	Nb. Exceed. > 10%
Boundary Waters	1.439	0.830	0.550	10	3
Voyageurs	1.150	0.540	0.391	5	1
Wind Cave	0.319	0.191	0.111	0	0
Theodore Roosevelt	1.280	0.606	0.367	5	1
Lostwood National	0.673	0.521	0.377	4	0
Badlands	0.917	0.477	0.269	3	0
Isle Royale	0.805	0.467	0.352	1	0

Table 5-6. Visibility impacts with ALM considered for 2007.

Park	Max Delta Deciview	4th Highest (99%)	8th Highest (98%)	Nb. Exceed. > 5%	Nb. Exceed. > 10%
Boundary Waters	1.530	0.786	0.654	13	2
Voyageurs	1.357	0.714	0.553	9	1
Wind Cave	0.713	0.427	0.276	3	0
Theodore Roosevelt	0.724	0.388	0.278	2	0
Lostwood National	0.934	0.563	0.353	4	0
Badlands	1.042	0.571	0.353	5	1
Isle Royale	0.793	0.551	0.486	7	0

6. REFERENCES

- Carson, D.J., 1973: The development of a dry, inversion-capped, convectively unstable boundary layer. *Quart. J. Roy. Meteor. Soc.*, 99, 450-467.
- Escoffier-Czaja, C., and J. Scire, 2002: The Effects of Ammonia Limitation on Nitrate Aerosol Formation and Visibility Impacts in Class I Areas. Paper J5.13, 12th AMS/AWMA Conference on the Applications of Air Pollution Meteorology, Norfolk, VA, May 2002.
- Escoffier-Czaja, C. and J. Scire, 2007: Use of Eulerian Model outputs as background concentrations for Nitrate Predictions in CALPUFF system. 11th International Conference in Harmonisation within Atmospheric Dispersion Modeling for Regulatory Purposes, Cambridge, UK, July 2007.
- FLAG, 2000. Federal Land Manager' Air Quality Related Values Workgroup (FLAG). Phase I Report. U.S. Forest Service, National Park Service, U.S. Fish and Wildlife Service.
- FLAG, 2008. Federal Land Manager' Air Quality Related Values Workgroup (FLAG). Phase I Report - Revised. U.S. Forest Service, National Park Service, U.S. Fish and Wildlife Service, *June 27, 2008, Draft*.
- Maul, P.R., 1980: Atmospheric transport of sulfur compound pollutants. Central Electricity Generating Bureau MID/SSD/80/0026/R. Nottingham, England.
- Scire, J.S., D.G. Strimaitis, and R.J. Yamartino, 2000a: A User's Guide for the CALPUFF Dispersion Model (Version 5). Earth Tech, Inc., Concord, MA
- Scire, J.S., F.R. Robe, M.E. Fernau, and R.J. Yamartino, 2000b: A User's Guide for the CALMET Meteorological Model (Version 5). Earth Tech, Inc., Concord, MA.
- Tombach, I, 2006: Instructions: A Postprocessor for Recalculating CALPOST Visibility Outputs with the New IMPROVE Algorithm, Version 2, 14 October, 2006.
- U.S. EPA, 1998: Interagency Workgroup on Air Quality Modeling (IWAQM), Phase 2 Report: Summary Report and Recommendation for Modeling Long Range Transport and Impacts on Regional Visibility. EPA-454/R-98-019.
- U.S. EPA, 2000: Federal Register Notice dated April 21, 2001.
- U.S. EPA, 2003: Guidance for Estimating Natural Visibility Conditions Under the Regional Haze Program. EPA-454/B-03-005, September 2003.
- U. S. EPA, 2005: Regional Haze Regulations and Guidelines for Best Available Technology (BART) Determinations. *Fed. Reg./Vol. 70, No. 128/Wed. July 6, 2005, Rules and Regulations*, pp. 39104-39172. 40 CFR Part 51, FRL-7925-9, RIN AJ31.
- U.S. EPA, 2009: Clarification on EPA-FLM Recommended Settings for CALMET. EPA Memo by T. Fox dated August 31, 2009.

VISTAS, 2006: Protocol for the Application of the CALPUFF Model for Analysis of Best Available Retrofit Technology (BART), August 2006.

WRAP Air Quality Modeling Forum RMC, 2006: CALMET/CALPUFF Protocol for the BART Exemption Screening Analysis for Class I Areas in the Western United States, August 15, 2006.

APPENDIX A

CALPOST VISIBILITY METHOD 8

The revised visibility algorithm developed for the IMPROVE Steering Committee (IMPROVE 2005) as recommended by FLAG (2008) has been implemented in CALPOST. It differs from the previous IMPROVE algorithm as used in Method 2 and Method 6 in six areas:

- Extinction efficiencies of sulfates, nitrates, and organics vary with concentration, as there are distinct efficiencies for "small" and "large" particles and the ratio of small-to-large particle fraction decreases as the concentration increases. Furthermore, the extinction efficiency for sulfates no longer equals that for nitrates.
- A separate hygroscopic humidity enhancement factor curve is prescribed for "small" and "large" particles, $f_s(RH)$ and $f_l(RH)$. These curves apply to sulfates and nitrates.
- Light extinction due to scattering by sea salt (with its own hygroscopic humidity enhancement factor $f_{ss}(RH)$) is included.
- Light absorption by NO_2 gas is included in the extinction.
- Background particulate organic matter concentration is taken to be 1.8 times measured organic carbon concentrations.
- Rayleigh scattering extinction varies with site elevation and mean temperature.

Items 5 and 6 remain direct inputs to CALPOST, and required no structural changes to the postprocessor. The user must confirm that appropriate values are provided.

Item 4, the introduction of light extinction due to NO_2 gas absorption, has been added to CALPOST as a discrete component independent of the visibility method chosen. New control file inputs associated with NO_2 in the recommended FLAG (2008) mode are:

Source of NO_2 when ASPEC= NO_2 (above) or LVNO2=T (Group 2) may be from CALPUFF NO_2 concentrations OR from a fraction of CALPUFF NO_x concentrations. Specify the fraction of NO_x that is treated as NO_2 either as a constant or as a table of fractions that depend on the magnitude of the NO_x concentration:

```
(NO2CALC) -- Default: 1 ! NO2CALC = 1 !
0 = Use NO2 directly (NO2 must be in file)
1 = Specify a single NO2/NOx ratio (RNO2NOX)
2 = Specify a table NO2/NOx ratios (TNO2NOX)
(NOTE: Scaling Factors must NOT be used with NO2CALC=2)
```

Single NO_2/NO_x ratio (0.0 to 1.0) for treating some or all NO_x as NO_2 , where $[NO_2] = [NO_x] * RNO2NOX$
(used only if $NO_2CALC = 1$)

```
(RNO2NOX) -- Default: 1.0 ! RNO2NOX = 1.0 !
```

Items 1 through 3 are implemented as visibility Method 8 in CALPOST, along with the specific choice of the new $f(RH)$ curves. Selection of the revised IMPROVE algorithm requires the following new control file selections:

Particle growth curve f(RH) for hygroscopic species

(MFRH) -- Default: 2 ! MFRH = 4 !

- 1 = IWAQM (1998) f(RH) curve (originally used with MVISBK=1)
- 2 = FLAG (2000) f(RH) tabulation
- 3 = EPA (2003) f(RH) tabulation
- 4 = IMPROVE (2006) f(RH) tabulations for sea salt, and for small and large SULFATE and NITRATE particles; Used with Visibility Method 8 (MVISBK = 8)

Method used for background light extinction

(MVISBK) -- Default: 2 ! MVISBK = 8 !

- 1 = Supply single light extinction and hygroscopic fraction
- 2 = Compute extinction from speciated PM measurements (A)
- 3 = Compute extinction from speciated PM measurements (B)
- 4 = Read hourly transmissometer background extinction measurements
- 5 = Read hourly nephelometer background extinction measurements
- 6 = Compute extinction from speciated PM measurements
- 7 = Use observed weather or prognostic weather information for background extinction during weather events; otherwise, Method 2
- 8 = Compute extinction from speciated PM measurements using the IMPROVE (2006) variable extinction efficiency formulation (MFRH must be set to 4)
 - Split between small and large particle concentrations of SULFATES, NITRATES, and ORGANICS is a function of concentration and different extinction efficiencies are used for each
 - Source-induced change in visibility includes the increase in extinction of the background aerosol due to the change in the extinction efficiency that now depends on total concentration.
 - Fsmall(RH) and Flarge(RH) adjustments for small and large particles are applied to observed and modeled sulfate and nitrate concentrations
 - Fsalt(RH) adjustment for sea salt is applied to background sea salt concentrations
 - F(RH) factors are capped at F(RHMAX)
 - RH for Fsmall(RH), Flarge(RH), and Fsalt(RH) may be obtained from hourly data as in Method 2 or from the FLAG monthly RH adjustment factor used for Method 6 where EPA F(RH) tabulation is used to infer RH, or monthly Fsmall, Flarge, and Fsalt RH adjustment factors can be directly entered. Furthermore, a monthly RH factor may be applied to either hourly concentrations or daily concentrations to obtain the 24-hour extinction.

These choices are made using the M8_MODE selection.

Additional inputs used for MVISBK = 8:

Extinction coefficients for hygroscopic species (modeled and background) may be computed using hourly RH values and hourly modeled concentrations, or using monthly RH values inferred from the RHFAC adjustment factors and either hourly or daily modeled concentrations, or using monthly RHFSML, RHFLRG, and RHFSEA adjustment factors and either hourly or daily modeled concentrations.

(M8_MODE) -- Default: 5 ! M8_MODE= 5 !
FLAG (2008)

- 1 = Use hourly RH values from VISB.DAT file with hourly modeled and monthly background concentrations.
- 2 = Use monthly RH from monthly RHFAC and EPA (2003) f(RH) tabulation with hourly modeled and monthly background concentrations.
(VISB.DAT file is NOT needed).
- 3 = Use monthly RH from monthly RHFAC with EPA (2003) f(RH) tabulation with daily modeled and monthly background concentrations.
(VISB.DAT file is NOT needed).
- 4 = Use monthly RHFSML, RHFLRG, and RHFSEA with hourly modeled and monthly background concentrations.
(VISB.DAT file is NOT needed).
- 5 = Use monthly RHFSML, RHFLRG, and RHFSEA with daily modeled and monthly background concentrations.
(VISB.DAT file is NOT needed).

The last of these selections, M8_MODE, provides options for how concentrations are averaged, and how the relative humidity enhancement factors for hygroscopic species are determined. M8_MODE has a default value of 5, which is consistent with the new FLAG (2008) guidance

APPENDIX B

MM5 MODEL CONFIGURATION

MM5 Domain Configuration (36-km, 12-km Resolution)

The Fifth Generation Penn State University/NCAR Mesoscale Model (MM5) (Dudhia et al, 2000) has been run for 2006 and 2007 for North America for two domains: a coarse Domain 1 (36-km resolution), and a nested Domain 2 (12-km resolution). The Lambert Conical Conformal (LCC) mapping projection is used in modeling. The center of the coordinate system is located at the center of Domain 1 at 40°N and 98°W. Two standard latitudes of LCC are set to 20°N and 60°N. The coarse domain (Domain 1) covers an area of 7488 km in the west-east (X) direction by 6768 km in the south-north (Y) direction with grid spacing of 36 km (Table B-1). Figure B-1 shows Modeling Domains 1 and 2.

There are forty-one sigma levels in the vertical direction from the surface up to 100 hPa (Table B-2). The first sigma level is about 11 m above the ground, very close to the anemometer height at operational weather stations. The vertical spatial resolution varies from the surface to the model top. About twenty levels are below 1500 m above the ground for better resolving the atmospheric boundary layer in the model.

Model Parameterizations and Schemes

The MM5 model was run for 2006 and 2007 in the non-hydrostatic mode using the upper radiative boundary condition. MM5 physical schemes and parameterizations are listed in Table B-1. The Reisner graupel scheme was used for the explicit moisture parameterization. It predicts all five water contents in the atmosphere. This scheme includes additional equation to predict graupel. It is a more computationally expensive scheme compared with simple ice scheme. The cumulus scheme used in MM5 is the Kain-Fritsch 2 scheme (Kain, 2004). This scheme includes shallow convection. For planetary boundary layer (PBL) scheme, the Mellor-Yamada scheme used in the ETA model (Janjic, 1990, 1994) was used in this MM5 modeling. This scheme was implemented in the NCEP MRF model. It is efficient and suitable for high-resolution PBL. The Rapid Radiative Transfer Model was used for the radiation scheme in both Domains (Mlawer et al., 1997). This scheme is a highly accurate and efficient method developed by AER Inc. Multiple-layer soil temperatures were computed using the NOAH land surface model (National Centers for Environmental Prediction, Oregon State University, Air Force, and Hydrologic Research Laboratory). Additional geographical data, such as soil types, vegetation fraction, and annual deep soil temperatures are needed for the land surface model; and these data were obtained from NCAR.

One way nesting is used in the MM5 simulation, meaning that the mother domain is not affected by its child-domain. Such nesting allows adding new domains later without re-running all the other domains. Analysis Four Dimensional Data Assimilation (FDDA) was applied to both Domain 1 and Domain 2.

Table B-1 Domain Configuration and Parameterizations for 2006 and 2007 MM5 Simulations. The Lambert Conical Conformal (LCC) map projection is used in the MM5 modeling.

Settings	Domain 1	Domain 2
Grid number	209 x 189	388 x 250
Grid size (km)	36	12
Nesting	NA	One-way
Sigma levels	41	41
Moisture	Reisner 2	Reisner 2
Cumulus	Kain-Fritsch 2	Kain-Fritsch 2
Boundary layer	ETA	ETA
Radiation	RRTM	RRTM
Soil model	NOAH LSM	NOAH LSM
FDDA	3D and Surface Analysis	3D and Surface Analysis
Run Length	2.5 days	2.5 days
Spin-up time	12 hours	12 hours
Terrain and land-use data	USGS 10-minute (~19 km)	USGS 5-minute (~9 km)

USA MM5 Domain 4 (4-km) Coverage

**Map Projection: LCC; Center: 40N, 98W
Standards: 20N, 60N
Datum: NWS-84**

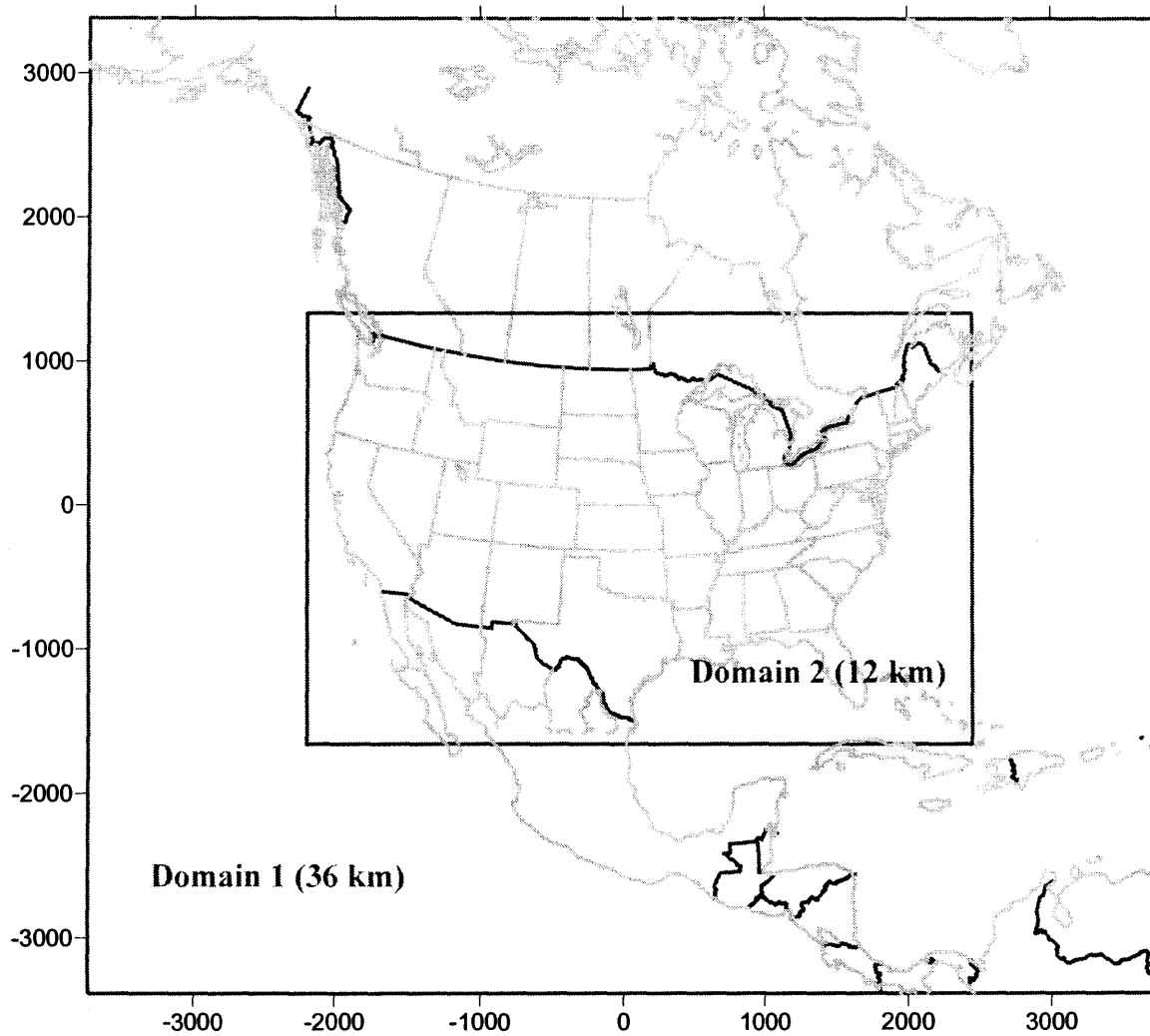

MM5 Domains:

D1: X: -3744 - 3744 km, Y: -3384 - 3384 km; dxy= 36 km; 209 x 189 i1= 1,j1= 1

D2: X: -2196 - 2448 km, Y: -1656 - 1332 km; dxy= 12 km; 388 x 250 i1= 44,j1= 49

D3: X: -612 - 864 km, Y: -48 - 1080 km; dxy= 4 km; 370 x 283 i1=133,j1=135

Figure B-1. Map showing the MM5 Domain 1 (36-km) and Domain 2 (12-km).

Table B-2. Sigma Levels used in the North American MM5 Simulations for 2006 and 2007.

Level	Sigma	Half Sigma	Ref. Pressure (mb)	Height (m)
surface	1.0000	-	1010.0	0.0
1	0.9970	0.9985	1008.6	10.9
2	0.9936	0.9953	1005.7	34.1
3	0.9898	0.9917	1002.4	60.3
4	0.9856	0.9877	998.8	89.6
5	0.9808	0.9832	994.7	122.5
6	0.9754	0.9781	990.1	160.0
7	0.9694	0.9724	984.9	202.1
8	0.9626	0.9660	979.1	249.6
9	0.9549	0.9588	972.5	303.7
10	0.9463	0.9506	965.0	364.8
11	0.9367	0.9415	956.8	433.5
12	0.9258	0.9313	947.4	511.5
13	0.9136	0.9197	936.9	600.1
14	0.8999	0.9068	925.1	700.4
15	0.8845	0.8922	911.9	814.4
16	0.8672	0.8759	897.0	944.1
17	0.8477	0.8575	880.3	1092.1
18	0.8258	0.8368	861.4	1261.5
19	0.8012	0.8135	840.3	1455.3
20	0.7736	0.7874	816.5	1677.7
21	0.7425	0.7581	789.8	1934.1
22	0.7076	0.7251	759.8	2230.9
23	0.6683	0.6880	726.0	2576.1
24	0.6242	0.6463	688.1	2980.0
25	0.5746	0.5994	645.5	3455.7
26	0.5188	0.5467	597.5	4021.9
27	0.4688	0.4938	549.4	4628.0
28	0.4284	0.4486	508.2	5180.4
29	0.3879	0.4082	471.4	5705.6
30	0.3474	0.3677	434.6	6265.0
31	0.3065	0.3270	397.5	6866.0
32	0.2620	0.2843	358.7	7545.5
33	0.2175	0.2398	318.2	8317.4
34	0.1675	0.1925	275.2	9224.7
35	0.1175	0.1425	229.7	10311.2
36	0.0783	0.0979	189.1	11426.7
37	0.0588	0.0686	162.4	12261.6
38	0.0392	0.0490	144.6	12875.1
39	0.0196	0.0294	126.8	13547.3
40	0.0000	0.0098	108.9	14290.2

Initial Data and Simulation

MM5 is initialized using the 1° x 1° Final Analysis (FNL) data from NCEP at NCAR. It is an improvement of the original 2.5-degree by 2.5-degree dataset. The FNL data were archived at NCAR with temporal resolution of six hours at the surface and 26 standard pressure levels under 10 hPa: 1000, 975, 950, 925, 900, 850, 800, 750, 700, 650, 600, 550, 500, 450, 400, 350, 300, 250, 200, 150, 100, 70, 50, 30, 20, and 10 hPa. The dataset includes two-dimensional variables of snow cover, sea surface temperature (SST), sea level pressure, and three-dimensional variables of temperature, geopotential height, U and V components, and relative humidity.

The SST spatial resolution of 1° x 1° in FNL data is too coarse in the coastal area. To improve SST in MM5, a better SST dataset, the daily 4-km MODIS SSTs, is ingested into the simulation. The MODIS (MODerate Resolution Imaging Spectroradiometer) SSTs are derived from the sensors onboard the NASA Terra and Aqua platforms. The MODIS SSTs include from both the sensors of mid-infrared (IR) and thermal IR channels. The product used in the simulation is the MODIS Global Level 3 Mapped mid-IR SSTs.

MM5 is run for 2.5-day periods with 12 hours for spin-up time. The initial FNL data are model output and already in the dynamically-consistent state. The spin-up time of 12 hours is enough to allow MM5 reach dynamical balance in its domains. The 2.5-day simulation length can reduce the divergence between forecasts and analyses. MM5 output covers the period from 2005123112 to 2007010111, so that any conversion between local and UTC times can be properly processed. There are 183 2.5-day simulations in total for the annual period.

Evaluation of model performance

The MM5 model output dataset was evaluated using observations from hourly and synoptic surface data available from the US National Climatic Data Center (NCDC) in Asheville, North Carolina. The locations of the stations used in the evaluation are shown in Figure 3-4. The statistical index used for the evaluation is the Index of Agreement (IOA) is defined as:

$$IOA = 1 - \left[\frac{IJ \cdot RMSE^2}{\sum_{j=1}^J \sum_{i=1}^I |P_j^i - M_o| + |O_j^i - M_o|} \right] \quad (1)$$

where RMSE is the Root Mean Square Error, and calculated using the equation

$$RMSE = \left[\frac{i}{IJ} \sum_{j=1}^J \sum_{i=1}^I (P_j^i - O_j^i)^2 \right]^{1/2} \quad (2)$$

P_j^i and O_j^i are the prediction and the observation at Station j and time i . M_o is the Mean Observations and equal to

$$M_o = \frac{1}{IJ} \sum_{j=1}^J \sum_{i=1}^I O_j^i \quad (3)$$

The other two quantities used in the evaluation are Mean Bias Error (B) and Gross Error (E). Mean Bias Error is calculated using

$$B = \frac{1}{IJ} \sum_{j=1}^J \sum_{i=1}^I (P_j^i - O_j^i) \quad (4)$$

Gross Error equals

$$E = \frac{1}{IJ} \sum_{j=1}^J \sum_{i=1}^I |P_j^i - O_j^i| \quad (5)$$

In their studies, Emery et al. (2001) and Tesche et al. (2001) provided benchmarks for MM5 model evaluation or for other three-dimensional mesoscale model evaluation based on MM5/RAMS model performance evaluation literature. The benchmarks are for wind speed, wind direction, temperature and specific humidity. These benchmarks are “not to assign a passing or failing grade to a particular meteorological modeling application, but rather to put its results into a useful context” (Tesche et al., 2002). It is not expected that all simulations will fall within the benchmarks, but rather the benchmarks are useful in comparing the results from various simulations in a quantitative manner. The benchmarks were designed to be used with large groups of stations in a given region or stations of a particular classification rather than with individual stations.

Table B-3 contains a summary of the statistical measures above comparing using hourly surface meteorological observations with the MM5 modeling results prepared by TRC for 2006 and 2007. Also included is a comparison of the results with the EPA-sponsored 2002 MM5 dataset which has been subject to previous model evaluations. The comparisons were done using the surface meteorological stations within the CALPUFF modeling domain, which consisted of 172, 210 and 210 stations for 2002, 2006 and 2007, respectively. The performance is similar for each of the datasets. The statistical measures are all better than the benchmark values, with the exception in the 2002 dataset of the mean gross error for temperature, which is slight above the benchmark, and the Index of Agreement (IOA), which is slightly lower than the benchmark.

Table B-3. Performance Statistics by Year – MM5 Simulations – 12-km Grid Resolution

	Wind Speed			Wind Direction		Temperature			Specific Humidity		
	Mean IOA	Mean Bias	Mean RMSE	Mean Bias	Mean Gross Error	Mean IOA	Mean Bias	Mean Gross Error	Mean IOA	Mean Bias	Mean Gross Error
2002	0.77	0.18	1.88	2.70	21.15	0.79	-0.05	2.75	0.84	-0.06	0.73
2006	0.83	0.04	1.54	1.76	16.68	0.96	-0.19	1.19	0.81	0.43	0.83
2007	0.83	0.14	1.59	2.31	17.05	0.96	-0.12	1.23	0.81	0.47	0.86
Benchmark	$x \geq 0.60$	$ x \leq 0.50$	$x \leq 2.00$	$ x \leq 10.0$	$x \leq 30.0$	$x \geq 0.80$	$ x \leq 0.50$	$x \leq 2.00$	$x \geq 0.60$	$ x \leq 1.00$	$x \leq 2.00$

References for Appendix B

- Dudhia, J., D. Gill, Y-R. Guo, D. Hassen, K. Manning, and W. Wang, 2000: PSU/NCAR Mesoscale Modeling System, Tutorial Class Notes and User's Guide: MM5 Modeling System Version 3, Mesoscale and Microscale Meteorology Division, National Center for Atmospheric Research.
- Emery C., E. Tai, and G. Yarwood, 2001: Enhanced meteorological modeling and performance evaluation for two Texas ozone episodes. Environ International Corporation, 101 Rowland Way, Suite 220, Novato, CA
- Janjic, I.Z., 1990: The step-mountain coordinate: Physical package. *Mon. Wea. Rev.*, **118**, 1429-1443.
- Janjic, I.Z., 1994: The step-mountain Eta coordinate model: Further developments of the convection, viscous sublayer, and turbulence closure scheme. *Mon. Wea. Rev.*, **122**, 927-945.
- Kain, J.S. and J.M. Fritsch, 1998: Multiple convective overturning in mesoscale convective systems: Reconciling observations, simulations, and theory. *Mon. Wea. Rev.*, **126**, 2254-2273.
- Kain, J.S., 2004: The Kain-Fritsch convective parameterization: An update. *J. of Appl. Meteor.*, **43**, 170-181
- Mlawer, E.J., S.J. Taubman, P.D. Brown, M.J. Iacono and S.A. Clough, 1997: Radiative transfer for inhomogeneous atmospheres: RRTM, a validated correlated k-model for the longwave. *J. Geophys. Res.*, **102**, 16,663-16,682.
- Tesche, T.W., D.E. McNally, C.A. Emery, E. Tai. 2001: Evaluation of the MM5 model over the Midwestern U.S. for three 8-hour oxidant episodes. Prepared for the Kansas City Ozone Technical Workgroup, by Alpine Geophysics, LLC, Ft. Wright, KY, and Environ International Corp., Novato, CA.
- Tesche, T.W., D.E. McNally and C. Tremback, 2002: Operational evaluation of the MM5 model over the Continental United States: Protocol for annual and episodic evaluation. Prepared for the Office of Air Quality Planning and Standards, U.S. EPA, Research Triangle Park, NC.

APPENDIX C

CALMET CONTROL FILE WITH MODEL SETTINGS

4 km resolution CALMET simulation
 BART Analysis
 Otter Tail Power Big Stone I 2006

----- Run title (3 lines) -----

CALMET MODEL CONTROL FILE

INPUT GROUP: 0 -- Input and Output File Names

Subgroup (a)

Default Name	Type	File Name
GEO.DAT	input	! GEODAT=geo-4km-hires.dat !
SURF.DAT	input	! SRFDAT=bs_surf2006ext.dat !
CLOUD.DAT	input	* CLDDAT= *
PRECIP.DAT	input	! PRCDAT=bs_precip-2006ext.dat !
WT.DAT	input	* WTDAT= *
CALMET.LST	output	! METLST=met2006_4km_a2r2_011.lst !
CALMET.DAT	output	! METDAT=met2006_4km_a2r2_011.dat !
PACOUT.DAT	output	* PACDAT= *

All file names will be converted to lower case if LCFILES = T
 Otherwise, if LCFILES = F, file names will be converted to UPPER CASE
 T = lower case ! LCFILES = T !
 F = UPPER CASE

NUMBER OF UPPER AIR & OVERWATER STATIONS:

Number of upper air stations (NUSTA) No default ! NUSTA = 10 !
 Number of overwater met stations
 (NOWSTA) No default ! NOWSTA = 2 !

NUMBER OF PROGNOSTIC and IGF-CALMET FILES:

Number of MM4/MM5/3D.DAT files
 (NM3D) No default ! NM3D = 1 !
 Number of IGF-CALMET.DAT files
 (NIGF) No default ! NIGF = 0 !

!END!

Subgroup (b)

Upper air files (one per station)

Default Name	Type	File Name
UP1.DAT	input	1 ! UPDAT= up-abr-2006n.dat! !END!
UP2.DAT	input	2 ! UPDAT= up-bis-2006n.dat! !END!
UP3.DAT	input	3 ! UPDAT= up-dvn-2006n.dat! !END!
UP4.DAT	input	4 ! UPDAT= up-ggw-2006n.dat! !END!
UP5.DAT	input	5 ! UPDAT= up-grb-2006n.dat! !END!
UP6.DAT	input	6 ! UPDAT= up-inl-2006n.dat! !END!
UP7.DAT	input	7 ! UPDAT= up-lbf-2006n.dat! !END!
UP8.DAT	input	8 ! UPDAT= up-mrx-2006n.dat! !END!
UP9.DAT	input	9 ! UPDAT= up-oax-2006n.dat! !END!
UP0.DAT	input	10 ! UPDAT= up-unr-2006n.dat! !END!

Subgroup (c)

Overwater station files (one per station)

Default Name	Type	File Name
SEA1.DAT	input	1 ! SEADAT= 45001-2006.dat! !END!
SEA2.DAT	input	2 ! SEADAT= 45006-2006.dat! !END!

Subgroup (d)

MM4/MM5/3D.DAT files (consecutive or overlapping)

Default Name	Type	File Name
--------------	------	-----------

MM5001 ! M3DDAT=../mm5_2006/mm5-200601.m3d! !END!

Subgroup (e)

IGF-CALMET.DAT files (consecutive or overlapping)

Default Name	Type	File Name
--------------	------	-----------

IGFn.DAT input 1 * IGFDAT=CALMET0.DAT * *END*

Subgroup (f)

Other file names

Default Name	Type	File Name
--------------	------	-----------

DIAG.DAT	input	* DIADAT= *
PROG.DAT	input	* PRGDAT= *

TEST.PRT	output	* TSTPRT= *
TEST.OUT	output	* TSTOUT= *
TEST.KIN	output	* TSTKIN= *
TEST.FRD	output	* TSTFRD= *
TEST.SLP	output	* TSTSLP= *
DCST.GRD	output	* DCSTGD= *

NOTES: (1) File/path names can be up to 70 characters in length
(2) Subgroups (a) and (f) must have ONE 'END' (surrounded by delimiters) at the end of the group
(3) Subgroups (b) through (e) are included ONLY if the corresponding number of files (NUSTA, NOWSTA, NM3D, NIGF) is not 0, and each must have an 'END' (surround by delimiters) at the end of EACH LINE

!END!

INPUT GROUP: 1 -- General run control parameters

Starting date:	Year (IBYR) -- No default	! IBYR= 2006 !
	Month (IBMO) -- No default	! IBMO= 1 !
	Day (IBDY) -- No default	! IBDY= 1 !
	Hour (IBHR) -- No default	! IBHR= 1 !

Note: IBHR is the time at the END of the first hour of the simulation
(IBHR=1, the first hour of a day, runs from 00:00 to 01:00)

Base time zone	(IBTZ) -- No default	! IBTZ= 7 !
PST = 08, MST = 07		
CST = 06, EST = 05		

Length of run (hours) (IRLG) -- No default	! IRLG= 120 !
--	---------------

Run type (IRTYPE) -- Default: 1	! IRTYPE= 1 !
---	---------------

0 = Computes wind fields only
1 = Computes wind fields and micrometeorological variables
(u*, w*, L, zi, etc.)
(IRTYPE must be 1 to run CALPUFF or CALGRID)

Compute special data fields required

by CALGRID (i.e., 3-D fields of W wind
components and temperature)
in addition to regular Default: T ! LCALGRD = T !
fields ? (LCALGRD)
(LCALGRD must be T to run CALGRID)

Flag to stop run after
SETUP phase (ITEST) Default: 2 ! ITEST= 2 !
(Used to allow checking
of the model inputs, files, etc.)
ITEST = 1 - STOPS program after SETUP phase
ITEST = 2 - Continues with execution of
COMPUTATIONAL phase after SETUP

Test options specified to see if
they conform to regulatory
values? (MREG) No Default ! MREG = 1 !

0 = NO checks are made
1 = Technical options must conform to USEPA guidance
IMIXH -1 Maul-Carson convective mixing height
over land; OCD mixing height overwater
ICOARE 0 OCD deltaT method for overwater fluxes
THRESHL 0.0 Threshold buoyancy flux over land needed
to sustain convective mixing height growth

!END!

INPUT GROUP: 2 -- Map Projection and Grid control parameters

Projection for all (X,Y):

Map projection
(PMAP) Default: UTM ! PMAP = LCC !

UTM : Universal Transverse Mercator
TTM : Tangential Transverse Mercator
LCC : Lambert Conformal Conic
PS : Polar Stereographic
EM : Equatorial Mercator
LAZA : Lambert Azimuthal Equal Area

False Easting and Northing (km) at the projection origin
(Used only if PMAP= TTM, LCC, or LAZA)
(FEAST) Default=0.0 ! FEAST = 0.000 !
(FNORTH) Default=0.0 ! FNORTH = 0.000 !

UTM zone (1 to 60)
(Used only if PMAP=UTM)
(IUTMZN) No Default ! IUTMZN = 0 !

Hemisphere for UTM projection?
(Used only if PMAP=UTM)
(UTMHEM) Default: N ! UTMHEM = N !
N : Northern hemisphere projection
S : Southern hemisphere projection

Latitude and Longitude (decimal degrees) of projection origin
(Used only if PMAP= TTM, LCC, PS, EM, or LAZA)
(RLAT0) No Default ! RLAT0 = 40N !
(RLON0) No Default ! RLON0 = 98W !

TTM : RLON0 identifies central (true N/S) meridian of projection
RLAT0 selected for convenience
LCC : RLON0 identifies central (true N/S) meridian of projection
RLAT0 selected for convenience
PS : RLON0 identifies central (grid N/S) meridian of projection
RLAT0 selected for convenience
EM : RLON0 identifies central meridian of projection

RLAT0 is REPLACED by 0.0N (Equator)
LAZA: RLON0 identifies longitude of tangent-point of mapping plane
RLAT0 identifies latitude of tangent-point of mapping plane

Matching parallel(s) of latitude (decimal degrees) for projection
(Used only if PMAP= LCC or PS)

(XLAT1) No Default ! XLAT1 = 20N !
(XLAT2) No Default ! XLAT2 = 60N !

LCC : Projection cone slices through Earth's surface at XLAT1 and XLAT2
PS : Projection plane slices through Earth at XLAT1
(XLAT2 is not used)

Note: Latitudes and longitudes should be positive, and include a
letter N,S,E, or W indicating north or south latitude, and
east or west longitude. For example,
35.9 N Latitude = 35.9N
118.7 E Longitude = 118.7E

Datum-region

The Datum-Region for the coordinates is identified by a character
string. Many mapping products currently available use the model of the
Earth known as the World Geodetic System 1984 (WGS-84). Other local
models may be in use, and their selection in CALMET will make its output
consistent with local mapping products. The list of Datum-Regions with
official transformation parameters is provided by the National Imagery and
Mapping Agency (NIMA).

NIMA Datum - Regions(Examples)

WGS-84 WGS-84 Reference Ellipsoid and Geoid, Global coverage (WGS84)
NAS-C NORTH AMERICAN 1927 Clarke 1866 Spheroid, MEAN FOR CONUS (NAD27)
NAR-C NORTH AMERICAN 1983 GRS 80 Spheroid, MEAN FOR CONUS (NAD83)
NWS-84 NWS 6370KM Radius, Sphere
ESR-S ESRI REFERENCE 6371KM Radius, Sphere

Datum-region for output coordinates
(DATUM) Default: WGS-84 ! DATUM = NWS-84 !

Horizontal grid definition:

Rectangular grid defined for projection PMAP,
with X the Easting and Y the Northing coordinate

No. X grid cells (NX) No default ! NX = 313 !
No. Y grid cells (NY) No default ! NY = 181 !

Grid spacing (DGRIDKM) No default ! DGRIDKM = 4. !
Units: km

Reference grid coordinate of
SOUTHWEST corner of grid cell (1,1)

X coordinate (XORIGKM) No default ! XORIGKM = -506. !
Y coordinate (YORIGKM) No default ! YORIGKM = 298. !
Units: km

Vertical grid definition:

No. of vertical layers (NZ) No default ! NZ = 10 !

Cell face heights in arbitrary
vertical grid (ZFACE(NZ+1)) No defaults
Units: m
! ZFACE = 0.,20.,40.,80.,160.,320.,640.,1200.,2000.,3000.,4000. !

!END!

INPUT GROUP: 3 -- Output Options

DISK OUTPUT OPTION

Save met. fields in an unformatted
output file ? (LSAVE) Default: T ! LSAVE = T !
(F = Do not save, T = Save)

Type of unformatted output file:
(IFORMO) Default: 1 ! IFORMO = 1 !

1 = CALPUFF/CALGRID type file (CALMET.DAT)
2 = MESOPUFF-II type file (PACOUT.DAT)

LINE PRINTER OUTPUT OPTIONS:

Print met. fields ? (LPRINT) Default: F ! LPRINT = F !
(F = Do not print, T = Print)
(NOTE: parameters below control which
met. variables are printed)

Print interval
(IPRINF) in hours Default: 1 ! IPRINF = 1 !
(Meteorological fields are printed
every 1 hours)

Specify which layers of U, V wind component
to print (IUVOUT(NZ)) -- NOTE: NZ values must be entered
(0=Do not print, 1=Print)
(used only if LPRINT=T) Defaults: NZ*0 ! IUVOUT = 10*0 !

Specify which levels of the W wind component to print
(NOTE: W defined at TOP cell face -- 10 values)
(IWOUT(NZ)) -- NOTE: NZ values must be entered
(0=Do not print, 1=Print)
(used only if LPRINT=T & LCALGRD=T)

Defaults: NZ*0 ! IWOUT = 10*0 !

Specify which levels of the 3-D temperature field to print
(ITOUT(NZ)) -- NOTE: NZ values must be entered
(0=Do not print, 1=Print)
(used only if LPRINT=T & LCALGRD=T)

Defaults: NZ*0 ! ITOUT = 10*0 !

Specify which meteorological fields
to print
(used only if LPRINT=T) Defaults: 0 (all variables)

Variable	Print ? (0 = do not print, 1 = print)	
! STABILITY	= 0	! - PGT stability class
! USTAR	= 0	! - Friction velocity
! MONIN	= 0	! - Monin-Obukhov length
! MIXHT	= 0	! - Mixing height
! WSTAR	= 0	! - Convective velocity scale
! PRECIP	= 0	! - Precipitation rate
! SENSHEAT	= 0	! - Sensible heat flux

! CONVZI = 0 ! - Convective mixing ht.

Testing and debug print options for micrometeorological module

Print input meteorological data and
internal variables (LDB) Default: F ! LDB = F !
(F = Do not print, T = print)
(NOTE: this option produces large amounts of output)

First time step for which debug data
are printed (NN1) Default: 1 ! NN1 = 1 !

Last time step for which debug data
are printed (NN2) Default: 1 ! NN2 = 1 !

Print distance to land
internal variables (LDBCST) Default: F ! LDBCST = F !
(F = Do not print, T = print)
(Output in .GRD file DCST.GRD, defined in input group 0)

Testing and debug print options for wind field module
(all of the following print options control output to
wind field module's output files: TEST.PRT, TEST.OUT,
TEST.KIN, TEST.FRD, and TEST.SLP)

Control variable for writing the test/debug
wind fields to disk files (IOUTD)
(0=Do not write, 1=write) Default: 0 ! IOUTD = 0 !

Number of levels, starting at the surface,
to print (NZPRN2) Default: 1 ! NZPRN2 = 0 !

Print the INTERPOLATED wind components ?
(IPR0) (0=no, 1=yes) Default: 0 ! IPR0 = 0 !

Print the TERRAIN ADJUSTED surface wind
components ?
(IPR1) (0=no, 1=yes) Default: 0 ! IPR1 = 0 !

Print the SMOOTHED wind components and
the INITIAL DIVERGENCE fields ?
(IPR2) (0=no, 1=yes) Default: 0 ! IPR2 = 0 !

Print the FINAL wind speed and direction
fields ?
(IPR3) (0=no, 1=yes) Default: 0 ! IPR3 = 0 !

Print the FINAL DIVERGENCE fields ?
(IPR4) (0=no, 1=yes) Default: 0 ! IPR4 = 0 !

Print the winds after KINEMATIC effects
are added ?
(IPR5) (0=no, 1=yes) Default: 0 ! IPR5 = 0 !

Print the winds after the FROUDE NUMBER
adjustment is made ?
(IPR6) (0=no, 1=yes) Default: 0 ! IPR6 = 0 !

Print the winds after SLOPE FLOWS
are added ?
(IPR7) (0=no, 1=yes) Default: 0 ! IPR7 = 0 !

Print the FINAL wind field components ?
(IPR8) (0=no, 1=yes) Default: 0 ! IPR8 = 0 !

!END!

INPUT GROUP: 4 -- Meteorological data options

NO OBSERVATION MODE (NOOBS) Default: 0 ! NOOBS = 0 !
0 = Use surface, overwater, and upper air stations
1 = Use surface and overwater stations (no upper air observations)
Use MM4/MM5/3D for upper air data
2 = No surface, overwater, or upper air observations
Use MM4/MM5/3D for surface, overwater, and upper air data

NUMBER OF SURFACE & PRECIP. METEOROLOGICAL STATIONS

Number of surface stations (NSSTA) No default ! NSSTA = 250 !
Number of precipitation stations
(NPSTA=-1: flag for use of MMS/3D precip data)
(NPSTA) No default ! NPSTA = 267 !

CLOUD DATA OPTIONS

Gridded cloud fields:
(ICLOUD) Default: 0 ! ICLOUD = 0 !
ICLOUD = 0 - Gridded clouds not used
ICLOUD = 1 - Gridded CLOUD.DAT generated as OUTPUT
ICLOUD = 2 - Gridded CLOUD.DAT read as INPUT
ICLOUD = 3 - Gridded cloud cover computed from prognostic fields

FILE FORMATS

Surface meteorological data file format
(IFORMS) Default: 2 ! IFORMS = 2 !
(1 = unformatted (e.g., SMERGE output))
(2 = formatted (free-formatted user input))
Precipitation data file format
(IFORMP) Default: 2 ! IFORMP = 2 !
(1 = unformatted (e.g., PMERGE output))
(2 = formatted (free-formatted user input))
Cloud data file format
(IFORMC) Default: 2 ! IFORMC = 2 !
(1 = unformatted - CALMET unformatted output)
(2 = formatted - free-formatted CALMET output or user input)

!END!

INPUT GROUP: 5 -- Wind Field Options and Parameters

WIND FIELD MODEL OPTIONS

Model selection variable (IWFCOD) Default: 1 ! IWFCOD = 1 !
0 = Objective analysis only
1 = Diagnostic wind module
Compute Froude number adjustment
effects ? (IFRADJ) Default: 1 ! IFRADJ = 1 !
(0 = NO, 1 = YES)
Compute kinematic effects ? (IKINE) Default: 0 ! IKINE = 0 !
(0 = NO, 1 = YES)
Use O'Brien procedure for adjustment
of the vertical velocity ? (IOBR) Default: 0 ! IOBR = 0 !
(0 = NO, 1 = YES)
Compute slope flow effects ? (ISLOPE) Default: 1 ! ISLOPE = 1 !
(0 = NO, 1 = YES)
Extrapolate surface wind observations
to upper layers ? (IEXTRP) Default: -4 ! IEXTRP = -4 !
(1 = no extrapolation is done,
2 = power law extrapolation used,
3 = user input multiplicative factors
for layers 2 - NZ used (see FEXTRP array)
4 = similarity theory used
-1, -2, -3, -4 = same as above except layer 1 data

at upper air stations are ignored

Extrapolate surface winds even
if calm? (ICALM) Default: 0 ! ICALM = 0 !
(0 = NO, 1 = YES)

Layer-dependent biases modifying the weights of
surface and upper air stations (BIAS(NZ))

-1<=BIAS<=1
Negative BIAS reduces the weight of upper air stations
(e.g. BIAS=-0.1 reduces the weight of upper air stations
by 10%; BIAS= -1, reduces their weight by 100 %)
Positive BIAS reduces the weight of surface stations
(e.g. BIAS= 0.2 reduces the weight of surface stations
by 20%; BIAS=1 reduces their weight by 100%)
Zero BIAS leaves weights unchanged (1/R**2 interpolation)
Default: NZ*0

! BIAS = 10*0 !

Minimum distance from nearest upper air station
to surface station for which extrapolation
of surface winds at surface station will be allowed
(RMIN2: Set to -1 for IEXTRP = 4 or other situations
where all surface stations should be extrapolated)

Default: 4. ! RMIN2 = -1.0 !

Use gridded prognostic wind field model
output fields as input to the diagnostic
wind field model (IPROG)

Default: 0 ! IPROG = 14 !
(0 = No, [IWFCOD = 0 or 1])
1 = Yes, use CSUMM prog. winds as Step 1 field, [IWFCOD = 0]
2 = Yes, use CSUMM prog. winds as initial guess field [IWFCOD = 1]
3 = Yes, use winds from MM4.DAT file as Step 1 field [IWFCOD = 0]
4 = Yes, use winds from MM4.DAT file as initial guess field [IWFCOD = 1]
5 = Yes, use winds from MM4.DAT file as observations [IWFCOD = 1]
13 = Yes, use winds from MM5/3D.DAT file as Step 1 field [IWFCOD = 0]
14 = Yes, use winds from MM5/3D.DAT file as initial guess field [IWFCOD = 1]
15 = Yes, use winds from MM5/3D.DAT file as observations [IWFCOD = 1]

Timestep (hours) of the prognostic
model input data (ISTEPPG)

Default: 1 ! ISTEPPG = 1 !

Use coarse CALMET fields as initial guess fields (IGFMET)
(overwrites IGF based on prognostic wind fields if any)

Default: 0 ! IGFMET = 0 !

RADIUS OF INFLUENCE PARAMETERS

Use varying radius of influence Default: F ! LVARY = F!
(if no stations are found within RMAX1,RMAX2,
or RMAX3, then the closest station will be used)

Maximum radius of influence over land
in the surface layer (RMAX1) No default ! RMAX1 = 100. !
Units: km

Maximum radius of influence over land
aloft (RMAX2) No default ! RMAX2 = 200. !
Units: km

Maximum radius of influence over water
(RMAX3) No default ! RMAX3 = 200. !
Units: km

OTHER WIND FIELD INPUT PARAMETERS

Minimum radius of influence used in
the wind field interpolation (RMIN) Default: 0.1 ! RMIN = 0.1 !
Units: km

Radius of influence of terrain
features (TERRAD) No default ! TERRAD = 15. !
Units: km

Relative weighting of the first
guess field and observations in the

```

0 = Compute internally from
    hourly surface observations
1 = Read preprocessed values from
    a data file (DIAG.DAT)

Surface met. station to use for
the surface temperature (ISURFT) No default    ! ISURFT = 211 !
(Must be a value from 1 to NSSTA)
(Used only if IDIOPT1 = 0)
-----

Domain-averaged temperature lapse
rate (IDIOPT2)                      Default: 0    ! IDIOPT2 = 0 !
0 = Compute internally from
    twice-daily upper air observations
1 = Read hourly preprocessed values
    from a data file (DIAG.DAT)

Upper air station to use for
the domain-scale lapse rate (IUPT) No default    ! IUPT = 1 !
(Must be a value from 1 to NUSTA)
(Used only if IDIOPT2 = 0)
-----

Depth through which the domain-scale
lapse rate is computed (ZUPT)      Default: 200. ! ZUPT = 200. !
(Used only if IDIOPT2 = 0)         Units: meters
-----

Domain-averaged wind components
(IDIOPT3)                          Default: 0    ! IDIOPT3 = 0 !
0 = Compute internally from
    twice-daily upper air observations
1 = Read hourly preprocessed values
    a data file (DIAG.DAT)

Upper air station to use for
the domain-scale winds (IUPWND)    Default: -1   ! IUPWND = -1 !
(Must be a value from -1 to NUSTA)
(Used only if IDIOPT3 = 0)
-----

Bottom and top of layer through
which the domain-scale winds
are computed
(ZUPWND(1), ZUPWND(2))             Defaults: 1., 1000. ! ZUPWND= 1., 1000. !
(Used only if IDIOPT3 = 0)         Units: meters
-----

Observed surface wind components
for wind field module (IDIOPT4)    Default: 0    ! IDIOPT4 = 0 !
0 = Read WS, WD from a surface
    data file (SURF.DAT)
1 = Read hourly preprocessed U, V from
    a data file (DIAG.DAT)

Observed upper air wind components
for wind field module (IDIOPT5)    Default: 0    ! IDIOPT5 = 0 !
0 = Read WS, WD from an upper
    air data file (UP1.DAT, UP2.DAT, etc.)
1 = Read hourly preprocessed U, V from
    a data file (DIAG.DAT)

LAKE BREEZE INFORMATION

Use Lake Breeze Module (LLBREZE)
                                Default: F    ! LLBREZE = F !

Number of lake breeze regions (NBOX)
                                ! NBOX = 0 !

X Grid line 1 defining the region of interest
                                ! XG1 = 0. !

X Grid line 2 defining the region of interest
                                ! XG2 = 0. !

```

Y Grid line 1 defining the region of interest ! YG1 = 0. !
 Y Grid line 2 defining the region of interest ! YG2 = 0. !

 X Point defining the coastline (Straight line)
 (XBCST) (KM) Default: none ! XBCST = 0. !

 Y Point defining the coastline (Straight line)
 (YBCST) (KM) Default: none ! YBCST = 0. !

 X Point defining the coastline (Straight line)
 (XECST) (KM) Default: none ! XECST = 0. !

 Y Point defining the coastline (Straight line)
 (YECST) (KM) Default: none ! YECST = 0. !

 Number of stations in the region Default: none ! NLB = 0 !
 (Surface stations + upper air stations)

 Station ID's in the region (METBXID(NLB))
 (Surface stations first, then upper air stations)
 ! METBXID = 0 !

!END!

 INPUT GROUP: 6 -- Mixing Height, Temperature and Precipitation Parameters

EMPIRICAL MIXING HEIGHT CONSTANTS

Neutral, mechanical equation
 (CONSTB) Default: 1.41 ! CONSTB = 1.41 !
 Convective mixing ht. equation
 (CONSTE) Default: 0.15 ! CONSTE = 0.15 !
 Stable mixing ht. equation
 (CONSTN) Default: 2400. ! CONSTN = 2400. !
 Overwater mixing ht. equation
 (CONSTW) Default: 0.16 ! CONSTW = 0.16 !
 Absolute value of Coriolis
 parameter (FCORIOL) Default: 1.E-4 ! FCORIOL = 1.0E-04!
 Units: (1/s)

SPATIAL AVERAGING OF MIXING HEIGHTS

Conduct spatial averaging
 (IAVEZI) (0=no, 1=yes) Default: 1 ! IAVEZI = 1 !

 Max. search radius in averaging
 process (MNMDAV) Default: 1 ! MNMDAV = 1 !
 Units: Grid
 cells

 Half-angle of upwind looking cone
 for averaging (HAFANG) Default: 30. ! HAFANG = 30. !
 Units: deg.

 Layer of winds used in upwind
 averaging (ILEVZI) Default: 1 ! ILEVZI = 1 !
 (must be between 1 and NZ)

CONVECTIVE MIXING HEIGHT OPTIONS:

Method to compute the convective
 mixing height (IMHXH) Default: 1 ! IMHXH = -1 !
 1: Maul-Carson for land and water cells
 -1: Maul-Carson for land cells only -
 OCD mixing height overwater
 2: Batchvarova and Gryning for land and water cells
 -2: Batchvarova and Gryning for land cells only
 OCD mixing height overwater

Threshold buoyancy flux required to
sustain convective mixing height growth
overland (THRESHL) Default: 0.0 ! THRESHL = 0.0 !
(expressed as a heat flux units: W/m3
per meter of boundary layer)

Threshold buoyancy flux required to
sustain convective mixing height growth
overwater (THRESHW) Default: 0.05 ! THRESHW = 0.05 !
(expressed as a heat flux units: W/m3
per meter of boundary layer)

Option for overwater lapse rates used
in convective mixing height growth
(ITWPROG) Default: 0 ! ITWPROG = 0 !
0 : use SEA.DAT lapse rates and deltaT (or assume neutral
conditions if missing)
1 : use prognostic lapse rates (only if IPROG>2)
and SEA.DAT deltaT (or neutral if missing)
2 : use prognostic lapse rates and prognostic delta T
(only if iprog>12 and 3D.DAT version# 2.0 or higher)

Land Use category ocean in 3D.DAT datasets
(ILUOC3D) Default: 16 ! ILUOC3D = 16 !
Note: if 3D.DAT from MM5 version 3.0, iluoc3d = 16
if MM4.DAT, typically iluoc3d = 7

OTHER MIXING HEIGHT VARIABLES

Minimum potential temperature lapse
rate in the stable layer above the
current convective mixing ht.
(DPTMIN) Default: 0.001 ! DPTMIN = 0.001 !
Units: deg. K/m
Depth of layer above current conv.
mixing height through which lapse
rate is computed (DZZI) Default: 200. ! DZZI = 200. !
Units: meters
Minimum overland mixing height
(ZIMIN) Default: 50. ! ZIMIN = 50. !
Units: meters
Maximum overland mixing height
(ZIMAX) Default: 3000. ! ZIMAX = 3000. !
Units: meters
Minimum overwater mixing height
(ZIMINW) -- (Not used if observed
overwater mixing hts. are used) Default: 50. ! ZIMINW = 50. !
Units: meters
Maximum overwater mixing height
(ZIMAXW) -- (Not used if observed
overwater mixing hts. are used) Default: 3000. ! ZIMAXW = 3000. !
Units: meters

OVERWATER SURFACE FLUXES METHOD and PARAMETERS

(ICOARE) Default: 10 ! ICOARE = 0 !
0: original deltaT method (OCD)
10: COARE with no wave parameterization (jwave=0, Charnock)
11: COARE with wave option jwave=1 (Oost et al.)
and default wave properties
-11: COARE with wave option jwave=1 (Oost et al.)
and observed wave properties (must be in SEA.DAT files)
12: COARE with wave option 2 (Taylor and Yelland)
and default wave properties
-12: COARE with wave option 2 (Taylor and Yelland)
and observed wave properties (must be in SEA.DAT files)

Note: When ICOARE=0, similarity wind profile stability PSI functions
based on Van Ulden and Holtslag (1985) are substituted for
later formulations used with the COARE module, and temperatures
used for surface layer parameters are obtained from either the
nearest surface station temperature or prognostic model 2D
temperatures (if ITWPROG=2).

Coastal/Shallow water length scale (DSHELF)
(for modified z0 in shallow water)

```

( COARE fluxes only)
                                Default : 0.      ! DSHELF = 0. !
                                units: km
COARE warm layer computation (IWARM)      ! IWARM = 0  !
1: on - 0: off (must be off if SST measured with
IR radiometer)                          Default: 0
COARE cool skin layer computation (ICOOL)  ! ICOOL = 0  !
1: on - 0: off (must be off if SST measured with
IR radiometer)                          Default: 0

```

TEMPERATURE PARAMETERS

```

3D temperature from observations or
from prognostic data? (ITPROG)           Default:0      ! ITPROG = 0  !

0 = Use Surface and upper air stations
    (only if NOOBS = 0)
1 = Use Surface stations (no upper air observations)
    Use MM5/3D for upper air data
    (only if NOOBS = 0,1)
2 = No. surface or upper air observations
    Use MM5/3D for surface and upper air data
    (only if NOOBS = 0,1,2)

Interpolation type
(1 = 1/R ; 2 = 1/R**2)                   Default:1      ! IRAD = 1  !

Radius of influence for temperature
interpolation (TRADKM)                    Default: 500.  ! TRADKM = 500. !
Units: km

Maximum Number of stations to include
in temperature interpolation (NUMTS)       Default: 5      ! NUMTS = 5  !

Conduct spatial averaging of temp-
eratures (IAVET) (0=no, 1=yes)           Default: 1      ! IAVET = 1  !
(will use mixing ht MNMDAV,HAFANG
so make sure they are correct)

Default temperature gradient
below the mixing height over
water (TGDEFB)                            Default: -.0098 ! TGDEFB = -0.0098 !
Units: K/m

Default temperature gradient
above the mixing height over
water (TGDEFA)                            Default: -.0045 ! TGDEFA = -0.0045 !
Units: K/m

Beginning (JWAT1) and ending (JWAT2)
land use categories for temperature
interpolation over water -- Make
bigger than largest land use to disable   ! JWAT1 = 55  !
                                           ! JWAT2 = 55  !

```

PRECIP INTERPOLATION PARAMETERS

```

Method of interpolation (NFLAGP)           Default: 2      ! NFLAGP = 2  !
(1=1/R,2=1/R**2,3=EXP/R**2)
Radius of Influence (SIGMAP)              Default: 100.0 ! SIGMAP = 100. !
(0.0 => use half dist. btwn
nearest stns w & w/out
precip when NFLAGP = 3)
Minimum Precip. Rate Cutoff (CUTP)       Default: 0.01  ! CUTP = 0.01 !
(values < CUTP = 0.0 mm/hr)              Units: mm/hr

```

!END!

INPUT GROUP: 7 -- Surface meteorological station parameters

SURFACE STATION VARIABLES

(One record per station -- 250 records in all)

1 2

Name	ID	X coord. (km)	Y coord. (km)	Time zone	Anem. Ht. (m)
! SS1	'CYBR'	711400,	-132.737961	1040.684570	7 10 !
! SS002	'CWNK'	711470,	-2.262997	995.140137	7 10 !
! SS003	'CWPO'	711480,	-62.049206	963.792969	7 10 !
! SS004	'CWZE'	711700,	-91.927345	1038.115110	7 10 !
! SS005	'CWDV'	714350,	520.234131	968.333252	7 10 !
! SS006	'CWGN'	714410,	29.940273	945.930359	7 10 !
! SS007	'CWEI'	714470,	-205.322525	975.742554	7 10 !
! SS008	'CWSU'	714490,	165.977509	946.451843	7 10 !
! SS009	'CWWF'	714520,	-396.077026	1029.438350	7 10 !
! SS010	'EMER'	715600,	53.065262	942.609009	7 10 !
! SS011	'CXMD'	715640,	-5.724126	961.681702	7 10 !
! SS012	'WINN'	715790,	59.056881	1035.899780	7 10 !
! SS013	'CZHD'	715820,	357.821838	1039.401120	7 10 !
! SS014	'ATIK'	717470,	441.910736	933.946167	7 10 !
! SS015	'CXDW'	718400,	-21.778795	984.620911	7 10 !
! SS016	'CYHD'	718425,	358.876953	1041.158940	7 10 !
! SS017	'CXWN'	718430,	59.056881	1035.899780	7 10 !
! SS018	'WASP'	718490,	52.213905	1039.430420	7 10 !
! SS019	'CYQK'	718500,	247.840500	1030.198360	7 10 !
! SS020	'CYPG'	718510,	-18.181787	1037.431640	7 10 !
! SS021	'CYWG'	718520,	52.229706	1037.633420	7 10 !
! SS022	'CYEN'	718620,	-342.161255	975.010742	7 10 !
! SS023	'KHZX'	720258,	337.785278	701.057190	7 10 !
! SS024	'KFKA'	720283,	440.500244	398.718048	7 10 !
! SS025	'KIIB'	720293,	465.955536	272.288361	7 10 !
! SS026	'KVTI'	720326,	462.249084	247.538208	7 10 !
! SS027	'KLUM'	720327,	454.199249	527.013367	7 10 !
! SS028	'KCKP'	720344,	187.478500	287.882965	7 10 !
! SS029	'KPEX'	720367,	239.019058	565.214783	7 10 !
! SS030	'KDVP'	720368,	166.747665	418.091461	7 10 !
! SS031	'KSYN'	722003,	371.754822	478.146027	7 10 !
! SS032	'KBWP'	722004,	100.999161	653.452332	7 10 !
! SS033	'KLYV'	722006,	134.958801	379.514679	7 10 !
! SS034	'KACQ'	722032,	333.878906	433.998291	7 10 !
! SS035	'KGDB'	722033,	181.560699	499.042145	7 10 !
! SS036	'KCFE'	722114,	307.498352	545.390259	7 10 !
! SS037	'KJKJ'	722129,	96.844124	715.808105	7 10 !
! SS038	'KMGG'	722144,	296.022736	553.863770	7 10 !
! SS039	'KOVL'	722168,	221.420837	503.003906	7 10 !
! SS040	'KRNH'	722179,	403.259186	550.473206	7 10 !
! SS041	'KRZN'	722183,	411.001251	621.797424	7 10 !
! SS042	'KSFY'	722204,	611.118896	241.281296	7 10 !
! SS043	'KLCG'	722241,	78.773186	234.543762	7 10 !
! SS044	'KCNB'	722252,	128.874329	495.268707	7 10 !
! SS045	'KTKC'	722342,	179.218750	446.241730	7 10 !
! SS046	'KRXC'	723758,	513.212524	594.974731	7 10 !
! SS047	'KAXA'	725457,	284.761230	327.492554	7 10 !
! SS048	'KCAV'	725458,	325.802399	294.237671	7 10 !
! SS049	'KMIW'	725461,	393.433167	232.077042	7 10 !
! SS050	'KCCY'	725463,	411.742310	333.622681	7 10 !
! SS051	'KGIN'	725468,	249.315628	218.213760	7 10 !
! SS052	'KDBQ'	725470,	562.008728	273.891357	7 10 !
! SS053	'KAMW'	725472,	339.960693	217.356750	7 10 !
! SS054	'KMXO'	725475,	529.074829	252.985184	7 10 !
! SS055	'KDEH'	725476,	476.241272	359.092377	7 10 !
! SS056	'KEBS'	725478,	318.428436	261.887787	7 10 !
! SS057	'KALO'	725480,	430.451233	280.485382	7 10 !
! SS058	'KLRJ'	725484,	139.213089	291.510315	7 10 !
! SS059	'KMCW'	725485,	355.652557	339.276703	7 10 !
! SS060	'KBNW'	725486,	322.820679	221.638809	7 10 !
! SS061	'KOLZ'	725488,	462.849091	295.942047	7 10 !
! SS062	'KORC'	725489,	148.912033	313.869507	7 10 !
! SS063	'KFOD'	725490,	284.697876	278.665985	7 10 !
! SS064	'KSHL'	725495,	164.999420	337.029449	7 10 !
! SS065	'KSLB'	725496,	212.618134	274.528046	7 10 !
! SS066	'KANW'	725556,	-152.562332	271.011780	7 10 !
! SS067	'KONL'	725566,	-52.690170	258.100037	7 10 !
! SS068	'KSUX'	725570,	125.017456	250.804749	7 10 !
! SS069	'KAIA'	725635,	-371.946045	225.001831	7 10 !
! SS070	'KCDR'	725636,	-390.018555	307.721893	7 10 !
! SS071	'KVTN'	725670,	-195.296432	301.377747	7 10 !

! SS072	'KTOR'	725763,	-476.574402	232.416214	7	10 !
! SS073	'KLNR'	726416,	594.580078	362.063934	7	10 !
! SS074	'KMDZ'	726417,	567.921021	557.987793	7	10 !
! SS075	'KOE0'	726418,	390.745178	566.480835	7	10 !
! SS076	'KASX'	726419,	510.271820	705.353516	7	10 !
! SS077	'KSUW'	726427,	424.747314	713.702942	7	10 !
! SS078	'KLSE'	726430,	508.635651	411.707031	7	10 !
! SS079	'KEAU'	726435,	482.727417	526.252747	7	10 !
! SS080	'KVOK'	726436,	581.265625	437.046356	7	10 !
! SS081	'KCMY'	726437,	546.142822	436.117981	7	10 !
! SS082	'KOV5'	726438,	557.368958	352.953308	7	10 !
! SS083	'KRST'	726440,	414.564484	420.806641	7	10 !
! SS084	'KPDC'	726444,	525.151245	335.964905	7	10 !
! SS085	'KAQP'	726466,	146.927185	547.887634	7	10 !
! SS086	'KRPD'	726467,	457.289001	582.535217	7	10 !
! SS087	'KPBH'	726468,	555.096680	620.769592	7	10 !
! SS088	'KEST'	726499,	246.954147	360.483246	7	10 !
! SS089	'KSPW'	726500,	213.177475	333.802368	7	10 !
! SS090	'KMRJ'	726507,	593.426697	327.873383	7	10 !
! SS091	'KHyr'	726508,	476.630768	647.714050	7	10 !
! SS092	'KFSD'	726510,	94.328735	374.210144	7	10 !
! SS093	'KCut'	726514,	-424.749512	403.337982	7	10 !
! SS094	'KBKX'	726515,	89.727325	450.046783	7	10 !
! SS095	'KPHP'	726516,	-270.501099	428.665131	7	10 !
! SS096	'KIEN'	726517,	-344.901764	324.377960	7	10 !
! SS097	'KICR'	726518,	-139.856018	355.472290	7	10 !
! SS098	'K8D3'	726519,	73.856110	592.815918	7	10 !
! SS099	'KYKN'	726525,	47.198750	304.747040	7	10 !
! SS100	'K9V9'	726530,	-99.478973	394.145111	7	10 !
! SS101	'KD07'	726539,	-297.153381	532.540222	7	10 !
! SS102	'KHON'	726540,	-17.115011	458.027527	7	10 !
! SS103	'KORB'	726544,	362.149048	849.423584	7	10 !
! SS104	'KMHE'	726545,	-2.867938	394.439606	7	10 !
! SS105	'KATY'	726546,	62.674583	515.427490	7	10 !
! SS106	'KGHW'	726547,	196.441757	592.791626	7	10 !
! SS107	'KRRT'	726548,	184.543518	938.973633	7	10 !
! SS108	'KCOM'	726549,	374.770538	829.738953	7	10 !
! SS109	'KSTC'	726550,	289.477570	585.952942	7	10 !
! SS110	'KMVE'	726553,	170.196106	521.343323	7	10 !
! SS111	'KJYG'	726554,	258.831940	421.393066	7	10 !
! SS112	'KBRD'	726555,	279.693115	675.731506	7	10 !
! SS113	'KRWF'	726556,	217.481979	478.586823	7	10 !
! SS114	'KAXN'	726557,	190.130997	617.650024	7	10 !
! SS115	'KCOQ'	726558,	395.496307	713.259888	7	10 !
! SS116	'KMML'	726559,	162.968735	466.842621	7	10 !
! SS117	'KFFM'	726560,	133.957138	658.783936	7	10 !
! SS118	'KADC'	726561,	202.232361	677.177307	7	10 !
! SS119	'KLVN'	726562,	355.831726	493.177429	7	10 !
! SS120	'KFBL'	726563,	351.367981	461.196899	7	10 !
! SS121	'KRGK'	726564,	410.713379	492.334595	7	10 !
! SS122	'KMOX'	726565,	149.050827	583.337769	7	10 !
! SS123	'KPQN'	726566,	127.867722	417.218353	7	10 !
! SS124	'KULM'	726567,	261.794373	456.355988	7	10 !
! SS125	'KOWA'	726568,	356.252655	440.308838	7	10 !
! SS126	'KHCD'	726569,	269.311188	513.197021	7	10 !
! SS127	'KMFI'	726574,	580.651794	510.377930	7	10 !
! SS128	'KMIC'	726575,	343.520233	538.094177	7	10 !
! SS129	'KILL'	726576,	215.343185	538.084961	7	10 !
! SS130	'KANE'	726577,	354.121063	547.264282	7	10 !
! SS131	'KLXL'	726578,	267.035187	627.336975	7	10 !
! SS132	'KFCM'	726579,	335.989746	513.490601	7	10 !
! SS133	'KMSP'	726580,	353.555969	519.771912	7	10 !
! SS134	'KLJF'	726583,	258.245758	542.910095	7	10 !
! SS135	'KSTP'	726584,	366.675781	525.429749	7	10 !
! SS136	'KMKT'	726585,	305.851746	448.014862	7	10 !
! SS137	'KFRM'	726586,	270.888275	386.311646	7	10 !
! SS138	'KOTG'	726587,	183.869949	384.251251	7	10 !
! SS139	'KONA'	726588,	472.697937	442.873871	7	10 !
! SS140	'KAEL'	726589,	350.012085	393.702515	7	10 !
! SS141	'KMJQ'	726593,	228.025085	385.108063	7	10 !
! SS142	'KTOB'	726596,	389.349762	431.199585	7	10 !
! SS143	'KSGS'	726603,	369.330719	517.929749	7	10 !
! SS144	'KRAP'	726620,	-379.573975	433.557648	7	10 !
! SS145	'KRCA'	726625,	-382.719269	444.108978	7	10 !

! SS146 = 'K2WX',	726627,	-406.119324	598.495300	7	10 !
! SS147 = 'KGDV',	726676,	-485.291168	764.848572	7	10 !
! SS148 = 'KROS',	726679,	369.271759	606.119019	7	10 !
! SS149 = 'KPNM',	726682,	321.927612	589.078491	7	10 !
! SS150 = 'KMBC',	726685,	-176.595627	581.943726	7	10 !
! SS151 = 'KPIR',	726686,	-170.840286	460.034729	7	10 !
! SS152 = 'KBHK',	726777,	-451.931519	680.796631	7	10 !
! SS153 = 'KTWM',	727444,	447.882660	753.196777	7	10 !
! SS154 = 'KIWD',	727445,	568.052795	708.005310	7	10 !
! SS155 = 'KMZH',	727449,	375.724762	682.198181	7	10 !
! SS156 = 'KDLH',	727450,	416.484497	729.449829	7	10 !
! SS157 = 'KCKN',	727452,	97.614517	821.203613	7	10 !
! SS158 = 'KPKD',	727453,	210.237167	725.100281	7	10 !
! SS159 = 'KCKC',	727454,	538.050964	843.562256	7	10 !
! SS160 = 'KHIB',	727455,	366.902435	783.460327	7	10 !
! SS161 = 'KDYT',	727456,	428.819427	717.451233	7	10 !
! SS162 = 'KDTL',	727457,	152.005173	715.434570	7	10 !
! SS163 = 'KGPZ',	727458,	322.304291	757.524109	7	10 !
! SS164 = 'KELO',	727459,	436.137146	833.787537	7	10 !
! SS165 = 'KDXK',	727466,	135.592072	522.303162	7	10 !
! SS166 = 'KFGN',	727467,	213.240936	979.714966	7	10 !
! SS167 = 'KFOZ',	727468,	307.224548	821.887573	7	10 !
! SS168 = 'KGNA',	727469,	540.576965	834.178345	7	10 !
! SS169 = 'KINL',	727470,	320.312805	905.074768	7	10 !
! SS170 = 'KCDD',	727473,	386.335419	877.262329	7	10 !
! SS171 = 'KEVM',	727474,	391.790405	788.879883	7	10 !
! SS172 = 'KJMR',	727475,	345.046997	624.486511	7	10 !
! SS173 = 'KBDE',	727476,	235.597336	918.279846	7	10 !
! SS174 = 'KROX',	727477,	160.620377	929.324951	7	10 !
! SS175 = 'KHCO',	727478,	74.069351	916.788330	7	10 !
! SS176 = 'KVWU',	727486,	244.470413	858.134155	7	10 !
! SS177 = 'KXVG',	727497,	272.035095	736.835632	7	10 !
! SS178 = 'KCBG',	727503,	348.076263	590.344666	7	10 !
! SS179 = 'KAIT',	727504,	312.392944	692.284912	7	10 !
! SS180 = 'KFSE',	727505,	158.197388	796.274719	7	10 !
! SS181 = 'KMMW',	727506,	218.269440	412.281738	7	10 !
! SS182 = 'KBBB',	727507,	172.873306	559.424866	7	10 !
! SS183 = 'KPWC',	727508,	260.166504	708.491943	7	10 !
! SS184 = 'KSAZ',	727514,	231.012894	671.240906	7	10 !
! SS185 = 'KVVV',	727515,	116.557121	555.432495	7	10 !
! SS186 = 'KGYL',	727517,	292.026825	503.395447	7	10 !
! SS187 = 'KFAR',	727530,	85.235794	724.666626	7	10 !
! SS188 = 'KETH',	727533,	107.109177	604.916931	7	10 !
! SS189 = 'KJMS',	727535,	-48.600674	724.799500	7	10 !
! SS190 = 'KBJI',	727550,	217.668808	789.249329	7	10 !
! SS191 = 'KTVF',	727555,	127.754288	845.218018	7	10 !
! SS192 = 'KBFW',	727556,	470.053284	775.894714	7	10 !
! SS193 = 'KAUM',	727566,	382.861328	393.856171	7	10 !
! SS194 = 'KDVL',	727573,	-63.301125	849.265076	7	10 !
! SS195 = 'KRRR',	727575,	42.193775	833.090881	7	10 !
! SS196 = 'KGFK',	727576,	58.054287	831.958191	7	10 !
! SS197 = 'KHEI',	727584,	-338.650360	637.574768	7	10 !
! SS198 = 'KBIS',	727640,	-197.468048	711.348206	7	10 !
! SS199 = 'KDIK',	727645,	-344.816040	720.144897	7	10 !
! SS200 = 'KISN',	727670,	-395.559692	870.364624	7	10 !
! SS201 = 'KMIB',	727675,	-234.574783	887.034424	7	10 !
! SS202 = 'KMOT',	727676,	-229.883179	868.627991	7	10 !
! SS203 = 'KN60',	727677,	-243.419296	806.407776	7	10 !
! SS204 = 'KSDY',	727687,	-437.134430	821.736145	7	10 !
! SS205 = 'DB21',	992130,	569.102051	789.578186	7	10 !
! SS206 = 'DISW',	994190,	518.981140	762.303711	7	10 !
! SS207 = 'GDMN',	997259,	541.324097	834.560608	7	10 !
! SS208 = 'DULM',	997269,	208.355286	712.645996	7	10 !
! SS209 = 'SLVM',	997737,	492.508667	779.533997	7	10 !
! SS210 = 'SXHW',	997738,	545.045349	710.175049	7	10 !
! SS211 = 'KABR',	14929,	-30.927084	569.527222	7	10 !
! SS212 = 'CXCA',	712910,	665.708	995.123	7	10 !
! SS213 = 'CWKK',	714680,	659.087	1054.620	7	10 !
! SS214 = 'CZTB',	716670,	605.270	905.768	7	10 !
! SS215 = 'CYQT',	717490,	606.384	905.880	7	10 !
! SS216 = 'CWEC',	717510,	620.303	907.286	7	10 !
! SS217 = 'KPCZ',	720343,	670.534	487.112	7	10 !
! SS218 = 'KBUU',	722059,	743.135	322.231	7	10 !
! SS219 = 'KFEP',	722082,	650.792	265.980	7	10 !

```

! SS220 ='KTKV', 722332, 600.874 599.685 7 10 !
! SS221 ='KLNL', 723123, 637.072 675.329 7 10 !
! SS222 ='KRFD', 725430, 687.861 264.429 7 10 !
! SS223 ='KARV', 726404, 602.749 648.160 7 10 !
! SS224 ='KMWC', 726405, 758.425 368.114 7 10 !
! SS225 ='KUES', 726409, 744.074 359.229 7 10 !
! SS226 ='KMSN', 726410, 658.688 360.685 7 10 !
! SS227 ='KETB', 726413, 748.375 399.775 7 10 !
! SS228 ='KEFT', 726414, 645.849 304.217 7 10 !
! SS229 ='KJVL', 726415, 687.411 308.790 7 10 !
! SS230 ='KSTE', 726426, 631.316 505.457 7 10 !
! SS231 ='KRRL', 726449, 611.236 572.272 7 10 !
! SS232 ='KGRB', 726450, 735.334 513.081 7 10 !
! SS233 ='KISW', 726452, 609.461 483.824 7 10 !
! SS234 ='KOSH', 726456, 708.916 454.486 7 10 !
! SS235 ='KATW', 726457, 708.810 483.186 7 10 !
! SS236 ='KAUW', 726463, 619.378 544.664 7 10 !
! SS237 ='KRYV', 726464, 705.542 368.458 7 10 !
! SS238 ='KCWA', 726465, 617.935 528.652 7 10 !
! SS239 ='KCLI', 726502, 688.915 518.593 7 10 !
! SS240 ='KDLL', 726503, 622.616 397.178 7 10 !
! SS241 ='KEGV', 726504, 635.279 651.763 7 10 !
! SS242 ='KFLD', 726506, 716.660 432.829 7 10 !
! SS243 ='KUNU', 726509, 704.428 395.344 7 10 !
! SS244 ='KAIG', 726626, 655.759 571.941 7 10 !
! SS245 ='KRHI', 727415, 624.144 618.968 7 10 !
! SS246 ='KIMT', 727437, 720.330 648.861 7 10 !
! SS247 ='KCMX', 727440, 676.490 786.555 7 10 !
! SS248 ='PILM', 994090, 674.212 897.149 7 10 !
! SS249 ='ROAM', 994130, 611.612 853.525 7 10 !
! SS250 ='PCLM', 997732, 673.459 796.578 7 10 !

```

```

1
Four character string for station name
(MUST START IN COLUMN 9)

```

```

2
Six digit integer for station ID

```

!END!

INPUT GROUP: 8 -- Upper air meteorological station parameters

UPPER AIR STATION VARIABLES
(One record per station -- 10 records in all)

	1	2				
	Name	ID	X coord. (km)	Y coord. (km)	Time zone	
! US1	'ABR'	14929	-30.853664	569.526855	7	!
! US2	'BIS'	24011	-197.624863	710.933411	7	!
! US3	'DVN'	94982	579.394958	191.740204	7	!
! US4	'GGW'	94008	-603.732971	887.948792	7	!
! US5	'GRB'	14898	734.982605	509.566772	7	!
! US6	'INL'	14918	321.891815	905.579956	7	!
! US7	'LBF'	24023	-210.715042	121.217461	7	!
! US8	'MPX'	94983	330.071899	512.976318	7	!
! US9	'OAX'	94980	127.800606	139.010620	7	!
! US0	'UNR'	94043	-391.126526	436.751404	7	!

```

1
Four character string for station name
(MUST START IN COLUMN 9)

```

```

2
Five digit integer for station ID

```

!END!

INPUT GROUP: 9 -- Precipitation station parameters

PRECIPITATION STATION VARIABLES
 (One record per station -- 267 records in all)
 (NOT INCLUDED IF NPSTA = 0)

1	2				
Name	Station Code	X coord. (km)	Y coord. (km)		
! PS1	'BVDI', 110583,	704.8387	272.3856	!	
! PS002	'FEEI', 113262,	647.5109	271.0132	!	
! PS003	'LNKI', 114879,	631.2090	247.9581	!	
! PS004	'MHYI', 115493,	751.1465	283.1947	!	
! PS005	'KRFD', 117382,	687.8933	264.1178	!	
! PS006	'AMSI', 130200,	327.6863	218.9460	!	
! PS007	'BLVI', 130608,	584.8422	261.4843	!	
! PS008	'BYRI', 130853,	217.6606	225.4780	!	
! PS009	'CASI', 131257,	539.0943	261.5334	!	
! PS010	'CCTI', 131363,	500.1082	248.3606	!	
! PS011	'CKPT', 131442,	188.7850	290.5321	!	
! PS012	'KDBQ', 132367,	562.0087	273.8914	!	
! PS013	'FSCI', 132977,	332.1617	351.2404	!	
! PS014	'HORI', 133944,	148.3817	226.7336	!	
! PS015	'HBTI', 133980,	289.6530	290.3780	!	
! PS016	'IDGI', 134038,	191.6283	252.6864	!	
! PS017	'IWAJ', 134142,	365.1421	272.9465	!	
! PS018	'MSHI', 135198,	393.2604	227.0463	!	
! PS019	'KMCW', 135235,	355.9792	338.8755	!	
! PS020	'MGGI', 135315,	520.6938	336.1376	!	
! PS021	'MOVI', 135823,	148.6746	262.4633	!	
! PS022	'OCHI', 136190,	187.3795	359.1556	!	
! PS023	'OGDI', 136209,	306.8351	219.8488	!	
! PS024	'REMI', 136975,	155.4437	295.9428	!	
! PS025	'RINI', 137058,	265.1759	349.3717	!	
! PS026	'RWCI', 137167,	259.9339	254.6663	!	
! PS027	'SANI', 137326,	385.8669	364.4076	!	
! PS028	'SHFI', 137572,	360.6382	314.8558	!	
! PS029	'SHRI', 137602,	413.0282	295.5028	!	
! PS030	'SIBI', 137664,	173.7475	363.5918	!	
! PS031	'SIXI', 137700,	140.9742	320.5928	!	
! PS032	'KSUX', 137708,	125.0175	250.8047	!	
! PS033	'K3SE', 137844,	217.3630	334.0425	!	
! PS034	'SPLI', 137855,	460.0540	350.6164	!	
! PS035	'STYI', 137985,	341.7265	236.1608	!	
! PS036	'SPTI', 138009,	495.9100	298.6285	!	
! PS037	'TREI', 138315,	427.3502	241.8837	!	
! PS038	'KALO', 138706,	430.4512	280.4854	!	
! PS039	'WEBI', 138806,	323.6514	265.5879	!	
! PS040	'ALBM', 200089,	684.2539	732.0740	!	
! PS041	'BRUM', 201088,	635.1568	715.0804	!	
! PS042	'IRNM', 204090,	722.8865	645.7775	!	
! PS043	'KENM', 204328,	657.2375	712.0861	!	
! PS044	'ONGM', 206215,	622.5252	747.8704	!	
! PS045	'STMM', 207812,	680.3516	669.5223	!	
! PS046	'WAKM', 208559,	581.8848	704.2177	!	
! PS047	'ALBM', 210075,	355.3395	386.1382	!	
! PS048	'KAXN', 210112,	190.1019	616.1816	!	
! PS049	'AXNM', 210116,	192.0553	619.1755	!	
! PS050	'AMBM', 210157,	288.7599	411.9700	!	
! PS051	'BGFM', 210746,	294.6127	864.8739	!	
! PS052	'BKKM', 210973,	102.1184	655.9871	!	
! PS053	'BUFM', 211107,	303.8945	548.1531	!	
! PS054	'CMBM', 211227,	357.2755	590.0135	!	
! PS055	'RLWM', 211250,	196.2616	904.4382	!	
! PS056	'CANM', 211263,	128.1724	493.1620	!	
! PS057	'DDGM', 212166,	384.4749	433.4247	!	
! PS058	'KDLH', 212248,	417.3215	728.7693	!	
! PS059	'ELYM', 212543,	432.4948	844.2844	!	
! PS060	'ELVM', 212645,	388.3740	792.2442	!	
! PS061	'FLDM', 212842,	367.2563	739.9268	!	
! PS062	'FSSM', 212916,	161.3947	793.3084	!	
! PS063	'FRZM', 212964,	164.9626	706.2097	!	
! PS064	'GOLM', 213202,	339.6924	530.6596	!	
! PS065	'GDPM', 213296,	584.3096	861.8482	!	
! PS066	'GTEM', 213311,	181.4707	504.9010	!	

! PS067	'GLLM'	213411,	263.0453	675.7494	!
! PS068	'GNFM'	213417,	498.9962	874.2490	!
! PS069	'HLSM'	213463,	82.9847	769.6907	!
! PS070	'HLYM'	213863,	404.9866	689.0575	!
! PS071	'HSNM'	213962,	269.0934	518.4244	!
! PS072	'KINL'	214026,	320.6607	905.0931	!
! PS073	'LCRM'	214418,	503.6740	423.0656	!
! PS074	'LKFM'	214453,	215.1507	390.1127	!
! PS075	'FEDM'	214652,	269.2213	763.7258	!
! PS076	'LESM'	214721,	305.6771	474.0750	!
! PS077	'LTFM'	214793,	265.6005	631.9966	!
! PS078	'LUVM'	214937,	135.9208	384.2386	!
! PS079	'MRSM'	215175,	307.8797	805.9199	!
! PS080	'KMSP'	215435,	353.5560	519.7719	!
! PS081	'NRFM'	215987,	360.9039	478.3724	!
! PS082	'ONMM'	216166,	314.9640	642.0206	!
! PS083	'ORWM'	216228,	132.1633	650.9859	!
! PS084	'PKGM'	216612,	314.5689	766.2769	!
! PS085	'RIAM'	216795,	210.4573	827.7108	!
! PS086	'RDWM'	216822,	401.1355	493.9360	!
! PS087	'KRST'	217004,	414.0315	420.8777	!
! PS088	'RUDM'	217184,	471.0624	414.2486	!
! PS089	'KSTC'	217294,	289.5603	585.7471	!
! PS090	'SDYM'	217460,	336.0036	719.4551	!
! PS091	'SHRM'	217602,	243.9724	383.5873	!
! PS092	'SPFM'	217907,	225.7181	447.4742	!
! PS093	'SPRM'	217917,	482.1662	394.8293	!
! PS094	'SPGM'	217941,	423.4222	399.2727	!
! PS095	'TLRM'	218235,	142.8105	889.9860	!
! PS096	'TOFM'	218280,	506.4730	812.3920	!
! PS097	'TCYM'	218323,	177.4506	445.1472	!
! PS098	'TWNM'	218411,	121.8223	756.6730	!
! PS099	'WALM'	218613,	448.5977	775.0430	!
! PS100	'WAKM'	218621,	244.9690	747.1674	!
! PS101	'WRRM'	218679,	186.0316	935.6436	!
! PS102	'WTSM'	218729,	163.5419	526.7195	!
! PS103	'WHRM'	218947,	104.7027	613.4695	!
! PS104	'WLLM'	219004,	220.1296	540.7602	!
! PS105	'WNBW'	219059,	280.0303	783.5529	!
! PS106	'KOTG'	219170,	182.9918	383.1815	!
! PS107	'ALZM'	240165,	-473.8755	541.4405	!
! PS108	'EKLM'	242689,	-476.9735	633.4473	!
! PS109	'GNDM'	243581,	-479.6689	761.5683	!
! PS110	'ISMM'	244442,	-490.4647	698.6182	!
! PS111	'PTWM'	246589,	-452.8222	937.0795	!
! PS112	'WSBM'	248777,	-419.1858	943.3163	!
! PS113	'AMEN'	250180,	-73.5246	233.7535	!
! PS114	'BSTN'	250580,	-118.4281	270.1134	!
! PS115	'CLEN'	251776,	60.8985	261.9291	!
! PS116	'CFTN'	252049,	40.3591	297.2858	!
! PS117	'HRRN'	253620,	-464.1168	293.2032	!
! PS118	'LYNN'	255040,	-35.0843	295.4801	!
! PS119	'PNDN'	256630,	100.2274	221.5656	!
! PS120	'PIRN'	256720,	37.0557	229.3818	!
! PS121	'ROYN'	257351,	-7.7141	248.3947	!
! PS122	'KVTN'	258760,	-195.1619	303.3590	!
! PS123	'WAYN'	259050,	72.8387	240.0117	!
! PS124	'WHIN'	259262,	-265.8226	222.7091	!
! PS125	'ADMN'	320022,	-8.3296	871.8898	!
! PS126	'AMBN'	320189,	-379.4584	954.1055	!
! PS127	'ALYN'	320382,	-100.2561	631.6342	!
! PS128	'BLDN'	320450,	-5.9390	735.8462	!
! PS129	'BFRN'	320492,	-180.9230	831.2956	!
! PS130	'KBIS'	320819,	-198.0849	712.3129	!
! PS131	'BOWN'	320995,	-392.1297	658.3008	!
! PS132	'CAON'	321288,	-82.5768	888.9763	!
! PS133	'CRNN'	321362,	-79.5731	785.9337	!
! PS134	'CVLN'	321435,	20.7365	927.9660	!
! PS135	'DAWN'	322018,	-125.4999	719.1512	!
! PS136	'KDIK'	322183,	-344.4455	720.3346	!
! PS137	'DCKN'	322188,	-344.9175	730.0309	!
! PS138	'KFAR'	322859,	85.2358	724.6666	!
! PS139	'GLNN'	323496,	-275.0014	718.2638	!
! PS140	'GRAN'	323594,	40.1860	881.1769	!

! PS141	'KGFK'	323616,	57.4969	831.3218	!
! PS142	'GRFN'	323621,	63.5791	829.1727	!
! PS143	'HFDN'	323926,	-13.2475	764.6330	!
! PS144	'HZTN'	324083,	-169.5298	683.5571	!
! PS145	'HETN'	324180,	-338.1250	636.4974	!
! PS146	'KJMS'	324413,	-47.9586	724.3745	!
! PS147	'LNGN'	324958,	-23.9686	917.3320	!
! PS148	'LDSN'	325078,	-100.3021	868.1802	!
! PS149	'MESN'	325479,	-208.9686	715.8164	!
! PS150	'MCGN'	325720,	-343.1684	909.5942	!
! PS151	'KMOT'	325988,	-229.3390	868.1865	!
! PS152	'MNON'	325993,	-231.3919	860.2588	!
! PS153	'MONN'	326105,	-42.0241	700.6135	!
! PS154	'MTTN'	326155,	-312.1531	673.7914	!
! PS155	'OAKN'	326620,	-6.4662	639.6499	!
! PS156	'PBAN'	326947,	52.6743	939.8636	!
! PS157	'RAUN'	327405,	-284.0016	823.9304	!
! PS158	'RDTN'	327530,	-309.6853	727.9753	!
! PS159	'RIVN'	327585,	-239.5621	788.9016	!
! PS160	'RTEN'	327655,	-125.2927	906.5640	!
! PS161	'SRLN'	327844,	-68.9054	936.9689	!
! PS162	'TWNN'	328792,	-167.2207	878.3873	!
! PS163	'TRON'	328812,	-420.1660	775.9999	!
! PS164	'TUTN'	328853,	-136.6915	765.0718	!
! PS165	'WTGN'	329219,	-259.4384	634.7834	!
! PS166	'KISN'	329425,	-395.3525	868.1364	!
! PS167	'WTON'	329455,	-199.0533	751.7303	!
! PS168	'KABR'	390020,	-30.3432	568.7914	!
! PS169	'BROS'	391076,	92.1705	451.9631	!
! PS170	'CACS'	391294,	-437.8077	594.8177	!
! PS171	'CPRS'	391452,	8.2556	489.8082	!
! PS172	'CWDS'	391972,	-290.4360	420.1009	!
! PS173	'EMTS'	392557,	-444.1663	359.8992	!
! PS174	'EGMS'	392565,	-447.2860	393.6244	!
! PS175	'FAIS'	392852,	-298.5418	531.3470	!
! PS176	'GTYS'	393302,	-164.0811	525.8958	!
! PS177	'HOWS'	394037,	35.7884	419.1016	!
! PS178	'KHON'	394127,	-16.6633	459.3860	!
! PS179	'INTS'	394184,	-297.4555	398.1286	!
! PS180	'ISAS'	394268,	-252.1393	568.5466	!
! PS181	'LNRS'	394651,	-271.9312	329.3606	!
! PS182	'LKSS'	394766,	-109.6760	425.3580	!
! PS183	'LEMS'	394864,	-302.8922	628.0018	!
! PS184	'MCIS'	395381,	-239.2239	614.5892	!
! PS185	'MNOS'	395481,	32.6538	337.9855	!
! PS186	'MVLS'	395544,	-269.8144	477.8271	!
! PS187	'MSSS'	395620,	-201.9105	348.2929	!
! PS188	'MURS'	395891,	-203.9713	409.3122	!
! PS189	'PIES'	396170,	-180.5313	466.4690	!
! PS190	'ONKS'	396282,	-108.4420	547.5420	!
! PS191	'ORLS'	396304,	-399.6830	367.4265	!
! PS192	'RAPS'	396427,	-411.5727	437.1682	!
! PS193	'PKSS'	396574,	-40.6760	320.5826	!
! PS194	'KPIR'	396597,	-170.8458	459.8257	!
! PS195	'PNVS'	396636,	-312.4171	483.0867	!
! PS196	'KRAP'	396937,	-379.5922	433.2443	!
! PS197	'K3DE'	397052,	-38.9352	508.4391	!
! PS198	'EROS'	397662,	103.6776	391.1785	!
! PS199	'FSDS'	397666,	96.1284	375.3860	!
! PS200	'KFSD'	397667,	94.3272	374.3146	!
! PS201	'SPES'	397882,	-437.6306	486.2325	!
! PS202	'STPS'	397992,	-112.4635	446.7385	!
! PS203	'STKS'	398007,	-33.0744	375.5005	!
! PS204	'VRMS'	398622,	82.8919	289.0081	!
! PS205	'KATY'	398932,	63.0713	512.7103	!
! PS206	'WNRS'	398980,	48.2724	568.4824	!
! PS207	'WNDS'	399347,	-414.0301	384.8526	!
! PS208	'AFTW'	470045,	685.2767	311.5101	!
! PS209	'ALMW'	470124,	454.5445	467.7898	!
! PS210	'ARLW'	470308,	658.3940	377.4543	!
! PS211	'AEFW'	470349,	506.3299	707.5601	!
! PS212	'BBCW'	470456,	588.1370	475.5576	!
! PS213	'BLKW'	470855,	534.3033	469.9684	!
! PS214	'BVLW'	470890,	622.5366	323.1918	!

! PS215	= 'CHMW'	, 471416,	649.4243	351.2666	!
! PS216	= 'CHIW'	, 471568,	738.9901	462.9800	!
! PS217	= 'CHFW'	, 471578,	487.9245	533.2549	!
! PS218	= 'CLIW'	, 471667,	700.7871	302.8314	!
! PS219	= 'CNTW'	, 471676,	687.5571	519.3958	!
! PS220	= 'CRIW'	, 471897,	720.0029	600.3361	!
! PS221	= 'CBCW'	, 471913,	578.7880	299.1148	!
! PS222	= 'EPLW'	, 472447,	611.8039	522.4976	!
! PS223	= 'FRSW'	, 472973,	613.6624	443.8912	!
! PS224	= 'GENW'	, 473038,	512.1511	392.7966	!
! PS225	= 'KGRB'	, 473269,	734.4010	509.3955	!
! PS226	= 'HARW'	, 473453,	727.3196	387.8478	!
! PS227	= 'HYRW'	, 473511,	472.1889	644.6486	!
! PS228	= 'THRW'	, 473636,	660.4031	627.8968	!
! PS229	= 'HORW'	, 473756,	709.3147	397.4457	!
! PS230	= 'KLSE'	, 474370,	507.8517	424.7510	!
! PS231	= 'KARX'	, 474373,	512.9490	419.4862	!
! PS232	= 'LADW'	, 474396,	507.2212	588.8231	!
! PS233	= 'LAFW'	, 474404,	556.4146	396.8088	!
! PS234	= 'LANW'	, 474546,	551.7680	318.1030	!
! PS235	= 'LUCW'	, 474894,	404.0576	595.1112	!
! PS236	= 'LYNW'	, 474937,	524.9281	356.1731	!
! PS237	= 'KMSN'	, 474961,	658.6881	360.6846	!
! PS238	= 'MFDW'	, 475120,	584.9993	510.2444	!
! PS239	= 'MEDW'	, 475255,	564.6284	560.8494	!
! PS240	= 'MENW'	, 475335,	449.3014	524.7825	!
! PS241	= 'MERW'	, 475352,	574.7755	670.8159	!
! PS242	= 'RRLW'	, 475364,	614.4525	569.6350	!
! PS243	= 'MNGW'	, 475524,	448.9307	653.5699	!
! PS244	= 'NRIW'	, 475948,	401.2504	547.0966	!
! PS245	= 'PKFW'	, 476398,	549.4885	643.9443	!
! PS246	= 'PHEW'	, 476518,	647.8389	667.1542	!
! PS247	= 'PORW'	, 476718,	647.9724	400.2571	!
! PS248	= 'PRNW'	, 476854,	564.8926	604.7028	!
! PS249	= 'LTKW'	, 476939,	615.9632	639.5358	!
! PS250	= 'RILW'	, 477132,	457.3847	582.2273	!
! PS251	= 'RRVW'	, 477140,	604.4020	607.5921	!
! PS252	= 'SPOW'	, 478027,	446.7621	624.3160	!
! PS253	= 'STMW'	, 478259,	492.2289	488.2560	!
! PS254	= 'KMKX'	, 478316,	720.9299	348.8920	!
! PS255	= 'TOMW'	, 478515,	563.0179	441.0115	!
! PS256	= 'TREW'	, 478589,	493.0102	436.1974	!
! PS257	= 'WLKW'	, 479176,	682.3917	577.6713	!
! PS258	= 'WLDW'	, 479218,	540.3058	516.7501	!
! PS259	= 'WTRW'	, 479304,	509.5294	628.9366	!
! PS260	= 'DLCW'	, 482725,	-527.8164	377.3655	!
! PS261	= 'LCKW'	, 485371,	-508.2396	336.7448	!
! PS262	= 'MCTW'	, 486395,	-518.7186	461.0498	!
! PS263	= 'MCKW'	, 486603,	-472.6974	370.2560	!
! PS264	= 'NCLW'	, 486660,	-467.9591	419.5807	!
! PS265	= 'OSGW'	, 486935,	-482.4476	433.2086	!
! PS266	= 'TORW'	, 488995,	-481.9526	234.3690	!
! PS267	= 'WLDW'	, 489615,	-537.7224	241.8340	!

1

Four character string for station name
(MUST START IN COLUMN 9)

2

Six digit station code composed of state
code (first 2 digits) and station ID (last
4 digits)

!END!

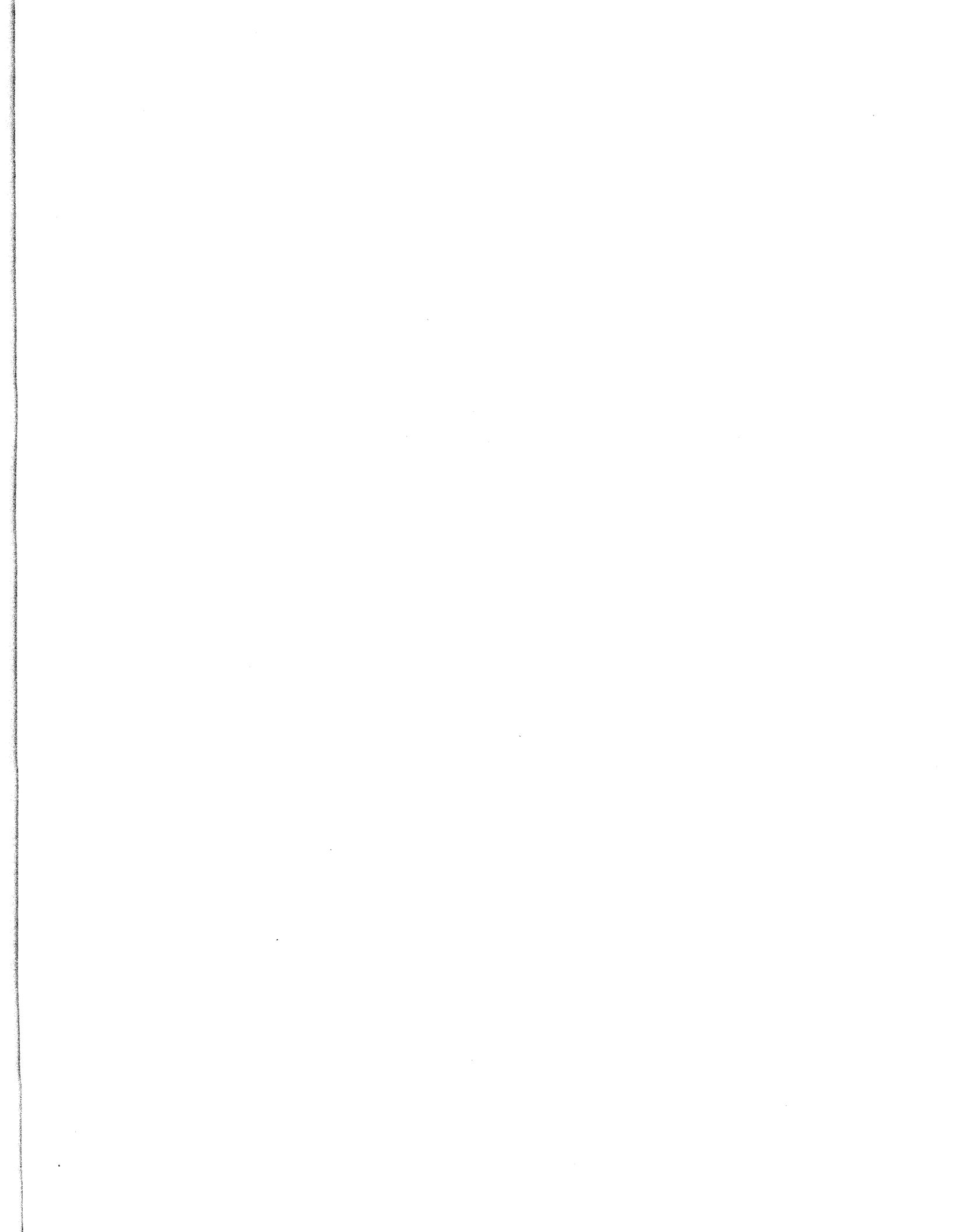

**Otter Tail Power Company
Big Stone Generating Station
Unit 1**

**Best Available Retrofit
Technology Analysis**

November 2, 2009

Project 53777



**Otter Tail Power Company
Big Stone Plant
Unit I
Best Available Retrofit Technology Analysis**

Table of Contents

LIST OF TABLES	iii
EXECUTIVE SUMMARY	ES-1
1.0 INTRODUCTION	1
1.1 BACKGROUND	2
1.2 BART ANALYSIS PARAMETERS.....	3
1.3 APPROACH	5
1.3.1 IDENTIFICATION OF RETROFIT CONTROL TECHNOLOGIES	6
1.3.2 FEASIBILITY ANALYSIS.....	6
1.3.3 EVALUATE TECHNICALLY FEASIBLE CONTROL OPTIONS BY EFFECTIVENESS.....	6
1.3.4 IMPACT ANALYSIS.....	6
1.3.5 METHODOLOGY FOR ESTIMATED COSTS.....	7
1.3.6 METHODOLOGY FOR VISIBILITY IMPACTS DETERMINATION	9
1.3.7 ADDITIONAL APPROACH METHODS	10
1.4 THE ROLE OF MODELING AND CALPUFF IN A BART ANALYSIS	10
1.4.1 CALPUFF MODELING METHODOLOGY.....	11
1.4.2 MODELING SCENARIOS	11
2.0 NO_x BART EVALUATION	13
2.0.1 BART GUIDELINE NO _x LIMITS FOR CYCLONE-FIRED BOILERS	13
2.1 IDENTIFICATION OF RETROFIT NO _x CONTROL TECHNOLOGIES ...	13
2.2 TECHNICAL DESCRIPTIONS AND FEASIBILITY ANALYSIS OF NO _x CONTROL TECHNOLOGIES	14
2.2.1 FEASIBILITY OF COMBUSTION NO _x CONTROLS.....	14
2.2.2 FEASIBILITY OF POST-COMBUSTION NO _x CONTROLS.....	15
2.2.3 RESULTS OF FEASIBILITY ANALYSIS	16
2.3 CONTROL EFFECTIVENESS EVALUATION OF NO _x CONTROL TECHNOLOGIES	16
2.4 EVALUATION OF IMPACTS FOR FEASIBLE NO _x CONTROLS.....	18
2.4.1 COST IMPACTS OF NO _x CONTROLS	18
2.4.2 ENERGY IMPACTS OF NO _x CONTROL ALTERNATIVES	25
2.4.3 NON AIR QUALITY AND OTHER ENVIRONMENTAL IMPACTS OF NO _x CONTROL ALTERNATIVES.....	27
2.4.4 VISIBILITY IMPAIRMENT IMPACTS OF NO _x CONTROLS	28
2.4.5 SUMMARY OF IMPACTS OF NO _x CONTROLS – BSP UNIT I	30
3.0 SO₂ BART EVALUATION	32
3.0.1 BART GUIDELINE SO ₂ LIMITS FOR CYCLONE-FIRED BOILERS	32

3.1	IDENTIFICATION OF RETROFIT SO ₂ CONTROL TECHNOLOGIES	32
3.2	TECHNICAL DESCRIPTION AND FEASIBILITY ANALYSIS	33
3.2.1	PRE-COMBUSTION FUEL TREATMENTS - FUEL SWITCHING	33
3.2.2	POST-COMBUSTION FLUE GAS DESULFURIZATION	33
3.2.3	RESULTS OF FEASIBILITY ANALYSIS	34
3.3	EVALUATE TECHNICALLY FEASIBLE SO ₂ CONTROL OPTIONS BY EFFECTIVENESS.....	35
3.4	EVALUATION OF IMPACTS FOR FEASIBLE SO ₂ CONTROLS	36
3.4.1	COST ESTIMATES	36
3.4.2	ENERGY IMPACTS	43
3.4.3	NON-AIR QUALITY ENVIRONMENTAL IMPACTS.....	43
3.4.4	VISIBILITY IMPACTS	44
3.4.5	IMPACT SUMMARY	45
4.0	PARTICULATE MATTER BART EVALUATION.....	46
4.1	IDENTIFICATION OF AVAILABLE RETROFIT PM CONTROL TECHNOLOGIES	46
4.2	TECHNICAL DESCRIPTION AND FEASIBILITY ANALYSIS	47
4.2.1	FABRIC FILTER (FF)	47
4.2.2	COHPAC	47
4.2.3	ELECTROSTATIC PRECIPITATOR (ESP).....	48
4.3	RANK OF TECHNICALLY FEASIBLE PM CONTROL OPTIONS BY EFFECTIVENESS.....	48
4.4	EVALUATION OF IMPACTS FOR FEASIBLE PM CONTROLS – UNIT 149	
4.4.1	VISIBILITY IMPACTS	49
5.0	BART RECOMMENDATIONS.....	49
5.1	NO _x BART	50
5.2	SO ₂ BART	50
5.3	PM BART	51
5.4	COMBINED BART.....	52

Appendix A

- Technical Feasibility Assessment Details for NO_x Controls (A1)
- Summary of CUECost Inputs (A2)
- Summary of Modeling Results (A3)

Appendix B

- Technical Description of SO₂ Controls (B1)

Appendix C

- Technical Description of Particulate Matter Controls (C1)

Appendix D

- Visibility Modeling and Impairment Improvement Analysis Details (D1)

List of Tables

- 1.2-1 – Unit Design and Operating Parameters
- 1.2-2 – Coal Parameters
- 1.2-3 – Economic Factors
- 1.4-1 – Big Stone Plant Modeling Scenarios

- 2.1-1 – Potentially Available NO_x Control Alternatives Identified for BART Analysis
- 2.2-1 – NO_x BART Feasibility Analysis Results
- 2.3-1 – Evaluated NO_x Control Technologies
- 2.3-2 – Estimated Control Options NO_x Emission Rates Evaluated
- 2.4-1 – Unit Capital Cost Factors of Feasible NO_x Control Options
- 2.4-2 – Estimated O&M Costs for NO_x Control Options
- 2.4-3 – Capital and Annualized Costs Estimated for NO_x Control Alternatives
- 2.4-4 – Estimated Annual Emissions and LTAC for NO_x Control Alternatives
- 2.4-5 – Estimated Incremental Annual Emissions and LTAC for NO_x Control Alternatives
- 2.4-6 – Visibility Impairment Impacts from Emission Controls
- 2.4-7 – Cost for Incremental Visibility Improvement
- 2.4-8 – Impacts Summary for BSP Unit I NO_x Controls

- 3.1-1 – SO₂ Control Technologies Identified for BART Analysis
- 3.2-1 – SO₂ BART Feasibility Analysis Results
- 3.3-1 – SO₂ Control Technologies Identified for BART Analysis
- 3.4-1 – First Year O&M Cost Estimate for BSP FGD Systems
- 3.4-2 – Capital and Annualized Costs Estimated for SO₂ Control Alternatives
- 3.4-3 – Estimated Annual Emissions and LTAC for SO₂ Control Alternatives
- 3.4-4 – Estimated Incremental Annual Emissions and LTAC for SO₂ Control Alternatives
- 3.4-5 – Energy Requirements of SO₂ BART Alternatives
- 3.4-6 – Visibility Impairment Impacts from Emission Controls
- 3.4-7 – Cost for Incremental Visibility Improvement
- 3.4-8 – Impacts Summary for BSP Unit I SO₂ Controls

- 4.1-1 – PM Control Technologies Identified for BART Analysis
- 4.2-1 – PM BART Feasibility Analysis Results

- 5.4-1 – Visibility Impairment Impacts from Combined Emissions

EXECUTIVE SUMMARY

The U.S. Environmental Protection Agency (EPA) finalized the Regional Haze Regulations and Guidelines for Best Available Retrofit Technology (BART) Determinations in 2005 (40 CFR 51, Subpart P; 40 CFR 51, App. Y). BART is defined as “an emission limitation based on the degree of reduction achievable through the application of the best system of continuous emission reduction for each pollutant which is emitted by a BART-eligible source. The emission limitation must be established, on a case-by-case basis, taking into consideration the technology available, the costs of compliance, the energy and non-air quality environmental impacts of compliance, any pollution control equipment in use at the source, the remaining useful life of the source, and the degree of improvement in visibility which may reasonably be anticipated to result from the use of such technology” (40 CFR 51.301). This document presents the BART analysis for each of three major pollutants (nitrogen oxides (NO_x), sulfur dioxide (SO₂), and particulate matter (PM)) for Otter Tail Power Company’s (OTPC’s) Big Stone Plant (BSP) Unit I located near Big Stone City, South Dakota. Otter Tail Power Company is operating agent for the Big Stone Plant co-owners: NorthWestern Energy, Montana-Dakota Utilities, Co., a division of MDU Resources Group, and Otter Tail Power Company.

BSP is a steam electric generating plant with one generating unit burning Powder River Basin coal and a net electrical output of 475 MW. Particulate control for Unit I is provided by a conventional pulse-jet fabric filter installed in 2007. Nitrogen oxides (NO_x) emissions from the unit are controlled with an over-fire air system (OFA). The unit does not have controls for sulfur dioxide emissions other than firing low-sulfur Powder River Basin coal. Unit I began operation in 1975 and is presumed to be subject to the requirements for BART analysis under the Regional Haze Rule absent a formal determination to the contrary from the DENR.

The BART analysis steps 1 through 5 for NO_x, SO₂ and PM emissions from BSP are described in this report. Potentially applicable control technologies are first identified. A brief description of the processes and their capabilities are then reviewed for availability and feasibility. Subsequently, those available technologies deemed feasible for retrofit application are ranked according to control capability. The impacts analysis then reviews the estimated capital and O&M costs for each alternative, the energy impacts and non-air quality impacts. The impact based on the remaining useful life of the source is reviewed as part of the cost analysis. In the final step of the analysis, feasible and available technologies are assessed for their potential visibility impairment impact reduction capability via visibility modeling results. The results of the impact analyses are tabulated and potential BART control options are listed.

The final result of this analysis is a recommendation of the Best Available Retrofit Technology (BART) based upon the detailed analysis conducted in this report. For NO_x, five control alternatives were identified and evaluated using the 5 steps. Over-fire air (OFA), separated over-fire air (SOFA), Selective Non-Catalytic Reduction (SNCR) with SOFA and Selective Catalytic Reduction (SCR) with SOFA were the technologies that remained after completing steps 1 through 4 of the analysis. To reduce visibility impacts due to NO_x emissions below a discernable level of 0.5 dV, SOFA is recommended as BART for BSP Unit I. Application of SOFA for NO_x control translates into a BART emission rate of 2,804 pounds per hour.

For SO₂, three control alternatives were identified and evaluated using the 5 steps. Wet FGD and semi-dry FGD at two levels of control were selected for visibility impacts evaluation after completing steps 1 through 4 of the analysis. To reduce visibility impacts due to SO₂ emissions below a discernable level of 0.5 dV, semi-dry FGD is recommended as BART for BSP Unit I. Application of semi-dry FGD for SO₂ control translates into a BART emission rate of 505 pounds per hour.

For the PM evaluation, three post combustion control technologies were selected for evaluation in addition to the existing pulse-jet fabric filter. BSP Unit I currently uses a pulse-jet fabric filter (installed in 2007) that is the best technology available for particulate control, the impact review was abbreviated and maintaining the existing pulse-jet fabric filter is recommended as BART for BSP Unit I. The corresponding BART emission rate for the existing fabric filter is 84.1 pounds per hour

Modeling to determine visibility impairment was performed using the recommended BSP Unit I BART emission rates for NO_x, SO₂, and PM. The 98th percentile results are provided in Table ES-1.

TABLE ES-1 – Visibility Impairment Impacts from Combined Emissions

Control Technique	NO_x Emission Rate (lb/hr)	SO₂ Emission Rate (lb/hr)	PM Emission Rate (lb/hr)	Visibility Impairment Impact (dV)
BART	2,804	505	84.1	0.493

The modeling showed that the proposed BART emissions rates for NO_x, SO₂ and PM caused no Class I area to exceed 0.5 dV for predicted visibility impairment impact (98th percentile) with Boundary Waters Canoe Area Wilderness (Boundary Waters) showing the highest predicted visibility impairment impact at 0.493 dV for the 2007 modeled year.

1.0 INTRODUCTION

The EPA finalized the Regional Haze Regulations and Guidelines for Best Available Retrofit Technology (BART) Determinations in 2005 (40 CFR 51, Subpart P; 40 CFR 51, App.Y). BART is defined as “an emission limitation based on the degree of reduction achievable through the application of the best system of continuous emission reduction for each pollutant which is emitted by a BART-eligible source. The emission limitation must be established, on a case-by-case basis, taking into consideration the technology available, the costs of compliance, the energy and non-air quality environmental impacts of compliance, any pollution control equipment in use at the source, the remaining useful life of the source, and the degree of improvement in visibility which may reasonably be anticipated to result from the use of such technology” (40 CFR 51.301). This document presents the BART analysis for each of three major pollutants (nitrogen oxides (NO_x), sulfur dioxide (SO₂), and particulate matter (PM)) for Otter Tail Power Company’s (OTPC’s) Big Stone Plant (BSP) Unit I located near Big Stone City, South Dakota. Otter Tail Power Company is operating agent for the Big Stone Plant co-owners: NorthWestern Energy, Montana-Dakota Utilities, Co., a division of MDU Resources Group, and Otter Tail Power Company.

A BART eligible source is one that meets three criteria identified by EPA: (1) source is BART eligible if operations fall within one of 26 specifically listed source categories, (2) the source entered into service between August 7, 1962 and August 7, 1977, and (3) the source has the potential to emit 250 tons per year or more of any air (40 CFR 51.301)). The South Dakota Department of Environment & Natural Resources (DENR) reviewed the sources within South Dakota and independently determined which sources are BART eligible. The DENR classified the electric generating unit (EGU) at Big Stone Plant as BART eligible. Once a source is determined to be eligible, baseline modeling is performed to determine if the source “contributes” to visibility impairment by exceeding EPA’s recommended 0.5 deciView (dV) threshold. Baseline modeling results show that Unit I at BSP exceeds the 0.5 dV impact threshold and is subject to a BART analysis.

The EPA has established guidelines for states to follow when determining BART. These guidelines are discretionary for sources other than 750 MW power plants (40 CFR 51.308(e); 40 CFR 51, App, Y, I.H). Per EPA’s guidelines, the general steps for determining BART for each pollutant are (40 CFR 51, Appy. Y, IV.D.):

STEP 1 - Identify all available retrofit control technologies (within the BART Guidelines).

STEP 2 - Eliminate technically infeasible options.

STEP 3 - Evaluate control effectiveness of remaining control technologies.

STEP 4 - Evaluate the following impacts for each feasible control technology and document results:

- The cost of compliance.
- The energy impacts.
- The non-air quality environmental impacts.
- The remaining useful life of the source.

STEP 5 – Evaluate the visibility impacts.

OTPC retained Burns & McDonnell to assist in the completion of the Best Available Retrofit Technology analysis for Big Stone Plant (BSP) Unit I.¹ This report includes steps 1 through 5 of the BART Determination for emissions from Unit I at BSP. Section 1 of the report summarizes the plant conditions, provides the parameters used in the analysis and discusses the approach to the BART Determination. The BART analysis for each pollutant (NO_x, SO₂ and PM) is provided in Sections 2 through 5. Within the section for each pollutant, the results of each step of the BART analysis are summarized for the unit. Summaries are provided at the end of the report that communicate the results of each step in the analyses, that combine results obtained for each pollutant and that develop permit limit recommendations based upon a 30 day rolling average.

1.1 BACKGROUND

Otter Tail Power Company operates the Big Stone Plant near Big Stone City, South Dakota. BSP is a steam electric generating plant with one Babcock & Wilcox (B&W) cyclone-fired steam generating unit burning Powder River Basin coal and a net electrical output of 475 MW. Particulate control for Unit I was originally provided by an electrostatic precipitator. In 2001, a new developmental technology, the Advanced Hybrid™ system, was installed. The Advanced Hybrid™ technology used both an electrostatic precipitator and a fabric filter (baghouse) for exhaust gas particulate removal. However, the demonstration technology encountered operational problems during its testing phase, which resulted in decreased fabric filter life, decreased particulate removal efficiencies, and limited plant operations. Consequently, the Advanced Hybrid™ system was deemed unacceptable for particulate emissions control and was removed and replaced with a conventional pulse-jet fabric filter in 2007. The Advanced Hybrid™ system is not currently used in any coal-fired power plant. Nitrogen oxides (NO_x) emissions

¹ Burns & McDonnell plans, designs and constructs electric generating facilities and has been providing environmental services to the power industry since the 1970s. As a result of its long history providing these services, Burns & McDonnell has extensive experience in permitting, Best Available Control Technology (BACT) studies, BART analysis and control technology analysis.

from the unit are controlled with an over-fire air system (OFA). The unit does not have controls for sulfur dioxide emissions other than firing low-sulfur Powder River Basin coal. Unit I began operation in 1975 and is presumed to be subject to the requirements for BART analysis under the Regional Haze Rule absent a formal determination to the contrary from the DENR.

1.2 BART ANALYSIS PARAMETERS

Table 1.2-1 contains the design and operating parameters for BSP Unit I used in the analysis. Typical coal parameters used in the BART analysis are provided in Table 1.2-2. The economic factors for this study are presented in Table 1.2-3.

TABLE 1.2-1 – Unit Design and Operating Parameters

Unit Characteristics	Unit I Parameters
Boiler Type	Cyclone
Boiler Manufacturer	B&W
Boiler Heat Input Capacity (descriptive), mmBtu/hr	5,609
Unit Generator Output Capacity, MW (net)	475
NO _x Emissions	
lb/mmBtu	0.86
lb/hr ¹	4,854.8
SO ₂ Emissions	
lb/mmBtu	0.86
lb/hr ¹	4,832.2
PM Emissions	
lb/mmBtu	0.015
lb/hr ²	84.1

¹Highest 24-hour actual average emission rates during 2001-2003 as recommended by the BART Guideline. The SO₂ emission rate does not correspond to fuel sulfur content.

²Highest achievable 24-hour average emission rate based on the existing control technology emission rate and the unit heat input

TABLE 1.2-2 – Coal Parameters

Ultimate Coal Analysis (% by mass):	PRB Typical
Moisture	29.75
Carbon	49.30
Hydrogen	3.32
Nitrogen	0.66
Chlorine	0.01
Sulfur	0.33
Ash	4.63
Oxygen	12.00
Total	100.00
Higher Heating Value, Btu/lb	8,547
Ash Mineral Analysis (% by mass):	
Silica	35.51
Alumina	17.11
Titania	1.26
Calcium Oxide	26.67
Magnesium Oxide	5.30
Sodium Oxide	1.68
Iron Oxide	6.07
Sulfur Trioxide	1.56
Potassium Oxide	2.87
Phosphorus Pentoxide	0.97
Strontium Oxide	not reported
Barium Oxide	not reported
Manganese Oxide	not reported
Total	99.00

TABLE 1.2-3 – Economic Factors

Total Possible Operating Hours per Year	8,760
Amortization Life, Years	30
Discount Rate	9%
Construction Cost Escalation	3%
O&M Escalation	2%
Auxiliary Electric Power Cost, \$/MW-hr	\$25
Fly Ash Disposal Cost (\$/ton)	\$2
Bottom Ash Disposal (\$/ton)	\$3.50
Gypsum Waste Disposal (\$/ton)	\$1
Operating Labor Rate, \$/hr	\$48
Lime Cost (\$/ton delivered)	\$145
Limestone Cost (\$/ton delivered)	\$24
Urea Cost, (\$/ton delivered)	\$380
Ammonia Cost (\$/ton delivered)	\$325

1.3 APPROACH

The purpose of the Regional Haze Rule is to address visibility impairment in mandatory Class I areas that results from the emission of SO₂, NO_x, PM, Volatile Organic Compounds (VOCs) and ammonia from certain major sources. The visibility impact of VOCs and ammonia are considered negligible and are not addressed further in this report. Before the actual BART analysis can begin, a basis must be defined for establishing emission rates to be used for BSP Unit I. For NO_x and SO₂, the highest 24-hour actual average emission rates for 2001-2003 were used for the basis as recommended by the BART guideline. For PM, the achievable emission rate for the fabric filter installed in 2007 was used as the basis of the study. A sulfuric acid mist (SAM) emission rate of 3.604 pounds per hour as approved in the Modeling Protocol was used for the baseline evaluation and for all control scenarios.

In Part IV of the Guidelines for BART Determination, and discussed in Section 1.0 of this report, the EPA provides five basic steps for a case-by-case BART analysis although states have the discretion to adopt approaches that differ from the guidelines for sources other than 750 MW power plants. The format of this report follows these basic steps. The approach used to complete each step is summarized below.

1.3.1 IDENTIFICATION OF RETROFIT CONTROL TECHNOLOGIES

The initial step in the BART determination is the identification of retrofit control technologies. In order to identify the applicable control technologies, several reference works are consulted. A preliminary list of control technologies and their estimated capabilities is developed.

1.3.2 FEASIBILITY ANALYSIS

The second step of the BART process is to evaluate the control processes that have been identified and determine if any of the processes are technically infeasible. The BART guidelines discuss consideration of two key concepts during this step in the analysis. The two concepts to consider are the “availability” and “applicability” of each control technology.

A control technology is considered available, “if the source owner may obtain it through commercial channels, or it is otherwise available in the common sense meaning of the term” or “if it has reached the stage of licensing and commercial availability.” On the contrary, a control technology is not considered available “in the pilot scale testing stages of development.” (70 FR 39165) When considering a source’s applicability, technical judgment must be exercised to determine “if it can reasonably be installed and operated on the source type.” The EPA also does not “expect a source owner to conduct extended trials to learn how to apply a technology on a totally new and dissimilar source type.” (70 FR 39165) “A technology that is available and applicable is technically feasible.” (70 FR 39165)

1.3.3 EVALUATE TECHNICALLY FEASIBLE CONTROL OPTIONS BY EFFECTIVENESS

The third step in the BART analysis is to evaluate the control effectiveness of the technically feasible alternatives. During the feasibility determination in step 2 of the BART analysis, the control efficiency is reviewed and presented with the description of each technology. The evaluation of the technically feasible BART alternatives concludes with the alternatives ranked in descending order of control effectiveness.

1.3.4 IMPACT ANALYSIS

Step four in the BART analysis procedure is the impact analysis. The BART Guidelines lists four factors to be considered in the impact analysis:

- The costs of compliance;
- Energy impacts;

- Non-air quality environmental impacts; and
- The remaining useful life of the source.

The first three of the four factors considered in the impact analysis are discussed in the associated pollutant section. The remaining useful life of the source is included as part of the cost of compliance. Due to the complexity involved with estimating costs, additional discussion is provided below.

1.3.5 METHODOLOGY FOR ESTIMATED COSTS

The economic evaluations of each control alternative are presented together for each pollutant in the respective sections of the report. Capital and O&M cost estimates for each control alternative are presented. The Levelized Total Annual Cost (LTAC) and Unit Control Costs for the control alternatives are calculated and presented. The Levelized Total Annual Cost (LTAC) represents the levelized annual cost of procurement, construction and operation over a 30 year design life in current (2009) dollars. As a minimum, the design life for any alternative was taken to be that recommended by “The EPA Air Pollution Control Cost Manual”, Sixth Edition, January 2002, EPA/452/B-02-001.

The LTAC is used to calculate the average annual and incremental cost effectiveness of each alternative. The differences between alternatives are also presented graphically in the form of a plot of the LTAC versus the annual emissions reduction (tpy) for each alternative. This form of plot graphically depicts the cost effectiveness (in \$/ton of pollutant reduction) of each alternative relative to all of the others. The average cost effectiveness is defined as the LTAC divided by the annual emissions reduction (ton/yr). The area on the plot indicated by the various data points represents the cost effectiveness envelope for the alternatives under consideration. A smooth line is drawn on this plot connecting the rightmost points (those with the lowest cost for a given level of emissions reduction). This line is referred to as the Dominant Control Curve (DCC). The DCC defines the right hand boundary of the envelope encompassing all of the alternatives considered. The DCC is used as a screening tool between considered alternatives. Those alternatives whose plotted position is above and/or to the left of the DCC are not as cost effective as those forming the line and thus can be eliminated from further analysis. An example DCC chart was provided in the BART Guidelines.

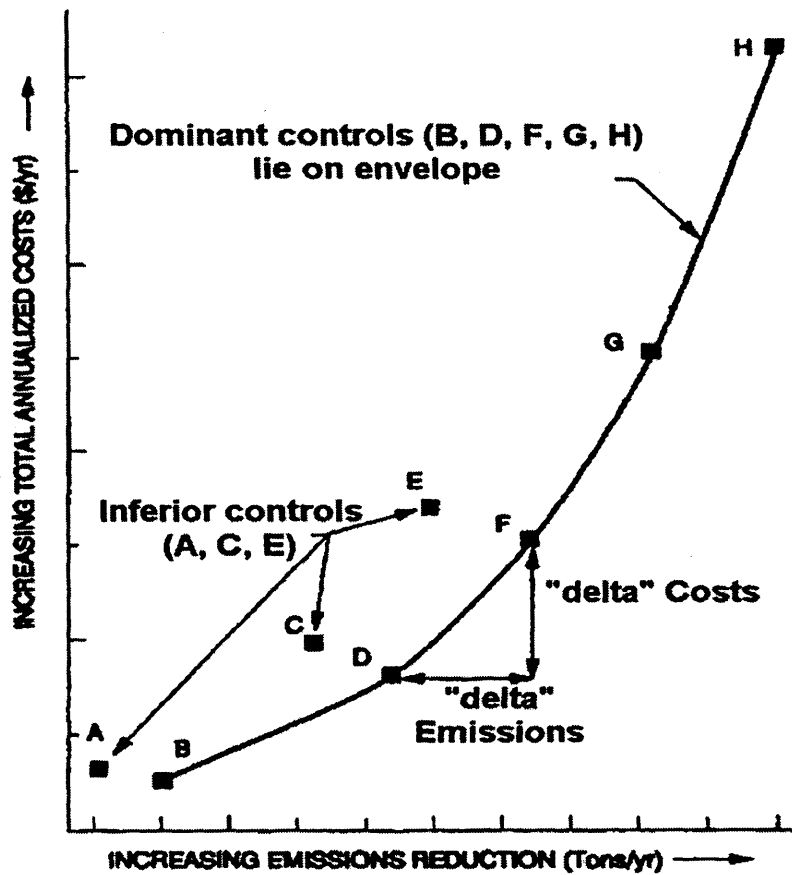

To more accurately compare alternatives having different costs and control efficiencies; the incremental cost effectiveness is also determined for those alternatives on the DCC. The incremental cost effectiveness is defined as the LTAC of a given control option minus the LTAC of an alternative, divided by the difference between the annual emissions reduction (tpy) of the given control option and the alternative being evaluated. The combination of these two economic analyses can be used as an argument for the elimination of control technologies with significantly greater marginal control costs than the given case. The equation used for the incremental cost effectiveness is shown below.

$$ICF = \frac{(LTAC_1 - LTAC_2)}{(AE_1 - AE_2)}$$

Where,

ICF = Incremental cost effectiveness (\$/incremental ton removed)
 LTAC₁ = Levelized Total Annual Cost of control alternative No. 1 (\$/yr)
 LTAC₂ = Levelized Total Annual Cost of control alternative No. 2 (\$/yr)
 AE₁ = Control option No. 1 Annual Emissions Reduction (ton/yr)
 AE₂ = Control option No. 2 Annual Emissions Reduction (ton/yr)
 (The higher cost, more effective control option is subscript 1 in this equation.)

The economic analyses presented in this report include not only the estimated capital and O&M costs for each alternative, but also the LTAC for economic comparison of the various alternatives. In addition, the average cost effectiveness is presented for each alternative. Finally, a comparison between alternatives, in the form of the incremental cost effectiveness, is presented in both numerical and graphical form. Thus a comprehensive comparison of the economic impacts of each alternative, as well as the differences in economic impact between alternatives is clearly presented.

1.3.6 METHODOLOGY FOR VISIBILITY IMPACTS DETERMINATION

In the BART Determination Guidelines, and discussed in Section 1.0 of this report, the EPA provides five basic steps for a case-by-case BART analysis. The fifth step involves evaluating visibility impacts utilizing dispersion modeling. Visibility impairment impacts for modeled baseline (pre-control) and post-control emission levels and visibility improvements are to be assessed in deciViews (dV). The BART guidelines describe the thresholds for visibility impairment as:

“A single source that is responsible for a 1.0 dV change or more should be considered to “cause” visibility impairment; a source that causes less than a 1.0 dV change may still contribute to visibility impairment..... any threshold that you (the States) use for determining whether a source “contributes” to visibility impairment should not be higher than 0.5 dV.” (70 FR 39161)

This study follows the EPA’s Regional Haze Rule threshold recommendations and thus, 0.5 dV is the de minimis threshold level of visibility impairment impact for an otherwise BART-eligible source. In other words, a BART-eligible source for which modeling predicts a visibility impairment impact of greater than 0.5 dV is deemed to contribute to a visibility impairment impact and thus is subject to a case-by-case BART analysis. A BART-eligible source for which the modeling predicts less than a 0.5 dV impact

would be deemed to not have a visibility impairment impact, and thus could be exempted from a case-by-case BART analysis on that basis. Most noticeably, the EPA fails to address the question of whether or not a difference in visibility impairment impact improvement of less than 0.5 dV between two BART alternatives would constitute equivalency under the visibility analysis, or if any difference in the model results, no matter how slight, should be interpreted as ranking one solution over the other.

The approach taken in the BART analysis for BSP incorporates the visibility analysis results as part of the decision making process. If two alternatives have an identical potential for visibility improvement, the remaining criteria identified for consideration as part of the impact analysis are then used to differentiate between the two alternatives. Where similar visibility improvement potentials are identified for two or more alternatives, the incremental cost to achieve the slightly greater visibility improvement is determined and evaluated against incremental costs for the next most stringent alternative. This approach identifies the more effective BART alternative in terms of regional haze considerations, not in terms of the most stringent control alternative, as would happen if a strictly top-down approach had been implemented.

1.3.7 ADDITIONAL APPROACH METHODS

In addition to the steps discussed above, the presumptive limits and their application to power plants smaller than 750 MW in size warrant mention due to their effects on the contents of the report. For power plants greater than 750 MW in size, the EPA requires state agencies to apply the presumptive limits for BART as a floor for NO_x or SO₂ control. However, for power plants smaller than 750 MW in size, the presumptive limits are described as being “generally cost-effective” but not set as a minimum performance requirement (see, e.g., 40 CFR 51, App. Y, IV.E.4). Thus, EGUs at power plants smaller than 750 MW in size, like BSP, are not required to meet the presumptive BART limits. This BART analysis for BSP will evaluate potential control options that can attain presumptive limits on typical EGUs. However, based upon the feasibility analysis, the recommended control options may not achieve the EPA’s presumptive BART limits for specific pollutants.

1.4 THE ROLE OF MODELING AND CALPUFF IN A BART ANALYSIS

The BART guidelines list visibility impact at a Class I area as one of the factors in a BART determination. For Class I areas more than 50 km from a source, the EPA has identified CALPUFF as a guideline model for long-range transport that is suitable for predicting potential changes in visibility.

CALPUFF is a non-steady-state meteorological and air quality dispersion modeling system used to assess long-range transport of pollutants. Seven Class I areas have been identified for inclusion in the visibility analysis for BSP. These are the Theodore Roosevelt National Park (NP), the Lostwood National Wildlife Refuge (WR), Voyagers NP, Isle Royal NP, Boundary Waters Canoe Area Wilderness, Badlands NP, and Wind Cave NP, the closest of which is more than 400 km (248 miles) from BSP.

1.4.1 CALPUFF MODELING METHODOLOGY

The specific version of CALPUFF, coordinate grid points, wind field options, terrain, dispersion options, receptor coordinates and plume characteristics and other model parameters approved by the DENR were used for modeling. Meteorological data for the years 2002, 2006 and 2007 were used for the modeling. In order to predict the change in light extinction at the Class I areas, SO₂, NO_x, and PM were modeled with CALPUFF using pre-control (baseline) and post-control emission scenarios. A variety of post-control scenarios were modeled to determine the reduction in visibility impact for each control technology.

The BART guideline states that a visibility improvement is based upon the modeled change in visibility impacts, measured in deciViews, for the pre-control and post-control emission scenarios. The comparison should be made for the 98th percentile days (40 CFR 51, App. Y, IV.D.5). In other words, visibility impacts should be compared on an annual basis using the eighth highest day for comparison ($365 * (1 - .98) \approx 7$ days of acceptable exceedance). Therefore, the visibility impairment impact reduction presented for each control scenario in this section is based on the 98th percentile value or eighth highest day.

1.4.2 MODELING SCENARIOS

Since a BART analysis is based on the degree of visibility impairment reduction achieved by the application of control technologies, the CALPUFF analysis examined multiple emission scenarios based upon the feasible control technologies identified for each pollutant. These scenarios represent the emissions of SO₂, NO_x, and PM under the following conditions:

- Baseline NO_x, SO₂ and PM emissions
- PM emissions based upon existing controlled baseline conditions, and NO_x and SO₂ emissions based upon application of several control technologies

The modeled emission rates in each scenario are presented in Table 1.4-1.

TABLE 1.4-1 – Big Stone Plant Modeling Scenarios

Scenario	Unit I		
	NO _x (lb/h)	SO ₂ (lb/h)	PM (lb/h) ¹
0 Baseline	4,854.8	4,832.2	84.1
1 Over-fire Air (OFA) Presumptive Dry FGD	3,645.9	841.4	84.1
2 OFA Presumptive Wet FGD	3,645.9	841.4	84.1
3 OFA Dry FGD at 90% Control	3,645.9	504.8	84.1
4 OFA Wet FGD at 95% Control	3,645.9	241.2	84.1
5 Separated OFA (SOFA) Presumptive Dry FGD	2,804.5	841.4	84.1
5A SOFA Dry FGD at 90% Control	2,804.5	504.8	84.1
5B SOFA Wet FGD at 95% Control	2,804.5	241.2	84.1
6 SNCR with SOFA Presumptive Dry FGD	1,963.2	841.4	84.1
7 RRI+SNCR with SOFA Presumptive Dry FGD	1,121.8	841.4	84.1
8 SCR with SOFA Presumptive Dry FGD	560.9	841.4	84.1

1 – The PM technology for all modeling scenarios is the existing pulse-jet fabric filter.

These scenarios represent the range of emissions evaluated for consideration in making a BART determination. The baseline scenario is based on the historical, highest 24-hour actual average SO₂ and NO_x emission rates for BSP between 2001 and 2003. The emission rate for PM is the achievable controlled emission rate for the existing fabric filter. Due to the number of variations involved for each pollutant, the scenarios are discussed in the section related to the controlled pollutant.

2.0 NO_x BART EVALUATION

The BART analysis steps 1 through 5 for NO_x emissions from BSP are described in this section. Potentially applicable NO_x control technologies are first identified. A brief description of the processes and their capabilities are then reviewed for availability and feasibility. A detailed technical description of each control technology is provided in Appendix A1. Subsequently, those available technologies deemed feasible for retrofit application are ranked according to nominal NO_x control capability. The impacts analysis then reviews the estimated capital and O&M costs for each alternative, including Balance Of Plant (BOP) requirements. Following the cost determination, the energy impacts and non-air quality impacts are reviewed for each technology. The impact based on the remaining useful life of the source is reviewed as part of the cost analysis. In the final step of the analysis, feasible and available technologies are assessed for their potential visibility impairment impact reduction capability via visibility modeling results. The results of the impact analyses are tabulated and potential BART control options are listed.

2.0.1 BART GUIDELINE NO_x LIMITS FOR CYCLONE-FIRED BOILERS

EPA's presumptive limit for emissions of nitrogen oxides from cyclone-fired boilers, which does not apply to BSP, was established in the final BART Guidelines¹:

“The use of SCRs at cyclone units burning bituminous coal, sub-bituminous coal, and lignite should enable the units to cost-effectively meet NO_x rates of 0.10 lbs/mmBtu. As a result, [the EPA] are establishing a presumptive NO_x limit of 0.10 lbs/mmBtu based on the use of SCR for coal-fired cyclone units greater than 200 MW located at 750 MW power plants.” [70 FR 39172]

40 CFR 51, App. Y, IV.E.5. While Unit I at BSP is greater than 200 MW output, it is not located at a 750 MW power plant. Thus, Unit I is not subject to presumptive limits.

2.1 IDENTIFICATION OF RETROFIT NO_x CONTROL TECHNOLOGIES

The first step in the BART evaluation for NO_x emissions is to identify potentially applicable retrofit control alternatives. A comprehensive literature search was performed, with sources including technical papers and presentations made by parties involved with design, construction, and testing of NO_x control techniques at conferences sponsored by nationally-recognized technical organizations, plus hardware supplier experience lists.

There are two basic categories of NO_x emission control alternatives:

- Combustion controls; and
- Post-Combustion controls.

A summary of the potentially available alternatives identified for NO_x emissions control on coal-fired cyclone units is shown in Table 2.1-1.

TABLE 2.1-1 – Potentially Available NO_x Control Alternatives Identified for BART Analysis

Combustion Controls
Low-NO _x Burners (LNBs)
Over-fire Air (OFA)
Separated Over-fire Air (SOFA)
Post-Combustion Controls
Selective Non-Catalytic Reduction (SNCR)
Rich Reagent Injection (RRI)
Selective Catalytic Reduction (SCR)

2.2 TECHNICAL DESCRIPTIONS AND FEASIBILITY ANALYSIS OF NO_x CONTROL TECHNOLOGIES

The second step of the BART process is to evaluate the control processes that have been identified and eliminate any that are technically infeasible for application at the source. The following paragraphs summarize the evaluation of the processes for technical feasibility for BSP Unit I NO_x controls. A detailed description of the various NO_x control technology retrofits and their technical feasibility is included in Appendix A1, with the associated references for technical literature.

2.2.1 FEASIBILITY OF COMBUSTION NO_x CONTROLS

The following combustion controls are potentially feasible technologies that are applied to a cyclone-fired boiler.

- An over-fire air (OFA) system has already been implemented on the Unit I boiler with the ability to significantly lower NO_x emissions. Implementation of more stringent operational procedures to

maintain significantly lower NO_x emissions with the existing OFA system was considered a feasible application at BSP for Unit I.

- Separated over-fire air (SOFA) systems have been retrofit to many cyclone boilers for combustion NO_x control.^{2,3,4,5,6} SOFA offers the highest performing version of this technology for cyclone boilers, and may include relocating vent ports and/or flue gas recirculation ports. SOFA is a feasible technology for BSP Unit I and is included in the control effectiveness analysis for additional NO_x. The NO_x control improvements through use of SOFA on Unit I will be limited by potential adverse impacts on cyclone operation associated with air-staged (sub-stoichiometric air/fuel) cyclone operation, which are described in Appendix A1.

Low-NOX burners (LNBs), while commonly applied to pulverized coal-fired boilers, are not applicable to cyclone fired units since initial combustion occurs in the barrel-shaped cyclone and not in the furnace chamber as is the case for the pulverized coal-fired boiler. Therefore, they will not be considered further.

2.2.2 FEASIBILITY OF POST-COMBUSTION NO_x CONTROLS

Post-combustion controls involve technologies that are applied to the flue gas after the combustion process. Typically these processes involve the use of a reagent to chemically react with NO_x. These are summarized as follows; for more details, refer to the technical feasibility evaluation included in Appendix A1:

- SNCR has been applied on several cyclone-fired boilers since 1995 and its installation on the Unit I cyclone boiler is considered feasible.^{7,8,9} Because BSP Unit I already has OFA for NO_x control, SNCR will be evaluated in conjunction with the existing OFA or SOFA.
- Rich Reagent Injection (RRI) injects aqueous urea into the high-temperature lower furnace zone and requires an “air-starved” atmosphere to avoid creating instead of reducing NO_x. RRI has been developed and demonstrated with application intended only on cyclone boilers.^{9,10,11,12} RRI has been installed and is commercially available.
 - RRI is susceptible to impairment due to fouling by ash slag deposits and heat-related damage of injection nozzles, which are located near the cyclones in the lower furnace.
 - RRI is considered feasible for application on cyclone boilers operating under substoichiometric conditions with advanced forms of SOFA and in combination with SNCR for NO_x control at BSP Unit I.
- Selective Catalytic Reduction (SCR) technology has been installed on 22 cyclone-fired boilers in the U.S., burning bituminous or sub-bituminous coals, and its installation on BSP Unit I for

additional NO_x control is considered technically feasible.³⁴ As with SNCR, SCR will be evaluated in conjunction with the existing OFA or SOFA.

2.2.3 RESULTS OF FEASIBILITY ANALYSIS

The results of the evaluation of the identified BART alternatives following the feasibility analysis are summarized in Table 2.2-1.

TABLE 2.2-1 – NO_x BART Feasibility Analysis Results

Control Technology	In service on Existing Utility Boilers	Commercially Available	Technically Applicable To Big Stone Plant
Over-fire Air (OFA)	Yes	Yes	Yes
Separated OFA (SOFA)	Yes	Yes	Yes
Selective Non-catalytic Reduction (SNCR) with OFA or SOFA	Yes	Yes	Yes
Rich Reagent Injection (RRI) + SNCR with SOFA	Yes	Yes	Yes
Selective Catalytic Reduction (SCR) with OFA or SOFA	Yes	Yes	Yes

2.3 CONTROL EFFECTIVENESS EVALUATION OF NO_x CONTROL TECHNOLOGIES

Control options that offer zero or very small additional control performance at a significant cost impact were not included in impact analysis. Alternatives that are equally effective in predicted emission reduction percentage but are more expensive to install and operate, or have more substantial operational limitations compared to other feasible alternatives, were also eliminated from further analysis. Table 2.3-1 lists the feasible control technologies and indicates the technologies evaluated in the analysis.

TABLE 2.3-1 – Evaluated NO_x Control Technologies

Control Technology	Approximate Control Efficiency	Evaluated
Over-fire Air (OFA)	25	Yes
Separated OFA (SOFA)	42	Yes
Selective Non-catalytic Reduction (SNCR) with OFA	60	No ¹
SNCR with SOFA	60	Yes
Rich Reagent Injection (RRI)+SNCR with SOFA	77	Yes
Selective Catalytic Reduction (SCR) with OFA	88	No ²
SCR with SOFA	88	Yes

1 – Due to an estimated \$1,810,000 increase in levelized annual costs for the same level of control as SNCR with SOFA, this technology would be above the dominant controls curve and are not evaluated further as described in Section 1.3.5.

2 – Due to an estimated \$140,000 increase in levelized annual costs for the same level of control as SCR with SOFA, this technology would be above the dominant controls curve and are not evaluated further as described in Section 1.3.5

Available NO_x emission control options considered feasible for BSP Unit I boiler are listed in Table 2.3-2 in descending order of control effectiveness. Ranking of the alternatives in Table 2.3-2 assumes that the baseline level of NO_x emissions for the BSP Unit I boiler is associated with the emission rate of 0.86 lb/mmBtu.

The emission reduction (control effectiveness) percentages developed for the feasible alternatives shown in Table 2.3-2 are estimates based upon engineering judgments with considerations of:

- the general combustion properties of Powder River Basin (PRB) coal;
- published and available emission reduction performance achieved at other similar utility power plants (wet-bottom cyclone-fired boilers); and
- inclusion of performance margins to allow for variations in fuel, weather, equipment condition, and other factors that prevent the ultimate peak short-term performance from being reliably sustained over the course of long-term operation.

The potential operational limitations mentioned in the detailed feasibility discussions included in Appendix A1 for deeply air-staged cyclones associated with separated over-fire air and Rich Reagent Injection alternatives are expected to limit the amount of NO_x control potential possible compared to other boiler types where this technique or technology was applied.

TABLE 2.3-2 – Estimated Control Options NO_x Emission Rates Evaluated

NO_x Control Technique	Emission Rate (lb/mmBtu)	Control Percentage	Hourly Emission (lb/hr)
SCR w/ SOFA	0.10	88	560.9
Rich Reagent Injection (RRI)+SNCR w/ SOFA	0.20	77	1,121.8
SNCR w/ SOFA	0.35	60	1,963.2
Separated Over-fire Air (SOFA)	0.50	42	2,804.5
Over-fire Air (OFA)	0.65	25	3,645.9
Baseline	0.86	--	4,854.8

2.4 EVALUATION OF IMPACTS FOR FEASIBLE NO_x CONTROLS

The fourth step of a BART analysis is to evaluate the following impacts of feasible emission controls:

- The cost of compliance.
- The energy impacts.
- The non-air quality environmental impacts.
- The remaining useful life of the source.

The purpose of the impacts evaluation is to determine if there are any energy, economic, non-air quality environmental reasons, or aspects of the remaining useful life of the source, which would eliminate the remaining control technologies from consideration for BSP Unit I.

2.4.1 COST IMPACTS OF NO_x CONTROLS

An evaluation was performed to determine the compliance costs of installing various feasible NO_x control alternatives on BSP Unit I boiler. This evaluation included estimates for:

- Capital costs;
- Fixed and variable operating and maintenance (O&M) costs; and
- Levelized total annual costs to engineer, procure, construct, install, startup, test, and place into commercial operation a particular control technology.

The results of this evaluation are summarized in Tables 2.4-1 through 2.4-6.

2.4.1.1 CAPITAL COST ESTIMATES FOR NO_x CONTROLS

The capital costs to implement the various NO_x control technologies were largely estimated from unit output capital cost factors (\$/kW) published in technical papers discussing those control technologies. Anticipated costs unique to BSP that are necessary for installation of the control technology were also identified. In the cases involving SNCR or RRI, vendor budgetary cost information was obtained and used in place of, or to adjust, the published unit output cost factors. These cost estimates were considered to be study grade, which is + or – 30% accuracy.

A review of the unit capital cost factor and associated capital costs for the feasible NO_x emission reduction technology evaluated for BSP are presented in Table 2.4-1.

TABLE 2.4-1 – Unit Capital Cost Factors of Feasible NO_x Control Options

NO _x Control Technique	Unit Capital Cost ¹ (\$/kW)	Capital Cost (\$1000)
SCR with SOFA	172 ²	81,800
RRI + SNCR with SOFA	34 ³	16,200
SNCR with SOFA	25	11,900
Separated Over-fire Air (SOFA)	10	4,800
Over-fire Air (OFA)	Existing	Existing

- 1 – Unit capital cost factors (\$/kW) of these individual technologies were combined by simple addition. Actual installed costs may differ due to positive or negative synergistic effects.
- 2 – Estimate taken from CUECost adjusted to reflect Burns & McDonnell project experience included in Appendix A2.
- 3 – RRI estimate is taken from the DOE report, “Field Testing of Advanced Layered Technology Approach (ALTA™) for NO_x Control in Sioux Unit 1”.

2.4.1.2 OPERATING AND MAINTENANCE COST ESTIMATES FOR NO_x CONTROLS

The operation and maintenance costs to implement the NO_x control technology evaluated for BSP Unit I were largely estimated from cost factors established in the EPA’s Air Pollution Control Cost Manual

(OAQPS), and from engineering judgment applied to that control technology. These cost estimates were considered to be study grade, which is + or – 30% accuracy.

Fixed and variable operating and maintenance costs considered and included in each NO_x control technology's O&M costs are estimates of:

- Auxiliary electrical power consumption for operating the additional control equipment;
- Reagent consumption, and reagent unit cost for SCR, SNCR and RRI alternatives;
- Catalyst replacement for SCR; and
- General operating labor, plus maintenance labor and materials devoted to the additional emission control equipment and its impact on existing boiler equipment.

A review of the estimated operation and maintenance costs for the feasible NO_x emission reduction technology evaluated for BSP are presented in Table 2.4-2.

TABLE 2.4-2 – Estimated O&M Costs for NO_x Control Options

NO _x Control Alternative	First Year O&M Cost (\$1,000)
SCR with SOFA	4,110
RRI+SNCR and SOFA	7,260
SNCR with SOFA	2,120
Separated Over-fire Air (SOFA)	152
Over-fire Air (OFA)	106

In order to compare a particular NO_x emission reduction alternative during the cost of compliance impact analysis portion of the BART selection process, the basic methodology defined in the BART Guidelines was followed. The Levelized Total Annual Cost (LTAC) of these NO_x control alternatives was calculated based on the same economic conditions and a 30 year project life (see Section 1.3.5 of this BART evaluation for methodology details). Estimated capital costs were split evenly over a two year construction period for all alternatives and a present value was calculated. Table 2.4-3 shows the estimated present value capital cost and annualized cost values for the various feasible NO_x emission reduction technologies. These are listed in order of control effectiveness, with the highest ranked options at the top.

TABLE 2.4-3 – Capital and Annualized Costs Estimated for NO_x Control Alternatives

NO_x Control Alternative	Capital Cost¹ (\$1000)	Present Value Capital Cost (\$1,000)	First Year O&M Cost (\$1,000)	Levelized Cost² (\$1,000)
SCR with SOFA	81,800	76,800	4,110	13,210
RRI+SNCR and SOFA	16,200	15,200	7,260	11,390
SNCR with SOFA	11,900	11,200	2,120	3,990
Separated Over-fire Air (SOFA)	4,800	4,500	152	650
Over-fire Air (OFA)	0	0	106	140

1 – Installed capital cost is estimated for determination of total capital cost for a control technology, assuming maximum unit output capacity is based on 475,000 kW.

2 – Levelized Total Annual Cost = Annualized Installed Capital Cost + Levelized Annual O&M cost.
The Annualized O&M cost factor = 1.361 and the Capital Recovery Factor = 0.0991

The average cost effectiveness was then determined as the LTAC divided by baseline annual tons of pollutant emissions that would be avoided by implementation of the respective alternative. Table 2.4-4 shows the average cost effectiveness comparison for the NO_x control technologies. The feasible control alternatives were also compared by calculating the change in LTAC per incremental ton of pollutant removed for the next most stringent alternative (incremental cost effectiveness). This identified which alternatives produced the highest increment of expected pollutant reduction for the estimated lowest average LTAC increment compared with the pre-control baseline emission rate. The expected annual number of tons of pollutant removed versus estimated LTAC for each remaining control alternative was then plotted.

TABLE 2.4-4 – Estimated Annual Emissions and LTAC for NO_x Control Alternatives

NO_x Control Alternative	Annual NO_x Emissions¹ (Tons/yr)	Annual NO_x Emissions Reduction¹ (Tons/yr)	Levelized Total Annual Cost (\$1,000)	Average Cost Effectiveness (\$/ton)
SCR with SOFA	2,090	16,000	13,210	825
RRI+SNCR and SOFA	4,180	13,910	11,390	818
SNCR with SOFA	7,310	10,780	3,990	197
Separated Over-fire Air (SOFA)	10,440	7,640	650	85
Over-fire Air (OFA)	13,570	4,510	140	31
Baseline	18,080	-	-	-

1 – Annual NO_x emissions and control level based upon 8,760 hours of operation and 85% capacity factor.

The comparison of the cost-effectiveness of the control options evaluated for BSP is shown in Figure 2.4-1. The estimated annual amount of NO_x removal (emission reduction) in tons per year is plotted on the abscissa (horizontal axis) and the estimated LTAC in thousands of U.S. dollars per year on the ordinate (vertical axis).

Figure 2.4-1 – NO_x Control Cost Effectiveness

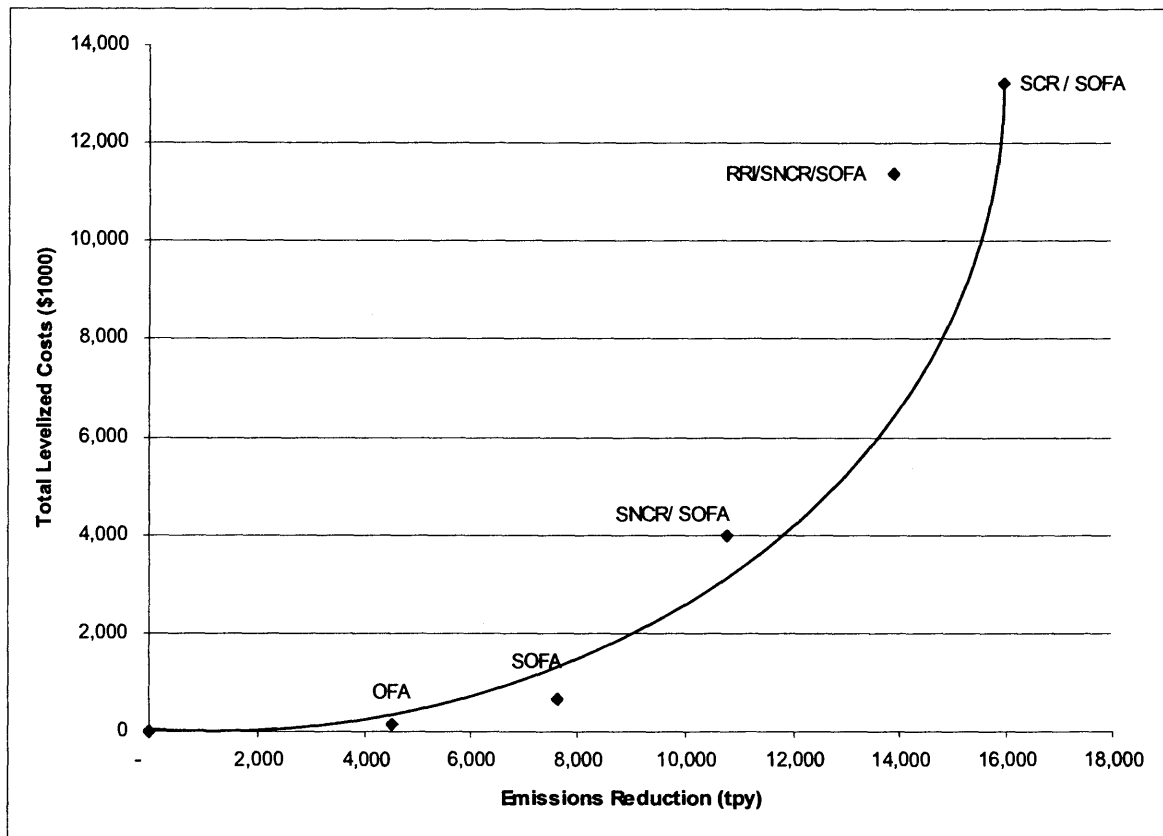

The purpose of Figure 2.4-1 is to show the range of control and cost for the evaluated NO_x reduction alternatives and identify the least-cost controls so that the Dominant Controls Curve (DCC) can be created. The DCC is the best fit line through the points forming the lower rightmost boundary of the data zone on a scatter plot of the LTAC versus the annual NO_x removal tonnage for the various remaining BART alternatives. Points distinctly to the left of and above this curve are inferior control alternatives per the BART Guidelines on a cost effectiveness basis. Following a “bottom-up” graphical comparison approach, each of the NO_x control technologies represented by a data point to the left of and above the least cost envelope should be excluded from further analysis on a cost efficiency basis. Of the highest-performing versions of the technically feasible NO_x control alternatives evaluated for cost-effectiveness, the data point for RRI/SNCR/SOFA is seen to be more costly for fewer tons of NO_x removed than for SCR with SOFA. This appears to be an inferior control, and thus should not be included on the least cost and DCC boundary. Figure 2.4.2 provides the DCC.

Figure 2.4-2 – NO_x Control Cost Effectiveness and Dominant Control Cost Curve

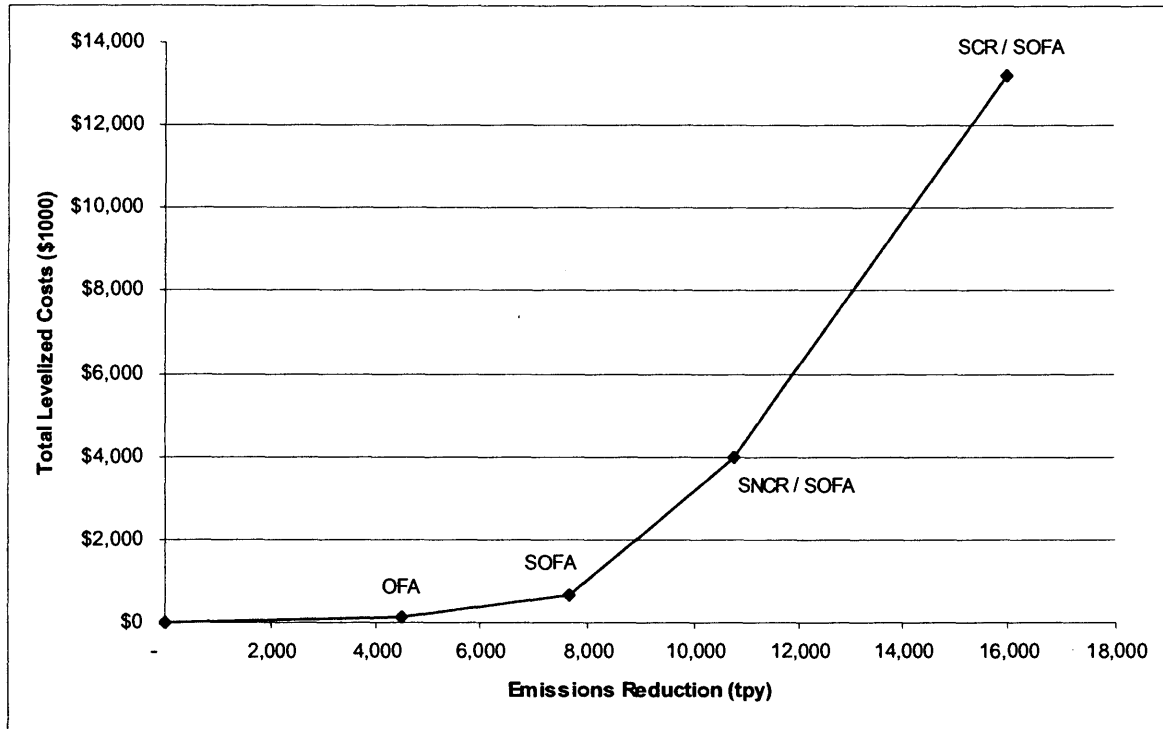

The next step in the cost effectiveness analysis for the BART NO_x control alternatives is to review the incremental cost effectiveness between remaining least-cost alternatives. Table 2.4-5 contains a repetition of the LTAC and NO_x control information with RRI+SNCR/SOFA removed, and shows the incremental cost effectiveness between each successive set of least-cost NO_x control alternatives. The incremental NO_x control tons per year, divided by the incremental levelized annual cost, yields an incremental control cost effectiveness (\$/ton).

**TABLE 2.4-5 – Estimated Incremental Annual Emissions and LTAC
for NO_x Control Alternatives**

NO_x Control Technique	Levelized Total Annual Cost (\$1,000)	Annual Emission Reduction¹ (Tons/yr)	Incremental Levelized Total Annual Cost² (\$1,000)	Incremental Annual Emission Reduction^{1,2} (Tons/yr)	Incremental Control Cost Effectiveness (\$/ton)³
SCR with SOFA	13,210	16,000	9,220	5,220	1,766
SNCR with SOFA	3,990	10,780	3,340	3,140	1,063
SOFA	650	7,640	510	3,130	163
OFA	140	4,510	140	4,510	31

1 – Annual NO_x emissions and control level based upon 8,760 hours of operation and 85% capacity factor.

2 – Increment based upon comparison between consecutive alternatives (points) from lowest to highest.

3 – Incremental control cost effectiveness is incremental LTAC divided by incremental annual emission reduction (tons per year).

In the final BART Guidelines, the EPA does not propose hard definitions for reasonable or unreasonable average or incremental cost effectiveness values. As can be seen from a review of Table 2.4-4, the average levelized control cost effectiveness of control alternatives ranges from \$31/ton to \$825/ton.

The incremental cost effectiveness is a measure of the increase in marginal cost effectiveness between two specific alternatives. The incremental cost analysis indicates that from a cost effectiveness viewpoint, the most costly alternative is SCR with SOFA. This control option is considered technically feasible for BSP, but incurs a significant annual (levelized) incremental cost compared to the other feasible NO_x control techniques.

2.4.2 ENERGY IMPACTS OF NO_x CONTROL ALTERNATIVES

The feasible NO_x control alternatives were reviewed for significant or unusual energy penalties or benefits associated with their use. There are several basic kinds of energy impacts for NO_x emissions controls:

- Potential increase or decrease in power plant energy consumption resulting from a change in thermal (heat) energy to net electrical output conversion efficiency of the unit, usually expressed as an hourly unit heat rate (Btu/kW-hr). This may or may not change the net electrical output

(MW) capacity of the EGU depending on if there are physical or imposed limits on the total heat input to the boiler or electrical power output.

- Potential increase or decrease in net electrical output of the unit resulting from changes in physical operational limitations imposed on the ability to sustain a fuel heat input rate (mmBtu/hr), which results in a potentially lower or higher unit net electrical output (MW) capacity. This is effectively a change in net electrical output (MW) capacity of the EGU.
- Potential increase or decrease in net electrical output of the unit resulting from changes in auxiliary electrical power demand and usage (kW, kW-hrs). This is effectively a change in net electrical output (MW) capacity of the EGU.
- Potential increase or decrease in reliability and availability to generate electrical power. This results in a change to the number of hours of annual operation, not necessarily a change in net electrical output (MW) capacity of the EGU.

There should not be a major impact on energy consumption by the operation of the variations of an over-fire air (OFA) system, such as separated over-fire air (SOFA). An OFA system does not significantly change the total amount of air introduced into the boiler, only the location where it is introduced.

Combustion air damper actuators' electrical power demand would be an insignificant (+ 1 kW) change in net electrical power consumption. For cyclone boilers, providing effective volumes and velocities of separated over-fire air at the injection ports should not require higher forced draft fan power consumption resulting from higher fan discharge pressure. Higher vent ductwork pressure drop impacts of the OFA system on the forced draft fans' auxiliary electrical power consumption are expected to be negligible (less than 1% of the annual auxiliary power consumed by these fans) so that unit net electrical output (MW) capacity is essentially the same as the current nameplate rating.

Boiler furnace exit gas temperature and superheater steam / reheater steam outlet temperatures may be slightly elevated during air-staged cyclone operation with OFA. This impact on the boiler's operation is typically small, and within the design capabilities of the boiler from a heat transfer and mechanical stress standpoint. This small negative impact (much less than 1%) on the plant unit heat rate (higher Btu/kW-hr) was not quantified, as the historical variation in coal heat content that influences plant unit heat rate is expected to have more significant impacts.

OFA is not expected to significantly reduce unit reliability and availability to generate electrical power, once the amount of secondary combustion air that can be withdrawn from the cyclones is established for consistent combustion and continuous slag tapping under substoichiometric air/fuel operating conditions.

There may be some changes in the degradation rate of the boiler's furnace waterwall tubes resulting from exposure of more area of the furnace walls to slightly air-starved conditions during OFA operation. Such conditions can promote corrosion from sulfur compounds in the furnace gases being created above the cyclones and below the OFA injection ports. Due to the relatively small amounts of sulfur content in the PRB coal and the modest amount of air-staging of the existing cyclones during OFA operation, the expected change in corrosion rate of the boiler tubes should be minor. This degradation is expected to occur over many years of operation, and normally requires periodic replacement of the deteriorated sections of boiler furnace waterwall tubes to avoid forced outages to repair tube leaks or failed sections. The potential change in the frequency of furnace wall tube failures and changeouts is difficult to estimate, and has not been quantified.

For SNCR-related NO_x control alternatives, the injection of a diluted urea solution requires some additional auxiliary power for heating and pumping the liquid, and using compressed air for atomization and cooling the reagent injection nozzles/lances, on the order of 150 to 400 kW. The injection of water (used for urea dilution) into the boiler flue gas also has a small negative impact on the plant heat rate (higher Btu/kw-hr), which is approximately equal to the heat released from the reaction of the reagent with NO_x or oxygen. The impact of additional flue gas created by operation of an SNCR-related system on induced draft fan power consumption should be insignificant.

For the SCR NO_x control alternative, the system requires the same 150 to 400 kW of auxiliary power for heating and pumping the reagent (ammonia) as SNCR, and using compressed air for atomization and cooling the reagent injection nozzles/lances, on the order of 150 to 400 kW. If a urea based reagent feed system is used, an additional 400 kW of auxiliary power is required to convert the urea to ammonia. However, the major consumer of auxiliary power for a SCR is additional induced draft fan power needed to overcome the additional 6 to 9 inches of water column pressure drop created by the addition of catalyst and ductwork. In most cases, the addition of an SCR would require replacement of the induced draft fans and depending upon the fan and motor efficiency additional 400 to 1000 kW of auxiliary power.

2.4.3 NON AIR QUALITY AND OTHER ENVIRONMENTAL IMPACTS OF NO_x CONTROL ALTERNATIVES

Operation using OFA or SOFA systems for NO_x emissions control will increase the amount of unburned carbon in the flyash produced by the boiler and collected for disposal by small increments. The potential

changes in the annual amounts of flyash disposal rates are expected to be inconsequential, and have not been quantified.

Operation of an SCR or SNCR system will normally create a small amount of unreacted ammonia or urea to be emitted into the flue gas. The amount of ammonia slip produced depends on the amount of reagent utilization and location of the injection points. Higher NO_x reduction performance involves greater amounts of reagent usage and ammonia slip. This is typically controlled to less than 10 ppmvd, especially since the possible formation of sulfates such as ammonium sulfate [(NH₄)₂SO₄] and ammonium bisulfate [NH₄HSO₄] will be more problematic at higher slip levels. Sulfur trioxide (SO₃) can also be formed during combustion in the boiler or conversion in the SCR to combine with ammonia during passage through the flue gas ductwork to form the sulfates.

Some of the unreacted ammonia and other compounds discussed above will be collected with the flyash in the pulse-jet fabric filter. If a scrubber is installed, some of the ammonia and other compounds will be captured. These collected materials may impact the disposal of fly ash or scrubber blow down.

Storage of ammonia reagent on-site creates the potential for accidents, leaks, and subsequent releases to air, ground, and surface water immediately surrounding the facility. Regulation of storage and containment of such reagents will be under the requirements of various federal Acts.

2.4.4 VISIBILITY IMPAIRMENT IMPACTS OF NO_x CONTROLS

The final impact analysis conducted was to assess the visibility impairment impact reduction for the NO_x control technologies. The analysis used a baseline NO_x emission rate which assumed the highest 24-hour actual emission rate for 2001-2003 as recommended by the BART guideline and listed in the Modeling Protocol. Four CALPUFF model runs for BSP were conducted with the constant SO₂ emission rate of 0.15 lb/mmBtu, constant PM emission rate of 0.015 lb/mmBtu, and various levels of NO_x control. Table 2.4-6 shows the modeled emission rates.

The difference between the modeled impacts at the 98th percentile level from various controlled emission rates represents the visibility impairment impact reduction in deciViews (dV). Table 2.4-6 shows the results of the visibility impact modeling attributable to NO_x reductions while maintaining PM and SO₂ emissions constant. A table containing the 98th percentile results for all modeled years and Class I areas is included in Appendix A3. Combined impacts from all pollutants are addressed later in the report.

TABLE 2.4-6 – Visibility Impairment Impacts from Emission Controls

NO_x Control Technique	Emission Rate (lb/mmBtu)	Visibility Impairment Impact (dV)	Visibility Impairment Reduction (Δ dV)¹	Technology Incremental Reduction (Δ dV)
SCR with SOFA	0.10	0.170	0.487	0.218
SNCR with SOFA	0.35	0.388	0.269	0.136
Separated Over-fire Air (SOFA)	0.50	0.524	0.133	0.133
Over-fire Air (OFA)	0.65	0.657	-	-
Baseline	0.86	1.079	-	-

1 – Impairment reduction is from OFA levels.

The results of the baseline visibility impairment modeling for BSP showed that NO_x emissions caused a Class I area to exceed 0.5 dV for predicted visibility impairment impact (98th percentile). Modeled visibility impairment impacts decreased with the addition of NO_x controls.

The 0.5 dV value is the lowest visibility impairment impact that is considered discernible by the human eye and the EPA set this threshold as the point where a given source is considered a “contributing source” (40 CFR 51, App. Y, III.A.1.). Thus, an impairment impact of less than 0.5 dV is considered visibly indiscernible. The difference in impacts between OFA (lowest control level) and SCR (highest control level) is less than 0.5 dV, which is visibly indiscernible. To assess the cost effectiveness of the various controls with respect to visibility improvement, the incremental cost to achieve the visibility improvement is determined and evaluated against incremental costs for the next most stringent alternative. Table 2.4-7 shows the costs to achieve the incremental reduction in visibility impairment.

TABLE 2.4-7 – Cost for Incremental Visibility Improvement

NO_x Control Technique	Incremental Levelized Total Annual Cost¹ (\$)	Impairment Reduction (Δ dV)	Incremental Reduction (Δ dV)	Cost for Incremental Improvement (\$/dV)
SCR with SOFA	9,220,000	0.487	0.218	42,290,000
SNCR with SOFA	3,340,000	0.269	0.136	24,560,000
Separated Over-fire Air (SOFA)	510,000	0.133	0.133	3,830,000
Over-fire Air (OFA)	140,000	-	-	-

1 – Increment based upon comparison between consecutive alternatives (points) from lowest to highest.

2.4.5 SUMMARY OF IMPACTS OF NO_x CONTROLS – BSP UNIT I

Table 2.4-8 summarizes the various quantifiable impacts discussed in Sections 2.4.1 through 2.4.4 for the NO_x alternatives evaluated for BSP Unit I.

TABLE 2.4-8 – Impacts Summary for BSP Unit I NO_x Controls

NO_x Control Technique	Emission Rate (lb/mmBtu)	Levelized Total Annual Cost (\$1,000)	Incremental Levelized Total Annual Cost¹ (\$1,000)	Visibility Impairment Impact (dV)	Visibility Impairment Reduction (dV)	Technology Incremental Reduction (Δ dV)
SCR with SOFA	0.10	13,210	9,220	0.170	0.487	0.218
SNCR with SOFA	0.35	3,990	3,140	0.388	0.269	0.136
Separated Over-fire Air (SOFA)	0.50	650	510	0.524	0.133	0.133
Over-fire Air (OFA)	0.65	140	140	0.657	-	-
Baseline	0.86	-	-	1.079	-	-

1 – Increment based upon comparison between consecutive alternatives (points) from lowest to highest.

NO_x SECTION REFERENCES:

1. "Regional Haze Regulations and Guidelines for Best Available Retrofit Technology (BART) Determinations"; Environmental Protection Agency; Federal Register, Volume 70, No. 128; July 6, 2005.
2. "The State of the Art in Cyclone Boiler NO_x Reduction", by O'Connor, Dave, Himes, Rick, and Facchiano, Tony (Electric Power Research Institute), presented at the EPRI-DOE-EPA Combined Utility Air Pollutant Control Symposium, Atlanta, GA, August 16-20, 1999.
3. "B&W's Advances on Cyclones NO_x Control Via Fuel and Air Staging Technologies", by Farzan, H., Maringo, G., Johnson, D. W., and Wong, D.K. (Babcock & Wilcox, Co.), Beard, C.T. (Eastman Kodak Company), and Brewster, S.E. (Tennessee Valley Authority), presented at the EPRI-DOE-EPA Combined Utility Air Pollutant Control Symposium, Atlanta, GA, August 16-20, 1999. Available at B&W's internet website: <http://www.babcock.com/pgg/tt/pdf/BR-1683.pdf>
4. B&W experience list September 18, 2002.
5. "Reburning Projects in the Department of Energy's Clean Coal Technology Demonstration Program", by Mann, Al and Ruppel, Tom (Parsons Corporation), and Sarkus, Tom (National Energy Technical Laboratory), presented at the 2004 DOE-NETL Conference on Reburning for NO_x Control, Morgantown, WV, May 18, 2004. A reburn-related document (an updated version of a poster from the May 18 Conference) is titled "Scorecard on Reburning 6/1/2004" by Al Mann and Tom Ruppel, Parsons Corporation, available on-line at: <http://www.netl.doe.gov/publications/proceedings/04/NOx/posters/Reburning%20Scorecard.pdf>
6. GE Energy (formerly GE-EER) experience list September 29, 2005.
7. "Demonstration of Rich Reagent Injection for NO_x Control in AmerenUE's Sioux Unit 1" by Cremer, Marc A. and Adams, Bradley R. (Reaction Engineering International), Boll, David E. (AmerenUE), and O'Connor, David C. (Electric Power Research Institute), presented at the US DOE Conference on SCR/SNCR for NO_x Control, Pittsburgh, PA, May 15-16, 2002.
8. "Evaluation of Cost Effective Non-SCR Options for NO_x Control in PRB Fired Cyclone Boilers" by Cremer, Marc A., Wang, David H. and Adams, Bradley R. (Reaction Engineering International); Boll, David E. and Stuckmeyer, Kenneth B. (AmerenUE), presented at the Western Fuels Symposium, 19th International Conference on Lignite, Brown, and Subbituminous Coals (formerly Low-Rank Fuels), October 12-14, 2004, Billings, MT.
9. "NO_x Emissions Below 0.15 lb/Mbtu Achieved in a Cyclone-Fired Boiler Using In-Furnace Control", by Cremer, M., Adams, B., and Chiodo, A., (Reaction Engineering International); Giesmann, C., Stuckmeyer, K., and Boyle, J. (AmerenUE), presented at the Powergen International 2005 conference, December 6-8, 2005, Las Vegas, Nevada.
10. RJM experience list September 3, 2004.
11. "Design and Demonstration of Rich Reagent Injections (RRI) Performance For NO_x Reduction at Connectiv's B.L. England Station" by Cremer, Marc A. and Adams, Bradley R. (Reaction Engineering International); O'Connor, David C. (Electric Power Research Institute); Bhamidipati, Venkata (Conectiv B.L. England Station), and Broderick, R. Gifford (RJM Corporation), presented at the 2001 US EPA/DOE/EPRI MEGA Symposium on SCR and SNCRs, Chicago, IL, August 20-23, 2001. (available from REI's internet website http://www.reaction-eng.com/downloads/rri_mega.pdf)
12. "Improved Rich Reagent Injection (RRI) Performance For NO_x Control In Coal Fired Utility Boilers" by Cremer, Marc A. and Wang, Huafeng D. (Reaction Engineering International), Boll, David E. (AmerenUE), Schindler, Edmund (RJM Corporation), and Vasquez, Edmundo RMT, Inc. (Alliant Energy Corp.), presented at 2003 U.S. DOE Conference on SCR and SNCR for NO_x Control, Pittsburgh, PA, October 29-30, 2003.

3.0 SO₂ BART EVALUATION

In this section, steps 1 through 5 of the BART determination for BSP are described for SO₂. Potentially applicable SO₂ control technologies are first identified. A brief description of the processes and their capabilities are then reviewed for availability and feasibility. A detailed technical description of each control technology is provided in Appendix B1. Subsequently, those available technologies deemed feasible for retrofit application are ranked according to nominal SO₂ control capability. The impacts analysis then reviews the estimated capital and O&M costs for each alternative, including Balance Of Plant (BOP) requirements. Following the cost determination, the energy impacts and non-air quality impacts are reviewed for each technology. The impact based on the remaining useful life of the source is reviewed as part of the cost analysis. In the final step of the analysis, feasible and available technologies are assessed for their potential visibility impairment impact reduction capability via visibility modeling results. The results of the impact analyses are tabulated and potential BART control options are listed.

3.0.1 BART GUIDELINE SO₂ LIMITS FOR CYCLONE-FIRED BOILERS

EPA's recommended limit for emissions of sulfur dioxides from cyclone-fired boilers was established in the final BART Guidelines:

“You [meaning States] must require 750 MW power plants to meet specific control levels for SO₂ of either 95 percent control or 0.15 lbs/mmBtu, for each EGU greater than 200 MW that is currently uncontrolled unless you determine that an alternative control level is justified based on a careful consideration of the statutory factors.”

40 CFR 51, App. Y, IV.E.4. While Unit I at BSP is greater than 200 MW output, it is not located at a 750 MW power plant. Thus, Unit I is not subject to presumptive limits.

3.1 IDENTIFICATION OF RETROFIT SO₂ CONTROL TECHNOLOGIES

The initial step in the BART determination is the identification of retrofit SO₂ control technologies. In order to identify the applicable SO₂ control technologies, several reference works were consulted, including “Controlling SO₂ Emissions: A Review of Technologies (EPA-600/R-00-093, October 2000) and the RACT/BACT/LAER Clearinghouse (RLBC). From these and other literature sources, a preliminary list of control technologies and their estimated capabilities was developed.

Removal of SO₂ from flue gas can either be accomplished prior to combustion, or post combustion. The primary method for pre-combustion controls is fuel switching. Post combustion methods include wet Flue Gas Desulfurization (FGD) typically using limestone reagent and semi-dry FGD technologies using lime reagent. Following are descriptions and technical analyses of the identified technologies for application to BSP Unit I. Table 3.1-1 contains the results of this effort.

TABLE 3.1-1 – SO₂ Control Technologies Identified for BART Analysis

Control Technology
Fuel Switching
Semi-Dry Flue Gas Desulfurization
Wet Flue Gas Desulfurization

3.2 TECHNICAL DESCRIPTION AND FEASIBILITY ANALYSIS

The second step in the BART analysis procedure is a technical feasibility analysis of the options identified in Step 1. The two concepts to consider are the “availability” and “applicability” of each control technology. The technical and feasibility analysis is presented below for each identified option.

3.2.1 PRE-COMBUSTION FUEL TREATMENTS - FUEL SWITCHING

Fuel switching can be a viable method of fuel sulfur content reduction in certain situations. The PRB coal listed in Table 1.2-2 is one of the lower sulfur coals available in the U.S. and switching to a different lower sulfur coal (if available) would achieve little to no additional reduction in SO₂ emissions. Therefore, for the purpose of this BART analysis, fuel switching is not considered a viable option for SO₂ control for BSP Unit I.

3.2.2 POST-COMBUSTION FLUE GAS DESULFURIZATION

Two different post combustion processes for reducing SO₂ emissions were evaluated as BART alternatives in this analysis. These include two well established Flue Gas Desulfurization (FGD) processes, wet and semi-dry. Commercially-available wet and semi-dry FGD processes achieve SO₂ removal by absorption of the SO₂ into an aqueous slurry which contains a neutralizing agent, normally either lime or ground limestone. Chemical reaction(s) between the SO₂ and the neutralizing agent convert the SO₂ to a stable compound that can be readily sold or disposed of in a permitted facility.

3.2.2.1 WET FLUE GAS DESULFURIZATION

Wet FGD technology utilizing lime or limestone as the reagent and employing forced oxidation to produce gypsum (calcium sulfate dihydrate, $\text{CaSO}_4 \cdot 2\text{H}_2\text{O}$) as the byproduct is commonly applied to coal-fired boilers. Absorbed SO_2 is converted to calcium sulfite and then oxidized to calcium sulfate dihydrate (gypsum) which is filtered from the scrubber solution and either disposed of in a permitted disposal facility, or possibly sold for wallboard production.

Based on commercial availability and applicability, wet FGD systems were found to be an acceptable BART alternative for SO_2 emission control.

3.2.2.2 SEMI-DRY FLUE GAS DESULFURIZATION

The most common semi-dry FGD system is the lime Spray Dryer Absorber (SDA) using a fabric filter for downstream particulate collection. This report addresses the spray dryer FGD process. Two other variations, the Novel Integrated Desulfurization (NID™) and Circulating Dry Scrubber are similar technologies that achieve similar levels of control effectiveness. They primarily differ by the type of reactor vessel used, the method in which water and lime are introduced into the reactor and the degree of solids recycling. Due to similar nature of the different semi-dry technologies and the similar levels of control efficiency achieved by all the technologies, semi-dry technologies are grouped together for the analysis. Technical characteristics associated with the semi-dry technologies are described in Appendix B1.

Based upon availability and applicability, semi-dry FGD is considered a viable alternative for SO_2 emission control.

3.2.3 RESULTS OF FEASIBILITY ANALYSIS

The results of the evaluation of the identified BART alternatives following the feasibility analysis are summarized in Table 3.2-1.

TABLE 3.2-1 – SO_2 BART Feasibility Analysis Results

Control Technology	In service on Existing Utility Boilers	Commercially Available	Technically Applicable To Big Stone Plant
Fuel Switching	Yes	Yes	No
Wet FGD	Yes	Yes	Yes
Semi-dry FGD	Yes	Yes	Yes

3.3 EVALUATE TECHNICALLY FEASIBLE SO₂ CONTROL OPTIONS BY EFFECTIVENESS

The third step in the BART analysis procedure is to evaluate the control effectiveness of the technically feasible alternatives.

Historically, wet FGD systems have operated with SO₂ control efficiency anywhere from 70% to in excess of 95%. For the purposes of this study, wet FGD performance was evaluated at presumptive BART limit of 0.15 lb/mmBtu and also at the 95% SO₂ control as representative of the performance of this technology on PRB coal. Further technical characteristics associated with wet FGD are described in Appendix B1.

No variation of semi-dry FGD systems has clearly demonstrated the ability to achieve SO₂ removal levels similar to wet FGD systems in the U.S. Table B-1, in Appendix B, lists many of the recent lime spray dryer system installations in the U.S. The information in Table B-1 was obtained from the RACT/BACT/LAER Clearing House. Burns & McDonnell completed a study of the emission reduction performance of existing, electric utility, semi-dry FGD systems.³ Information utilized for the evaluation was derived from EIA coal quality data and EPA SO₂ stack emissions and heat input data. The evaluation determined that the highest SO₂ removal efficiency maintained by semi-dry FGD on a continuous basis was just above 90%. No unit was able to maintain an efficiency of 95%. Semi-dry FGD is considered a viable alternative to achieve the presumptive SO₂ BART level, but the upper bound on SO₂ removal efficiency was set at 90% based on a review of the historic performance of this technology.

Table 3.3.1 presents the remaining BART alternatives following the feasibility analysis ranked in descending order according to their effectiveness in SO₂ control.

TABLE 3.3-1 – SO₂ Control Technologies Identified for BART Analysis

SO₂ Control Technique	Emission Rate (lb/mmBtu)	Control Percentage	Hourly Emission (lb/hr)
Wet Limestone FGD	0.043	95	241.2
Semi-dry Lime FGD	0.09	90	504.8
Presumptive Wet Limestone FGD	0.15	83	841.4
Presumptive Semi-dry Lime FGD	0.15	83	841.4
Baseline	0.86	--	4,832.2

3.4 EVALUATION OF IMPACTS FOR FEASIBLE SO₂ CONTROLS

Step four in the BART analysis procedure is the impact analysis. The BART Guidelines lists four factors to be considered in the impact analysis.

- The costs of compliance;
- Energy impacts;
- Non-air quality environmental impacts; and
- The remaining useful life of the source.

Three of the four impacts required by the BART Guidelines are discussed in the following sections. The remaining useful life of the source was determined to be greater than the project life definition in the EPA's OAQPS Control Cost Manual (EPA/453/B-96-001) and thus had no impact on the BART determination for BSP. In addition, the visibility impairment impact of each alternative was evaluated as part of the impact analysis.

3.4.1 COST ESTIMATES

Cost estimates for the wet and semi-dry (including SDA and fabric filter) SO₂ control technologies were completed utilizing the Coal Utility Environmental Cost (CUECost) computer model (Version 1.0) available from the EPA. The CUECost model is a spreadsheet-based computer model that was specifically developed to estimate the cost of air pollution control technologies for utility power plants within +/- 30 percent accuracy. The EPA released the version of the model used for this study in

February 2000. The model is available for download from the EPA website at <http://www.epa.gov/ttn/catcl/products.html>.

The user must specify the design parameters for the air pollution control technologies in CUECost. Unit costs for consumables, labor, and other variables can be modified by the user to fit the specific situation under evaluation. Because these models are in spreadsheet form, the calculation procedures and assumptions can be readily determined and adjusted by the experienced user as necessary to fit the unique requirements of the evaluation being conducted. The program itself is also somewhat user adjustable to compensate for local conditions. The CUECost default case is a generic facility located in Pennsylvania. Burns & McDonnell has adjusted the CUECost spreadsheets as described in the following sections to account for known facility and local conditions.

Operating information utilized as input into the model for the purpose of cost estimating is listed in Tables 1.2-1 and 1.2-2. Economic information utilized as input into the model is given in Table 1.2-3. The model was run with 2008 designated as the cost basis year because equipment cost estimating in the model is based on the Chemical Engineering Cost Index and the composite 2008 index is the latest version available. Following completion of the estimating on a 2008 cost basis year, all costs were escalated to a 2009 basis year utilizing the inflation rates designated in Table 1.2-3.

3.4.1.1 WET FGD CAPITAL COST ESTIMATE

The capital cost estimate for the wet FGD system includes the SO₂ control system and major support facilities. This capital cost estimate for wet FGD applies to either evaluated emission rate as the accuracy of the estimate cannot account for the cost differential due to minor equipment differences. The SO₂ control system cost is representative of a typical furnish and erect contract by a wet FGD system supplier. The "typical" furnish and erect contract would not include costs for foundations. The wet FGD system cost estimated by CUECost is broken down into the major subsystems of reagent preparation, SO₂ absorption tower, dewatering systems, flue gas handling systems (booster fans and ductwork) and support systems. The estimated capital cost associated with a wet FGD system is \$171,800,000 or a unit capital cost of \$362/kW.

3.4.1.2 SEMI-DRY FGD CAPITAL COST ESTIMATE

Estimated direct costs for the semi-dry FGD system include the absorbers and major support facilities. It was assumed that the existing fabric filter can be used to collect the reaction products from the semi-dry FGD absorber. The SO₂ control system cost is representative of a typical furnish and erect contract by a

lime semi-dry FGD system supplier. This capital cost estimate for semi-dry FGD applies to either evaluated emission rate as the accuracy of the estimate cannot account for the cost differential due to minor equipment differences. The “typical” furnish and erect contract would not include costs for foundations. The system costs estimated by CUECost are broken down into the major subsystems of reagent preparation, absorber, waste handling systems, flue gas handling systems (booster fans and ductwork) and support systems. The estimated capital cost associated with a semi-dry FGD system is \$141,300,000 or a unit capital cost of \$297/kW.

3.4.1.3 O&M COST ESTIMATE

The annual operating and maintenance costs (O&M) costs are comprised of fixed costs (maintenance and labor) and variable cost (consumables). These costs were developed as part of the CUECost model and include operating labor, administrative and support labor and maintenance. Table 3.4-1 summarizes the O&M cost estimates for the wet and semi-dry FGD systems.

TABLE 3.4-1 – First Year O&M Cost Estimate for BSP FGD Systems

SO ₂ Control System	Fixed Costs (\$1000/yr)	Variable Costs (\$1000/yr)	Total O&M (\$1000/yr)
Wet FGD	\$7,000	\$2,600	\$9,600
Presumptive Wet FGD	\$7,000	\$2,490	\$9,490
Semi-dry FGD	\$4,500	\$3,160	\$7,660
Presumptive Semi-dry FGD	\$4,490	\$2,990	\$7,480

3.4.1.4 LEVELIZED TOTAL ANNUAL COST

In order to compare a particular SO₂ emission reduction alternative during the cost of compliance impact analysis portion of the BART selection process, the basic methodology defined in the BART Guidelines was followed [70 FR 39167-39168]. The Levelized Total Annual Cost (LTAC) for these SO₂ control alternatives was calculated based on the same economic conditions and a 30 year project life (see Section 1.3.5 of this BART evaluation for methodology details). Estimated capital costs were split evenly over a two year construction period for all alternatives and a present value was calculated. Table 3.4-2 shows the estimated present value capital cost and the annualized cost for the two feasible SO₂ emission reduction technologies. These are listed in order of control effectiveness, with the highest ranked options at the top.

TABLE 3.4-2 – Capital and Annualized Costs Estimated for SO₂ Control Alternatives

SO ₂ Control Alternative	Capital Cost ¹ (\$1000)	Present Value Capital Cost (\$1,000)	First Year O&M Cost (\$1,000)	Levelized Cost ² (\$1,000)
Wet FGD	171,800	161,400	9,600	29,050
Presumptive Wet FGD	171,800	161,400	9,490	28,900
Semi-dry FGD	141,300	132,700	7,660	23,570
Presumptive Semi-dry FGD	141,300	132,700	7,480	23,330

1 – Installed capital cost is estimated for determination of total capital cost for a control technology, assuming maximum unit output capacity is based on 475,000 kW.

2 – Levelized Total Annual Cost = Annualized Installed Capital Cost + Levelized Annual O&M cost. The Annualized O&M cost factor = 1.361 and the Capital Recovery Factor = 0.0991

The average cost effectiveness was then determined as the LTAC divided by the annual tons of pollutant emissions that would be avoided by implementation of the respective alternative. Table 3.4-3 shows the average cost effectiveness comparison for the SO₂ control technologies. The feasible control alternatives were also compared by calculating the change in LTAC per incremental ton of pollutant removed for the next most stringent alternative (incremental cost effectiveness). This identified which alternatives produced the highest increment of expected pollutant reduction for the estimated lowest average LTAC increment compared with the pre-control baseline emission rate. The expected annual number of tons of pollutant removed versus estimated LTAC for each remaining control alternative was then plotted.

TABLE 3.4-3 – Estimated Annual Emissions and LTAC for SO₂ Control Alternatives

SO ₂ Control Alternative	Annual SO ₂ Emissions ¹ (Tons/yr)	Annual SO ₂ Emissions Reduction ¹ (Tons/yr)	Levelized Total Annual Cost (\$1,000)	Average Cost Effectiveness (\$/ton)
Wet FGD	900	17,100	29,050	1,699
Semi-dry FGD	1,880	16,120	23,570	1,462
Presumptive Wet FGD	3,130	14,870	28,900	1,944
Presumptive Semi-dry FGD	3,130	14,870	23,330	1,569
Baseline	18,000	-	-	-

1 – Annual SO₂ emissions and control level based upon 8,760 hours of operation and 85% capacity factor.

The comparison of the cost-effectiveness of the control options evaluated for BSP is shown in Figure 3.4-1. The estimated annual amount of SO₂ removal (emission reduction) in tons per year is plotted on the abscissa (horizontal axis) and the estimated levelized total annual cost in thousands of U.S. dollars per year on the ordinate (vertical axis).

Figure 3.4-1 – SO₂ Control Cost Effectiveness

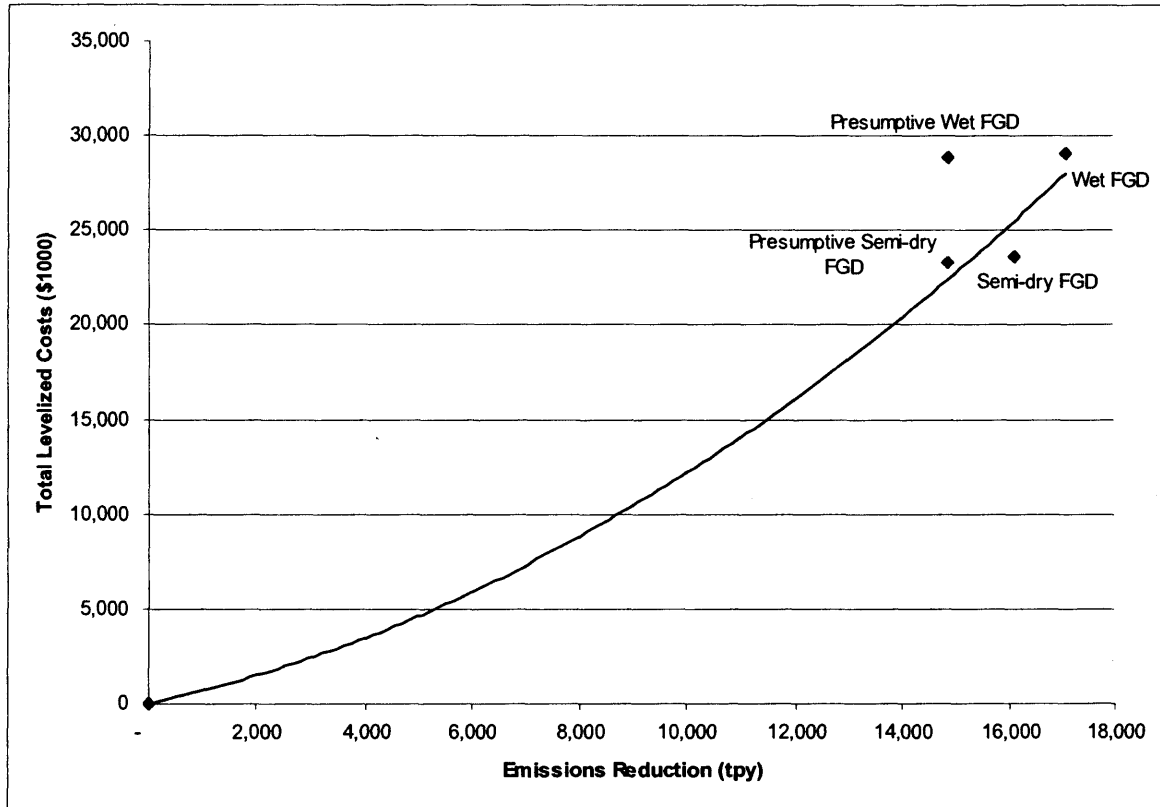

The purpose of Figure 3.4-1 is to show the range of control and cost for the evaluated SO₂ reduction alternatives and identify the least-cost controls so that the Dominant Controls Curve (DCC) can be created. The DCC is the best fit line through the points forming the lower rightmost boundary of the data zone on a scatter plot of the LTAC versus the annual SO₂ removal tonnage for the various remaining BART alternatives. Points distinctly to the left of and above this curve are inferior control alternatives per the BART Guidelines on a cost effectiveness basis. Following a “bottom-up” graphical comparison approach, each of the SO₂ control technologies represented by a data point to the left of and above the least cost envelope should be excluded from further analysis on a cost efficiency basis. Of the highest-performing versions of the technically feasible SO₂ control alternatives evaluated for cost-effectiveness, the data point for presumptive wet FGD is seen to be more costly for the same tons of SO₂ removed than for presumptive

semi-dry FGD, semi-dry FGD or wet FGD. The presumptive wet FGD appears to be an inferior control, and thus should not be included on the least cost and DCC boundary. Figure 3.4.2 provides the DCC for the SO₂ Controls

Figure 3.4-2 – SO₂ Control Cost Effectiveness and Dominant Cost Control Curve

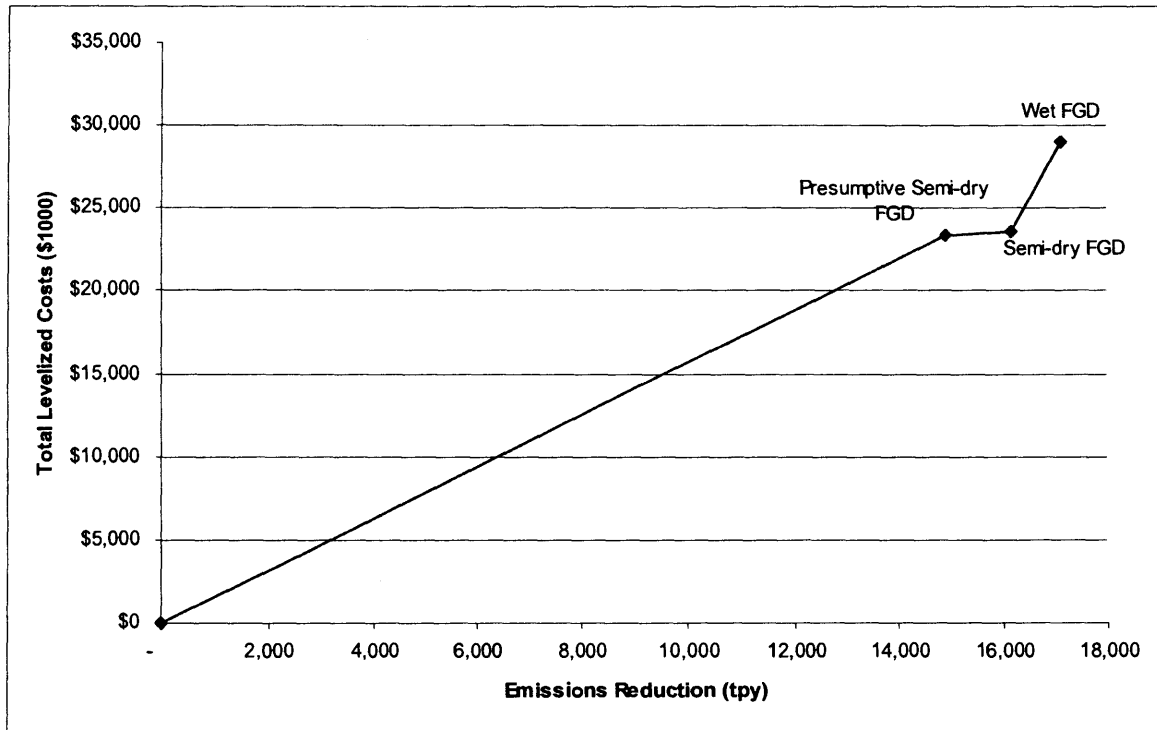

The next step in the cost effectiveness analysis for the BART SO₂ control alternatives is to review the incremental cost effectiveness between remaining least-cost alternatives. Table 3.4-4 contains a repetition of the levelized total annual cost and SO₂ control information with presumptive wet FGD removed, and shows the incremental cost effectiveness between each successive set of least-cost SO₂ control alternatives. The incremental SO₂ control tons per year, divided by the incremental levelized annual cost, yields an incremental average unit cost (\$/ton).

TABLE 3.4-4 – Estimated Incremental Annual Emissions and LTAC for SO₂ Control Alternatives

SO₂ Control Technique	Levelized Total Annual Cost (\$1,000)	Annual Emission Reduction¹ (Tons/yr)	Incremental Levelized Total Annual Cost² (\$1,000)	Incremental Annual Emission Reduction^{1,2} (Tons/yr)	Incremental Control Cost Effectiveness (\$/ton)³
Wet FGD	29,050	17,100	5,480	980	5,592
Semi-dry FGD	23,570	16,120	240	1,250	192
Presumptive Semi-dry FGD	23,330	14,870	23,330	14,870	1,569

1 – Annual SO₂ emissions and control level based upon 8,760 hours of operation and 85% capacity factor.

2 – Increment based upon comparison between consecutive alternatives from lowest to highest.

3 – Incremental control cost effectiveness is incremental LTAC divided by incremental annual emission reduction (tons per year).

As can be seen from a review of Table 3.4-4, the incremental levelized control cost effectiveness of control alternatives ranges from \$192/ton to \$5,592/ton. In the final BART Guidelines, the EPA state that:

“For example, you may be faced with a choice between two available control devices at a source, control A and control B, where control B achieves slightly greater emission reductions. The average cost (total annual cost/total annual emission reductions) for each may be deemed to be reasonable. However, the incremental cost (total annual cost A – B/total annual emission reductions A – B) of the additional control B may be very great. In such an instance, it may be inappropriate to choose control B, based on its high incremental costs, even though its average cost may be considered reasonable.” (40 CFR 51, App. Y, IV.D.e.5.)

The incremental cost effectiveness is a measure of the increase in marginal cost effectiveness between two specific alternatives. The incremental cost analysis indicates that from a cost effectiveness viewpoint, the most costly alternative is wet FGD. The wet FGD control option is considered technically feasible for BSP, but incurs a significant annual (levelized) incremental cost compared to the other feasible SO₂ control techniques and is an inappropriate control option based upon high incremental costs.

3.4.2 ENERGY IMPACTS

The energy impacts of each alternative, in terms of both estimated kW of energy usage and the percent of total generation, are given in Table 3.4-5. The primary energy impact of the wet FGD alternative consists of the additional electrical load resulting from pumps, blowers, booster fans, ball mills for limestone grinding and vacuum pumps for byproduct slurry dewatering. The largest energy users for the semi-dry alternatives are pumps, atomizers and booster fans. Building HVAC and interior and exterior lighting loads are also included, but the major energy consumption is due to the primary systems described above.

TABLE 3.4-5 Energy Requirements of SO₂ BART Alternatives

BART Alternative	Energy Demand (kW)	Percent of Nominal Generation
Wet FGD	9,500	2.0%
Semi-dry FGD	3,325	0.7%

3.4.3 NON-AIR QUALITY ENVIRONMENTAL IMPACTS

Non-air quality environmental impacts of the installation and operation of the various BART alternatives include solid and aqueous waste streams, and salable products that could result from the implementation of various BART alternatives. Captured mercury would be present in the solid waste stream from any post combustion alternative as a trace contaminant in the solid waste. Under current regulation, the presence of trace amounts of mercury would not affect its disposal.

A wet FGD system for BSP Unit I is estimated to produce approximately 6 tons per hour of solid waste. The waste stream would be composed of gypsum solids and inerts at approximately 15% moisture. Over the course of a year, the total solid waste quantity is estimated to be approximately 44,700 tons of gypsum solids which would need to be landfilled.

The annual quantity of aqueous waste that would be produced by a wet FGD system is difficult to quantify because the blowdown rate from a wet FGD system is primarily a function of the dissolved chloride levels in the absorber reaction tank. Most of the chloride reaching the scrubber is in the form of hydrochloric acid which is readily absorbed and neutralized. Based upon the use of relatively low chloride coal, one can assume the chlorides to be removed via the blowdown stream as CaCl₂ and would leave the plant in the entrained moisture in the solid waste. No blowdown specifically for chloride disposal or special treatment of the waste would be required under these conditions.

3.4.4 VISIBILITY IMPACTS

The final impact analysis conducted was to assess the visibility impairment impact reduction for the SO₂ control technologies. The analysis used a baseline SO₂ emission rate which assumed the highest 24-hour actual emission rate for 2001-2003 as recommended by the BART guideline and listed in the Modeling Protocol. Three CALPUFF model runs for BSP were conducted with the constant NO_x emission rate of 0.65 lb/mmBtu, constant PM emission rate of 0.015 lb/mmBtu, and various levels of SO₂ control applied. Table 3.4-6 shows the modeled emission rates.

The modeling for this analysis was performed using CALPUFF. The difference between the modeled impacts at the 98th percentile level from various controlled emission rates represents the visibility impairment impact reduction in deciViews (dV). Table 3.4-6 shows the results of the visibility impact modeling attributable to SO₂ reductions while maintaining NO_x and PM emissions constant. The modeling results with combined impacts from all pollutants are addressed later in the report.

TABLE 3.4-6 – Visibility Impairment Impacts from Emission Controls

SO ₂ Control Technique	Emission Rate (lb/mmBtu)	Visibility Impairment Impact (dV)	Visibility Impairment Reduction ¹ (Δ dV)	Technology Incremental Reduction (Δ dV)
Wet FGD	0.043	0.611	0.046	0.009
Semi-dry FGD	0.09	0.620	0.037	0.037
Presumptive Semi-dry FGD	0.15	0.657	-	-
Baseline	0.86	1.079	-	-

1 – Impairment reduction is from presumptive semi-dry FGD levels.

The results of the baseline visibility impairment modeling for BSP showed that SO₂ emissions caused a Class I area to exceed 0.5 dV for predicted visibility impairment impact (98th percentile). Modeled visibility impairment impacts decreased with the addition of all SO₂ controls.

As previously discussed, the 0.5 dV value is the lowest visibility impairment impact that is considered discernible by the human eye and the EPA set this threshold as the point where a given source is considered a “contributing source”. Thus, an impairment impact or a difference in impairment impacts of

less than 0.5 dV is considered visibly indiscernible. Because the difference in impacts between semi-dry FGD and wet FGD are 0.009 dV apart, the visibility improvement resulting from these controls is considered indiscernible. Where visibility improvement between alternatives is indiscernible, the incremental cost to achieve the indiscernible visibility improvement is determined and evaluated against incremental costs for the next most stringent alternative. Table 3.4-7 shows the costs to achieve the incremental reduction in visibility impairment.

TABLE 3.4-7 – Cost for Incremental Visibility Improvement

SO ₂ Control Technique	Incremental Levelized Total Annual Cost ¹ (\$)	Impairment Reduction (Δ dV)	Incremental Reduction (Δ dV)	Cost for Incremental Improvement (\$/dV)
Wet FGD	5,480,000	0.046	0.009	608,900,000
Semi-dry FGD	240,000	0.037	0.037	6,500,000
Presumptive Semi-dry FGD	23,330,000	-	-	-

1 – Increment based upon comparison between consecutive alternatives (points) from lowest to highest.

3.4.5 IMPACT SUMMARY

Table 3.4-8 summarizes the various quantifiable impacts discussed in Sections 3.4.1 through 3.4.4 for the SO₂ alternatives evaluated for BSP Unit I.

TABLE 3.4-8 – Impacts Summary for BSP Unit I SO₂ Controls

SO ₂ Control Technique	Emission Rate (lb/mmBtu)	Levelized Total Annual Cost (\$1,000)	Incremental Levelized Total Annual Cost ¹ (\$1,000)	Visibility Impairment Impact (dV)	Visibility Impairment Reduction (dV)	Technology Incremental Reduction (Δ dV)
Wet FGD	0.043	29,050	5,480	0.611	0.046	0.009
Semi-dry FGD	0.09	23,570	240	0.620	0.037	0.037
Presumptive Semi-dry FGD	0.15	23,330	23,330	0.657	-	-
Baseline	0.86	-	-	1.079	-	-

1 – Increment based upon comparison between consecutive alternatives (points) from lowest to highest.

4.0 PARTICULATE MATTER BART EVALUATION

In this section, steps 1 through 5 of the BART determination for BSP Unit I are described for PM. All PM control technologies are first identified. A technical description of the processes and their capabilities are then reviewed to determine availability and feasibility. Subsequently, those available technologies deemed feasible for retrofit application are ranked according to nominal PM control capability. The impacts analysis then reviews the estimated cost, energy, and non-air quality impacts for each technology. The impact of the remaining useful life of the source is reviewed as part of the cost analysis. In the final step of the analysis, the remaining technologies are assessed for their potential visibility impairment impact reduction capability via visibility modeling results. The results of the complete analyses are tabulated and possible BART control options are listed.

The BART guidelines published in the Federal Register on July 6, 2005 (70 FR 39104) do not specify presumptive BART levels for particulate matter (PM) emissions. The guidelines suggest the use of PM₁₀ as the indicator for all PM_{2.5}, because all PM_{2.5} is encompassed within the PM₁₀ emissions fraction. (40 CFR 51, App. Y, II.A.3.) The BART guidelines specify the distinction between coarse (PM₁₀ minus PM_{2.5}) or fine (PM_{2.5}) PM in determining visibility impacts, which was made during the CALPUFF visibility modeling.

The BART Guidelines indicate that one of the evaluated emission limits must be at least as stringent as the New Source Performance Standard (NSPS) requirement for the source (40 CFR 51, App. Y, IV.D.1). The BSP pulse-jet fabric filter meets the current NSPS emission rate 0.015 lb/mmBtu as required of new sources under 40 CFR § 60.42Da(c). All of the evaluated control technologies used a PM emission rate of 0.015 lb/mmBtu.

4.1 IDENTIFICATION OF AVAILABLE RETROFIT PM CONTROL TECHNOLOGIES

The initial step of the BART determination is the identification of available retrofit PM control technologies. In order to produce a list of control technologies and their estimated capabilities, sources such as the RACT/BACT/LAER Clearinghouse (RBLC) were used. The results of the investigation determined that the removal of PM from flue gas is accomplished using post combustion technology. The two most common post combustion technologies used to control PM emissions include fabric filters (FF)

and electrostatic precipitators (ESPs). The existing BSP configuration contains a pulse-jet fabric filter that was installed in 2007. Table 4.1-1 contains the results of the available PM control technologies.

TABLE 4.1-1 PM Control Technologies Identified for BART Analysis

Control Technology
Existing Fabric Filter
New Fabric Filter
COHPAC Baghouse
Electrostatic Precipitator

4.2 TECHNICAL DESCRIPTION AND FEASIBILITY ANALYSIS

The second step in the BART analysis procedure is a technical feasibility analysis of the options identified in Step 1. This analysis is presented below for each identified option.

4.2.1 FABRIC FILTER (FF)

A fabric filter or baghouse removes particulate by passing flue gas through filter bags. A pulse-jet fabric filter (PJFF), a common type of fabric filter, consists of isolatable compartments and a tube sheet which separates the particulate laden flue gas from the clean flue gas. The flue gas passes through the PJFF by flowing from the outside of the bag to the inside up the center of the bag through the hole in the tube sheet and out the PJFF. Fly ash particles are collected on the outside of the bags and the cleaned gas stream passes through the bag to the outlet of the fabric filter. Each filter bag alternates between relatively long periods of filtering and short periods of cleaning. During the cleaning period, fly ash that has accumulated on the bags is removed by pulses of air and falls into a hopper for disposal.

The existing fabric filter on BSP Unit I can achieve a filterable PM emission rate of 0.015 lb/mmBtu. Therefore, continuing the use of the existing fabric filter is a technically feasible option. Replacement of the existing fabric filter with a new fabric filter is feasible, but would provide little to no increase in removal efficiency or reduction in emission rate.

4.2.2 COHPAC

A Compact Hybrid PARTICULATE Collector (COHPAC) is a high air-to-cloth ratio pulse jet fabric filter located downstream of an existing ESP. The COHPAC acts as a polishing device for control of particulate emissions. The difference between a COHPAC and the fabric filter described above is that a COHPAC is installed after an ESP. Because Big Stone Plant does not have an ESP and already uses a fabric filter for particulate control, the use of a COHPAC is not considered further.

4.2.3 ELECTROSTATIC PRECIPITATOR (ESP)

ESPs are commonly used as the primary filterable PM control device on coal fired units. The ESP discharge electrodes generate a high voltage electrical field that gives the particulate matter an electric charge (positive or negative). The charged particles will then be collected on a collection plate. Technical characteristics associated with ESPs are described in Appendix C1.

It is anticipated that a new ESP installed at BSP could achieve a PM emission rate of approximately 0.015 lb/mmBtu. Therefore, the use of a new electrostatic precipitator is a technically feasible option. Replacement of the existing fabric filter with a new ESP is feasible, but would provide little to no increase in removal efficiency or reduction in emission rate.

The results of the feasibility analysis for the available BART alternatives are summarized in Table 4.2-1.

TABLE 4.2-1 – PM BART Feasibility Analysis Results

Control Technology	In Service on Existing Utility Boilers	Commercially Available	Technically Applicable To Big Stone Plant
Existing Fabric Filter	Yes	Yes	Yes
New Fabric Filter	Yes	Yes	Yes
COHPAC Baghouse	No ¹	Yes	No
New ESP	Yes	Yes	Yes

1 – While COHPAC has been installed on existing EGUs, it has not been installed in conjunction with an existing fabric filter.

4.3 RANK OF TECHNICALLY FEASIBLE PM CONTROL OPTIONS BY EFFECTIVENESS

The third step in the BART analysis procedure is to rank the technically feasible alternatives. However, because BSP Unit I currently uses a pulse-jet fabric filter that is the best technology available for particulate control and can achieve similar emission rates to new versions of the same technology or a new ESP replacing the existing fabric filter with new particulate control is inappropriate. Thus, the existing fabric filter is the highest ranked and only option evaluated further.

4.4 EVALUATION OF IMPACTS FOR FEASIBLE PM CONTROLS – UNIT I

Step four in the BART analysis procedure is the impact analysis. The BART Guidelines list four factors to be considered in the impact analysis:

- The costs of compliance;
- Energy impacts;
- Non-air quality environmental impacts; and
- The remaining useful life of the source.

Because Big Stone Plant Unit I currently uses a pulse-jet fabric filter that is the best technology available for particulate control and can achieve similar emission rates to new versions of the same technology replacing the existing fabric filter with new particulate control is inappropriate. Reviewing the four impacts listed above would provide no additional information regarding the type of technology to be selected to best achieve visual emissions improvement. However, as described in Section 1.3.6, the visibility impairment impacts due to particulate matter were included as part of the analysis.

4.4.1 VISIBILITY IMPACTS

A visibility analysis specifically for PM was not conducted due to the selection of the existing fabric filter and the conclusion that the alternatives would result in the same emission rate. Per the BART Guidelines, because BSP has “elected to apply the most stringent controls available...you need not conduct, or require the source to conduct, an air quality modeling analysis for the purpose of determining its visibility impacts.” (40 CFR 51. App. Y, IV.D.5.)

5.0 BART RECOMMENDATIONS

The presented emission rates in this section are the BART recommendation. However, because the accuracy of the cost estimate is $\pm 30\%$ and in some cases is greater than the variance of the estimated costs between control alternatives, the technology selected by Big Stone Plant to meet the BART recommendation may change. This section summarizes the analysis performed for each pollutant.

5.1 NO_x BART

Five types of NO_x control processes were identified for evaluation. Over-fire air (OFA), separated over-fire air (SOFA), Selective Non-Catalytic Reduction (SNCR), Rich Reagent Injection (RRI), Selective Catalytic Reduction (SCR) and combinations these technologies were evaluated for control effectiveness. Of these alternatives, stand alone SNCR and SCR were eliminated from further impacts analysis as BSP already has an OFA system in operation. A cost analysis of the remaining technologies eliminated RRI/SNCR/SOFA due to the operating costs.

Predicted visibility impairment impacts decreased significantly with the NO_x control technologies. The largest incremental impact reduction came from the application of SCR. However, the difference in impacts between OFA (lowest control level) and SCR (highest control level) is less than 0.5 dV, which is visibly indiscernible. The modeling also shows that SOFA must be applied to reduce visibility impacts due to the NO_x contribution below a discernable level of 0.5 dV. An analysis of the incremental cost-effectiveness of consecutively more stringent controls was performed for BSP Unit I. Installing and operating any control technology beyond SOFA would cost more than 24 million dollars per dV of visibility impairment improvement and would only improve predicted visibility impacts by an amount that is not discernable to the human eye.

Based on the analysis, SOFA is recommended as BART for BSP Unit I. Application of SOFA for NO_x control translates into a BART emission rate of 2,804 pounds per hour (0.50 pounds per million Btu of fuel heat input at 5,609 mmBtu/hr). The emission rate of 2,804 pounds per hour is recommended as the permit limit based upon a 30 day rolling average.

5.2 SO₂ BART

Three types of SO₂ control processes were identified for evaluation. While evaluating each process for BSP SO₂ control, fuel switching was eliminated due to the current use of low sulfur PRB coal. Wet FGD and semi-dry FGD at two levels of control were selected for further evaluation. A cost analysis of the remaining technologies eliminated wet FGD at the presumptive emissions rate due to the higher cost for achieving the same emission rate as semi-dry FGD.

The difference in impacts between semi-dry FGD and wet FGD are 0.009 dV apart, which is visibly indiscernible. The modeling also shows that semi-dry FGD at 90% control must be applied to reduce

visibility impacts due to the SO₂ contribution below a discernable level of 0.5 dV. An analysis of the incremental cost-effectiveness of consecutively more stringent controls was performed for BSP Unit I. Installing and operating wet FGD over semi-dry FGD would cost 608 million dollars per dV of visibility impairment improvement and would only improve predicted visibility impacts by an amount that is not discernable to the human eye.

Based on the analysis, semi-dry FGD is recommended as BART for BSP Unit I. Application of semi-dry FGD for SO₂ control translates into a BART emission rate of 505 pounds per hour (0.09 pounds per million Btu of fuel heat input at 5,609 mmBtu/hr heat input). The emission rate of 505 pounds per hour is recommended as the permit limit based upon a 30 day rolling average.

5.3 PM BART

For the PM evaluation, three post combustion control technologies were selected for evaluation in addition to the existing pulse-jet fabric filter. While evaluating each technology for BSP Unit 1 PM control, a COHPAC baghouse was eliminated from the evaluation. A new fabric filter and ESP were eliminated in the analysis because the existing fabric filter provides a similar level of control effectiveness without the additional capital costs.

Because BSP Unit I currently uses a pulse-jet fabric filter that is the best technology available for particulate control and is the only technology remaining in the analysis, the impact review can be abbreviated.

Reviewing the cost of compliance, the energy and non-air quality environmental impacts, other pollution control equipment in use at the source, and the remaining useful life of the source would provide no additional information to change technologies from the existing fabric filter. The modeling was conducted with a constant PM emission rate of 84.1 pounds per hour.

Based upon selection of the best available PM control technology, maintaining the existing pulse-jet fabric filter is recommended as BART for BSP Unit I. The corresponding BART emission rate for the existing fabric filter is 84.1 pounds per hour (0.015 pounds per million Btu of fuel heat input at 5,609 mmBtu/hr heat input). The emission rate of 84.1 pounds per hour is recommended as the permit limit based upon a 30 day rolling average.

5.4 COMBINED BART

As indicated previously, this report presents the analysis of control technologies for NO_x, SO₂, and PM for BSP Unit I. The BART control technology recommendations for the individual pollutants are based upon the steps outlined in the EPA guideline. Modeling to determine visibility impairment was performed using the recommended BSP Unit I BART emission rates for NO_x, SO₂, and PM. The 98th percentile results are provided in Table 5.4-1.

TABLE 5.4-1 – Visibility Impairment Impacts from Combined Emissions

Control Technique	NO_x Emission Rate (lb/hr)	SO₂ Emission Rate (lb/hr)	PM Emission Rate (lb/hr)	Visibility Impairment Impact (dV)
BART	2,804	505	84.1	0.493

The results of the visibility impairment modeling for BSP showed that the proposed BART emissions rates for NO_x, SO₂ and PM caused no Class I area to exceed 0.5 dV for predicted visibility impairment impact (98th percentile) with Boundary Waters Canoe Area Wilderness (Boundary Waters) showing the highest predicted visibility impairment impact at 0.493 dV for the 2007 modeled year. Modeled visibility impairment impacts decreased significantly with the addition of the BART controls.

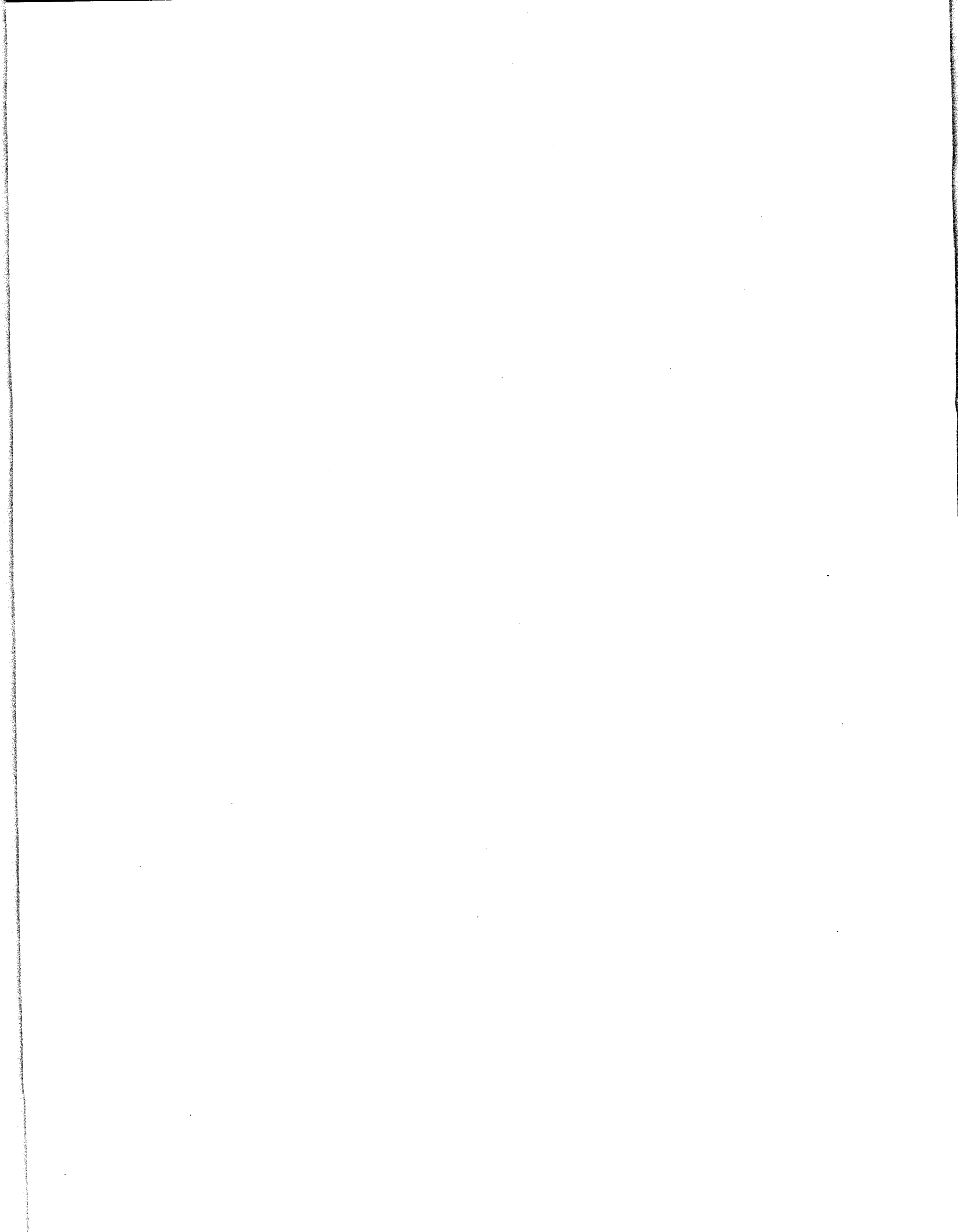

APPENDIX A

Technical Feasibility Assessment Details for NO_x Controls (A1)

CUECost Input Summary (A2)

Summary of Modeling Results (A3)

A1 Technical Feasibility Assessment of NO_x Control Alternatives

Uncontrolled NO_x emissions from a coal-fired electric generating unit are highly dependent on type of firing method, amount of solid fuel fired per unit time and furnace volume, and the fuel's basic combustion properties and elemental composition. The methods for reduction of such emissions:

- either prevent pollution, i.e., use inherently lower-emitting processes/practices which produce fewer NO_x emissions during the power generation process; or
- involve improvements to, or provide new add-on controls that, reduce emissions after they are produced before they are emitted from the facility; or
- are combinations of inherently lower-emitting processes and add-on controls.

There are two basic categories of NO_x emission control alternatives:

- Combustion controls; and
- Post-Combustion controls.

A significant number of the identified control options have been commercially-available, installed, and operating in many full-scale, permanent installations in the United States for five years or more.

Similar to the dependency of the uncontrolled emissions being based on the unit type, the applicability of the control technologies are also dependent upon the type of coal-fired unit.

Combustion controls, such as over-fire air (OFA) or separated over-fire (SOFA) air are applicable to cyclone fired units. Low-NO_x burners (LNBs), while commonly applied to pulverized coal-fired boilers, are not applicable to cyclone fired units since initial combustion occurs in the barrel-shaped cyclone and not in the furnace chamber as is the case for the pulverized coal-fired boiler.

Selective Catalytic Reduction (SCR) and Selective Non-Catalytic Reduction (SNCR) are post-combustion technologies that have been applied on bituminous or sub-bituminous coal-fired boilers. Others, mostly comprised of a combination of available control technologies, are often referred to as "hybrid" or "layered" control technologies. Variations of SNCR, such as more recently developed "Rich Reagent Injection" (RRI) technology, have only been demonstrated on a limited number of cyclone-fired boilers. In most of the "layered" control combination and emerging control cases, the NO_x control technology has been demonstrated to be capable of controlling the targeted pollutant(s) on either:

- a full-scale basis, but only with temporary equipment; or

- a full-scale basis, with permanent equipment but in a limited number of installations.

A1.1 Combustion Controls

Nitrogen oxides (NO_x) are produced when nitrogen in the fuel and combustion air are exposed to high temperatures. Nitrogen oxide (NO) is the most predominant form of NO_x emissions, along with nitrogen dioxide (NO₂). The formation of these compounds in utility powerplant boilers is sensitive to the method of firing and combustion controls utilized. The techniques employed for mixing the combustion air and fuel, which creates flames and high temperature combustion products, results from the rapid oxidization of carbon, hydrogen, and other exothermic reactions. Cyclone-fired boilers, by design, create intense heat release rates to melt and fluidize the coal ash introduced into the barrel-shaped furnaces. This produces very high uncontrolled NO_x emissions.

Combustion controls employ methods that reduce the amount of NO_x emissions created in the combustion zone of the boiler prior to exhausting the flue gases from the furnace (upstream of the convective heat transfer zones). This results in fewer emissions that may require subsequent reduction from applicable post-combustion techniques.

A1.1.1 Low-NO_x Burners (LNB)

LNBs are not applicable to cyclone-fired boilers¹. This is due to the physical constraints imposed by the cyclone furnaces' (barrels) length and diameter, and the incompatibility with the amount of heat released and flame dispersion patterns, and insufficient amount of fine coal particles required to sustain stable combustion associated with air-staged firing of coal using low-NO_x burners with pulverized fuel. This alternative was eliminated from consideration for potential additional NO_x emissions reductions from Big Stone's boiler.

A1.1.2 Over-fire Air (OFA) or Separated Over-fire Air (SOFA)

Over-fire Air (OFA) and Separated over-fire air (SOFA) systems are commonly-applied, combustion-related NO_x emission reduction technology. Separated Overfire Air (SOFA) is an air-staging NO_x reduction technique that is usually based on withholding 15 to 20 percent of the total combustion air conventionally supplied to the firing zone. It is believed that Big Stone's boiler would be a suitable candidate for the installation of SOFA and for additional NO_x control, if this is necessary.

For typical cyclone coal-fired boilers, the operation of SOFA involves diverting approximately 20 percent of the secondary combustion air from the burner barrels, forcing the cyclones to operate fuel-rich. The diverted combustion air is then injected in the upper furnace, where combustion is completed.

SOFA can achieve significant NO_x reduction, typically 30 to 70 percent on typical cyclone coal-fired boilers with this typical amount of air staging. A summary of several of the first OFA retrofits to cyclone-fired boilers is described in published technical papers^{1,2}. At least thirty nine existing cyclone-fired boilers, firing eastern bituminous, midwestern bituminous, and western subbituminous ("Powder River Basin") coals in units ranging in size from 50 to 1150 MW, have been retrofitted with commercial SOFA since 1998³. Additional cyclone-fired boilers have installed separated overfire air systems in conjunction with commercial fuel reburn retrofit projects⁴. Other NO_x emission reduction demonstration projects, primarily sponsored by U.S. Department of Energy National Energy Technology Laboratory's Clean Coal Technology Program⁵, and other fuel reburn retrofit projects⁶ have also installed separated overfire air on cyclone boilers.

A basic form of separated overfire air (SOFA) can be applied and installed on Big Stone. There are potential impacts and limitations unique to cyclone boilers firing PRB that should be recognized as part of this emission reduction technology application.

A key aspect of successfully applying and operating separated overfire air on a cyclone-fired boiler is the ability to maintain adequate molten coal ash (slag) formation and flow within the barrels and slag taps. As secondary combustion air is diverted, less heat is released during air-staged combustion from the intentional formation of carbon monoxide, and temperatures within the cyclones decreases. The degree to which the cyclones can be operated with less than theoretical (stoichiometric) combustion air directly contributes to less NO_x formation and further in-furnace emission reduction but also risks solidification of the molten coal ash. There are several challenges anticipated for implementing SOFA, primarily involving the ability to route large SOFA ductwork for diverting secondary air from the windboxes. These are believed to be solvable. Using a basic SOFA system, assuming a sustainable level of NO_x emissions control with the operation of modestly air-staged cyclone furnaces with suitable combustion controls, is considered feasible for Big Stone.

A1.2 Post-Combustion Controls

Post-combustion controls deal with techniques that thermally or chemically-treat the flue gases to reduce NO_x emissions after they have exited the boiler's lower furnace. In the case of Big Stone Unit I, this primarily involves forms of selective catalytic reduction (SCR) and selective non-catalytic reduction (SNCR) technologies.

A1.2.1 Selective Non-Catalytic Reduction (SNCR)

Selective Non-Catalytic Reduction (SNCR) technologies are all post-combustion types of boiler NO_x emission controls. These technologies promote NO_x reduction with chemical reactions that are insensitive to the specific fuel types whose combustion products are being treated. While the large majority of boiler applications to date have been on pulverized coal-fired units burning eastern bituminous fuels, SNCR has been used to reduce NO_x emissions on utility boilers burning eastern bituminous coal, midwestern bituminous coal, and, to a lesser extent, western subbituminous coal. SNCR has also been used with fuel oil and natural gas-fired units. SNCR (and hydrocarbon-enhanced SNCR) technologies can each be applied to fossil fuel-fired boilers with or without the use of a SOFA system. The ability to apply SNCR does not appear to be dependent directly on the type of burners (wall-fired, tangentially-fired, and cyclone-fired) employed in the boilers where it has been installed, with or without overfire air in full operation. Operation at these plants has demonstrated that SNCR can decrease NO_x emissions as much as 15-40% at full load, most typically between 25-35%.^{7, 8, 9}

In the conventional SNCR process, urea or ammonia is injected into the boiler in a region where the combustion gas temperature is in the 1700 to 2100 degrees F range. Under these temperature conditions, the urea reagent [CO(NH₂)₂] or ammonia [NH₃] reacts with the nitrogen oxides [NO_x], forming elemental nitrogen [N₂] and water, reducing NO_x emissions.

SNCR can be applied and installed on the Big Stone boiler in combination with basic or separated form of over-fire air (OFA).

A1.2.2 Rich Reagent Injection (RRI)

Rich Reagent Injection (RRI) is a NO_x control technology that has been developed and demonstrated specifically for use on cyclone boilers. Rich Reagent Injection is an SNCR process that involves the injection of urea into the lower furnace between the cyclones and the SOFA ports. RRI targets a high

temperature, fuel-rich zone within the boiler-furnace environment immediately adjacent to the cyclone burners, and requires temperatures in the range of 2400 to 3100 degrees F. The combustion gases must be essentially devoid of free oxygen, in order to avoid oxidizing the nitrogen contained in the injected reagent, which would create NO_x emissions instead of reducing them.

The RRI process for NO_x reduction must be used in conjunction with air-starved (substoichiometric staged-air) cyclone combustion resulting from the installation and operation of an OFA system. The cyclones' air/fuel stoichiometry must be carefully controlled to maintain fuel-rich conditions for the RRI process to be effective. This introduces oxygen in the same vicinity as the reagent injection ports, and will disrupt the beneficial action of the fuel-rich zone and amine reagent to significantly reduce NO_x emissions. Without SOFA, RRI will not contribute positively to NO_x emissions control on Big Stone Unit I boiler. This places a large emphasis on the expected performance of SOFA in order for RRI to be successful in producing significant additional NO_x emissions reduction on PRB-fired cyclone boilers.

The three zones of a Rich Reagent Injection SNCR application on a boiler with separated overfire air are shown as a sectional side elevation view of the furnace¹¹ in Figure A.1-4.

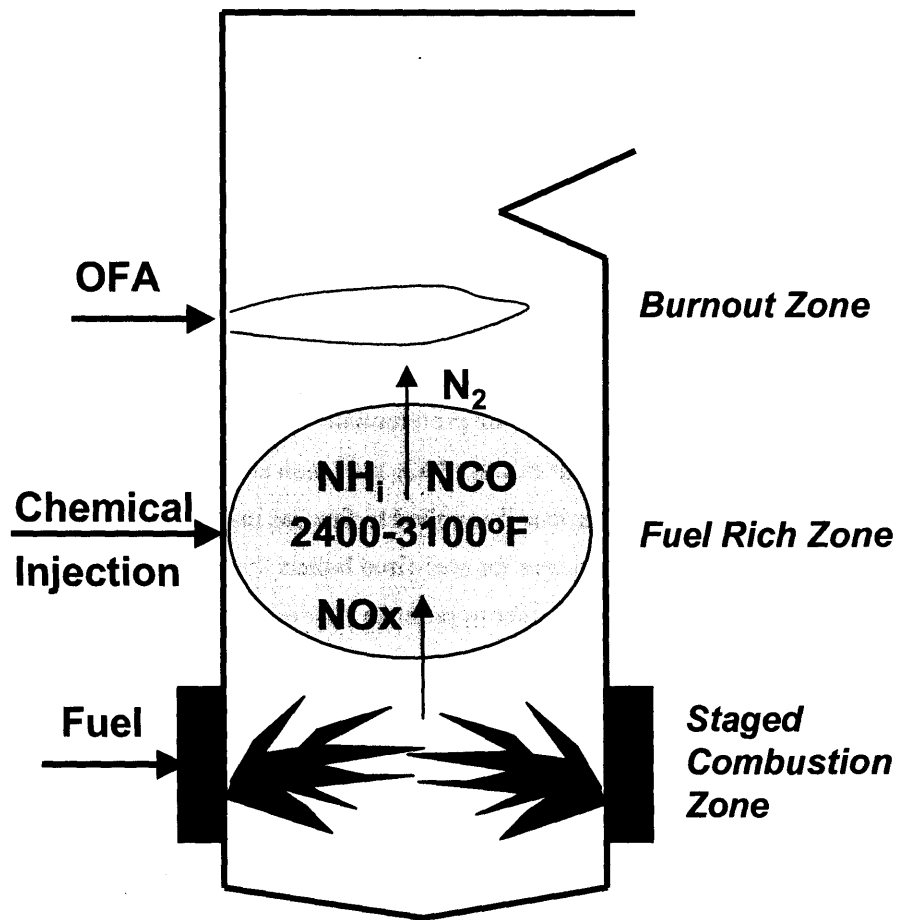

Figure A.1-4 Rich Reagent Injection Application on Boiler With Overfire Air¹⁰

The Rich Reagent Injection (RRI) process has been successfully demonstrated on at least two cyclone-fired boilers, with the most recent installation at Ameren's Sioux Unit I, a 500 MW boiler firing a blend of PRB and midwestern bituminous coals.

The NO_x emission reduction reagent injection for RRI processes must be precisely located and carefully controlled to be effective. Operation outside of the required operating ranges can even result in increased NO_x emissions. Extensive computational fluid dynamic (CFD) simulations are needed to determine the optimum injection points. Boiler operating conditions will change with unit load and varying fuel characteristics. The RRI process control systems must be able to adjust for these changing conditions.

RRI has the potential to provide a moderate degree of NO_x reduction on coal-fired cyclone boilers. Rich Reagent Injection can be applied and installed on Big Stone boiler only with separated over-fire air (SOFA).

A1.2.3 Selective Catalytic Reduction (SCR)

The lowest NO_x emission levels from coal-fired utility boilers are typically achieved by installing and operating selective catalytic reduction (SCR) technology. In the SCR process, the gas stream is passed through a catalyst bed in the presence of ammonia to reduce NO_x to molecular nitrogen and water. The process is termed “selective” because the ammonia preferentially reacts with the NO_x rather than with the oxygen in the flue gas. A catalyst is used to enhance NO_x reduction and ammonia utilization at appropriate flue gas temperatures. SCR is usually applied to flue gas in the 600°F to 750°F temperature range. There are variations in the SCR process for coal-fired boilers that mostly involve locations in the flue gas path where the catalyst is placed in order to promote the desired NO_x emission reduction effect. These are described below.

For coal-fired boilers, a conventional SCR reactor utilizes readily-available catalyst materials and reagent in the form of ammonia. A conventional SCR reactor is commonly installed in a high-dust, hot-side arrangement, located between the economizer outlet and air heater inlet, where the flue gas temperature is within the desired operating range for the SCR catalyst.

A schematic graphic diagram for a conventional high-dust, hot-side SCR system on a boiler with a flue gas desulfurization system and stack gas reheat is provided in Figure A.1-5.

Figure A.1-5 Conventional SCR Arrangement
with FGD Scrubber Outlet Reheat

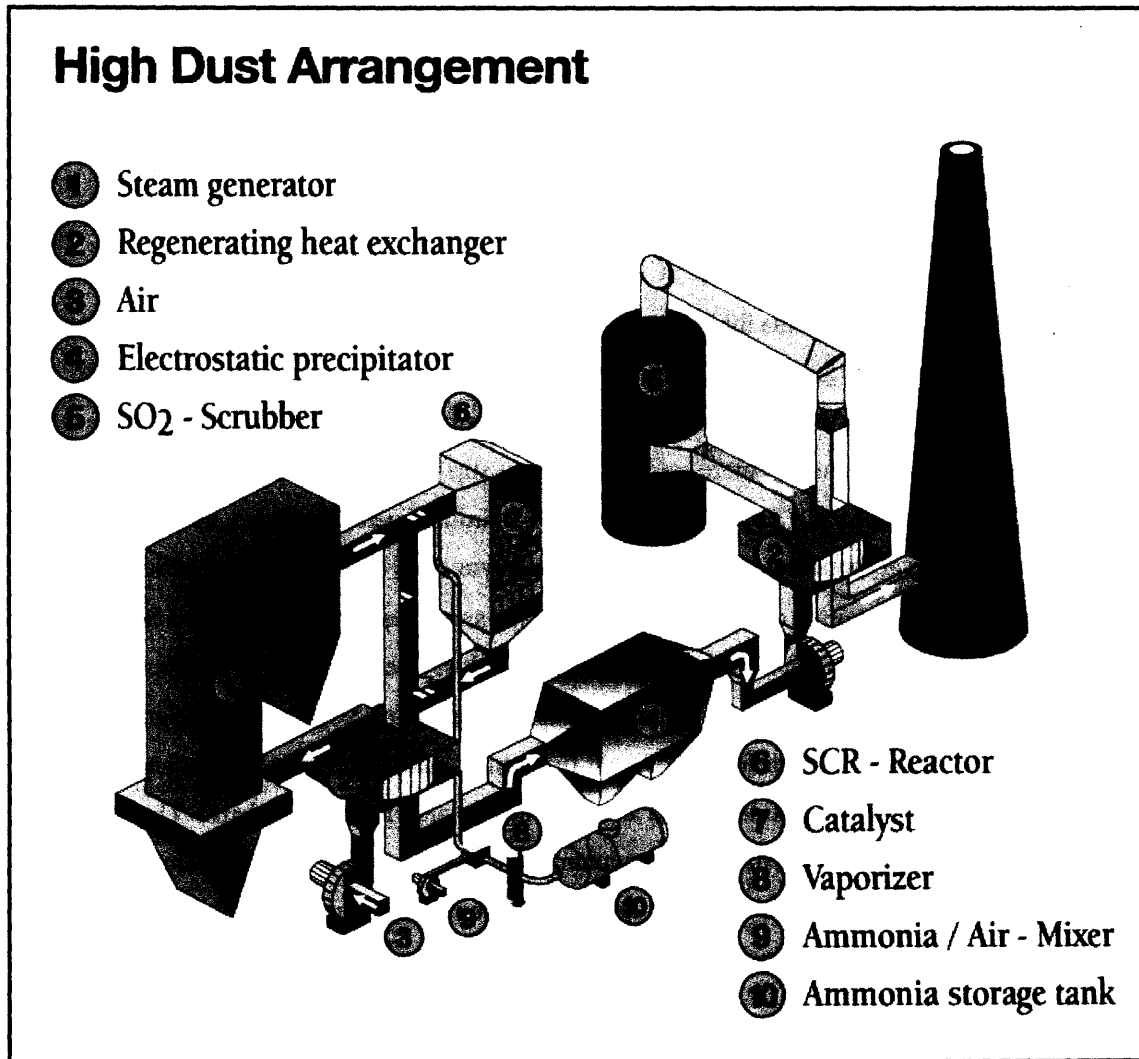

(figure copied from Wheelabrator Air Pollution Control literature)

SCR technology has been installed on several pulverized coal and cyclone boilers firing bituminous and subbituminous coal in the United States. The installation of SCR systems has been completed on approximately 22 cyclone units. Several SCR installations have been retrofit on existing cyclone-fire boilers burning western subbituminous coal (or PRB blended with midwestern bituminous coal). For cyclone coal-fired utility boilers retrofitted with SCR technology, all were originally designed to burn bituminous coal.

Two byproducts from the high-dust, hot-side SCR process are ammonia slip and SO₃:

- Ammonia Slip: Slip is ammonia that is unreacted in the NO_x emission reduction process. Maximum ammonia slip for a gas fired unit is usually 10 ppmvd whereas, on a coal fired unit, ammonia slip below 2 ppm is desired. For certain applications, this concentration can be problematic, therefore requiring more catalyst to reduce slip. Most new SCR applications have ammonia slip guaranteed at a 2 ppmvd maximum for an initial operating period, and are expected to continue to operate at these low ammonia slips levels beyond the end of the initial period.
- SO₃: Due to the composition of typical SCR catalysts, a small percentage of inherent SO₂ will be oxidized to SO₃. This oxidation can be controlled by catalyst selection and can be less than 1%. SO₂ to SO₃ oxidation must be carefully controlled to avoid creating SO₃ levels sufficiently high to raise the possibility of air heater fouling. A unit firing high-sulfur coal with SCR technology is especially vulnerable to SO₂ oxidation and ammonia slip-related fouling problems. The deposition and fouling is due to formation of solid ammonium sulfate ((NH₄)₂SO₄) and liquid ammonium bisulfate (NH₄HSO₄). The most important design variable is optimizing the catalyst selection and amount of catalyst that will reduce NO_x emissions, control ammonia slip, and minimize SO₂ oxidation.

As posted on Electric Power Research Institute Inc.'s (EPRI's) website regarding the impact of coal type on SCR catalyst life and performance, a recent EPRI study¹¹ produced field data analyzed from an "In-Situ Mini SCR Reactor" system installed in a typical "high-dust" location at seven different test sites, including four firing PRB coal, one firing Texas lignite, one firing high-sulfur eastern bituminous coal, and one firing a PRB/eastern bituminous coal blend. The PRB/bituminous coal blend test was performed at AmerenUE's Sioux Station, on one of the two 500 MW cyclone-fired boilers. This study found that the cyclone unit firing the PRB/bituminous coal blend exhibited the fastest rate of catalyst activity degradation. Also, the higher deactivation rates seen at this site were due to economizer exit flue gas temperatures being significantly higher than at the other sites. A comparison of the Texas lignite and one

of the PRB-fired sites of two different catalysts' deactivation was more a function of trace elements in the flue gas and flyash than the specific catalyst type or formulation.

Based upon this technical assessment that looked at the various design and operational issues associated with the installation of hot-side, high-dust SCR technology, SCR is considered a feasible option for Unit I at Big Stone.

References for Appendix A1:

1. "The State of the Art in Cyclone Boiler NO_x Reduction", by O'Connor, Dave, Himes, Rick, and Facchiano, Tony (Electric Power Research Institute), presented at the EPRI-DOE-EPA Combined Utility Air Pollutant Control Symposium, Atlanta, GA, August 16-20, 1999.
2. "B&W's Advances on Cyclones NO_x Control Via Fuel and Air Staging Technologies", by Farzan, H., Maringo, G., Johnson, D. W., and Wong, D.K. (Babcock & Wilcox, Co.), Beard, C.T. (Eastman Kodak Company), and Brewster, S.E. (Tennessee Valley Authority), presented at the EPRI-DOE-EPA Combined Utility Air Pollutant Control Symposium, Atlanta, GA, August 16-20, 1999. Available at B&W's internet website: <http://www.babcock.com/pgg/tt/pdf/BR-1683.pdf>
3. Burns & McDonnell internal database for NO_x reduction projects.
4. B&W experience list September 18, 2002.
5. "Reburning Projects in the Department of Energy's Clean Coal Technology Demonstration Program", by Mann, Al and Ruppel, Tom (Parsons Corporation), and Sarkus, Tom (National Energy Technical Laboratory), presented at the 2004 DOE-NETL Conference on Reburning for NO_x Control, Morgantown, WV, May 18, 2004. A reburn-related document (an updated version of a poster from the May 18 Conference) is titled "Scorecard on Reburning 6/1/2004" by Al Mann and Tom Ruppel, Parsons Corporation, available on-line at: <http://www.netl.doe.gov/publications/proceedings/04/NOx/posters/Reburning%20Scorecard.pdf>
6. GE Energy (formerly GE-EER) experience list September 29, 2005.
7. Fuel Tech experience list dated 1/28/2005.
8. SNCR "White Paper", Institute of Clean Air Companies, Inc. (ICAC), SNCR Committee, May 2000, Fuel Tech website <http://www.fueltechnv.com/pdf/TPP-534.pdf>.
9. RJM experience list September 3, 2004.
10. "Improved Rich Reagent Injection (RRI) Performance For NO_x Control In Coal Fired Utility Boilers" by Cremer, Marc A. and Wang, Huafeng D. (Reaction Engineering International), Boll, David E. (AmerenUE), Schindler, Edmund (RJM Corporation), and Vasquez, Edmundo RMT, Inc. (Alliant Energy Corp.), presented at 2003 U.S. DOE Conference on SCR and SNCR for NO_x Control, Pittsburgh, PA, October 29-30, 2003.
11. "Ash Impacts on SCR Catalyst Performance", Energy & Environmental Research Center (EERC) of the University of North Dakota", Benson, Steven A., Ph.D., October 2005.

A2 CUECost Input Summary

CUECost - Air Pollution Control Systems Economics Spreadsheet

<i>APC Technology Choices</i>				
Description	Units	Case 1	Case 2	Case 3
FGD Process (1 = LSFO, 2 = LSD)	Integer	1	1	1
Particulate Control (1 = Fabric Filter, 2 = ESP)	Integer	1	1	1
NOx Control (1 = SCR, 2 = SNCR, 3 = LNBS, 4 = NGR)	Integer	1	1	1
<i>INPUTS</i>				
Description	Units	Case 1	Case 2	Case 3
<i>General Plant Technical Inputs</i>				
Location - State	Abbrev.	SD	SD	SD
MW Equivalent of Flue Gas to Control System	MW	475	475	475
Net Plant Heat Rate	Btu/kWhr	11,809	11,809	11,809
Plant Capacity Factor	%	85%	85%	85%
Total Air Downstream of Economizer	%	120%	120%	120%
Air Heater Leakage	%	10%	10%	10%
Air Heater Outlet Gas Temperature	°F	320	320	320
Inlet Air Temperature	°F	70	70	70
Ambient Absolute Pressure	In. of Hg	28.75	28.75	28.75
Pressure After Air Heater	In. of H2O	-15	-15	-15
Moisture in Air	lb/lb dry air	0.013	0.013	0.013
Ash Split:				
Fly Ash	%	80%	80%	80%
Bottom Ash	%	20%	20%	20%
Seismic Zone	Integer	0	0	0
Retrofit Factor (1.0 = new, 1.3 = medium, 1.6 = difficult)	Integer	1.5	1.5	1.5
Select Coal	Integer	1	1	1
Is Selected Coal a Powder River Basin Coal?	Yes / No	Yes	Yes	Yes
<i>Economic Inputs</i>				
Cost Basis - Year Dollars	Year	2008	2008	2007
Sevice Life (levelization period)	Years	30	30	30
Inflation Rate	%	3%	3%	3%
After Tax Discount Rate (current \$'s)	%	9%	9%	9%
AFDC Rate (current \$'s)	%	11%	11%	11%
First-year Carrying Charge (current \$'s)	%	10%	10%	10%
Levelized Carrying Charge (current \$'s)	%	10%	10%	10%
First-year Carrying Charge (constant \$'s)	%	10%	10%	10%
Levelized Carrying Charge (constant \$'s)	%	10%	10%	10%
Sales Tax	%	6%	6%	0%
Escalation Rates:				
Consumables (O&M)	%	3%	3%	3%

CUECost - Air Pollution Control Systems Economics Spreadsheet

Capital Costs:				
Is Chem. Eng. Cost Index available?	Yes / No	Yes	Yes	Yes
If "Yes" input cost basis CE Plant Index	Integer	575.4	575.4	575.4
If "No" input escalation rate.	%	3%	3%	3%
Construction Labor Rate (Not Used N Calc)	\$/hr	\$35	\$35	\$35
Prime Contractor's Markup	%	3%	3%	3%
Operating Labor Rate	\$/hr	\$48	\$48	\$48
Power Cost	Mills/kWh	25	25	25
Steam Cost	\$/1000 lbs	3.5	3.5	3.5
<u>Limestone Forced Oxidation (LSFO) Inputs</u>				
Any By-Pass around the scrubber (1 = yes, 2 = no)		2	2	2
Percent of By-Passed Gas	%	0.0%	0.0%	0.0%
SO2 Removal Required	%	95.0%	83.0%	95.0%
L/G Ratio	gal / 1000 acf	125	125	110
Design Scrubber with Dibasic Acid Addition? (1 = yes, 2 = no)	Integer	2	2	2
Adiabatic Saturation Temperature	°F	132	132	135
Reagent Feed Ratio (Mole CaCO3 / Mole SO2 removed)	Factor	1.05	1.05	1.03
Scrubber Slurry Solids Concentration	Wt. %	15%	15%	15%
Stacking, Landfill, Wallboard (1 = stacking, 2 = lanfill, 3 = wallboard)	Integer	2	2	3
Number of Absorbers (Max. Capacity = 700 MW per absorber)	Integer	1	1	1
Absorber Material (1 = alloy, 2 = RLCS)	Integer	1	1	1
Absorber Pressure Drop	in. H2O	6	6	6
Reheat Required ? (1 = yes, 2 = no)	Integer	2	2	2
Amount of Reheat	°F	0	0	0
Reagent Bulk Storage	Days	60	60	30
Reagent Cost (delivered)	\$/ton	\$24	\$24	\$12
Landfill Disposal Cost	\$/ton	\$4	\$4	\$30
Stacking Disposal Cost	\$/ton	\$2	\$2	\$6
Credit for Gypsum Byproduct	\$/ton	\$0	\$0	\$0
Maintenance Factors by Area (% of Installed Cost)				
Reagent Feed	%	3%	3%	3%
SO2 Removal	%	3%	3%	3%
Flue Gas Handling	%	3%	3%	3%
Waste / Byproduct	%	3%	3%	3%
Support Equipment	%	3%	3%	3%
Contingency by Area (% of Installed Cost)				
Reagent Feed	%	20%	20%	20%
SO2 Removal	%	20%	20%	20%
Flue Gas Handling	%	20%	20%	20%
Waste / Byproduct	%	20%	20%	20%
Support Equipment	%	20%	20%	20%
General Facilities by Area (% of Installed Cost)				
Reagent Feed	%	10%	10%	10%
SO2 Removal	%	10%	10%	10%

CUECost - Air Pollution Control Systems Economics Spreadsheet

Flue Gas Handling	%	10%	10%	10%
Waste / Byproduct	%	10%	10%	10%
Support Equipment	%	10%	10%	10%
Engineering Fees by Area (% of Installed Cost)				
Reagent Feed	%	10%	10%	10%
SO2 Removal	%	10%	10%	10%
Flue Gas Handling	%	10%	10%	10%
Waste / Byproduct	%	10%	10%	10%
Support Equipment	%	10%	10%	10%
<u>Lime Spray Dryer (LSD) Inputs</u>				
SO2 Removal Required	%	90%	83%	90%
Adiabatic Saturation Temperature	°F	132	132	135
Flue Gas Approach to Saturation	°F	20	20	25
Spray Dryer Outlet Temperature	°F	152	152	160
Reagent Feed Ratio	Factor	0.92	0.85	0.92
(Mole CaO / Mole Inlet SO2)				
Recycle Rate	Factor	30	30	30
(lb recycle / lb lime feed)				
Recycle Slurry Solids Concentration	Wt. %	35%	35%	35%
Number of Absorbers	Integer	2	2	1
(Max. Capacity = 300 MW per spray dryer)				
Absorber Material	Integer	1	1	2
(1 = alloy, 2 = RLCS)				
Spray Dryer Pressure Drop	in. H2O	5	5	5
Reagent Bulk Storage	Days	60	60	30
Reagent Cost (delivered)	\$/ton	\$145	\$145	\$60
Dry Waste Disposal Cost	\$/ton	\$4	\$4	\$30
Maintenance Factors by Area (% of Installed Cost)				
Reagent Feed	%	2%	2%	2%
SO2 Removal	%	2%	2%	2%
Flue Gas Handling	%	2%	2%	2%
Waste / Byproduct	%	2%	2%	2%
Support Equipment	%	2%	2%	2%
Contingency by Area (% of Installed Cost)				
Reagent Feed	%	20%	20%	20%
SO2 Removal	%	20%	20%	20%
Flue Gas Handling	%	20%	20%	20%
Waste / Byproduct	%	20%	20%	20%
Support Equipment	%	20%	20%	20%
General Facilities by Area (% of Installed Cost)				
Reagent Feed	%	10%	10%	10%
SO2 Removal	%	10%	10%	10%
Flue Gas Handling	%	10%	10%	10%
Waste / Byproduct	%	10%	10%	10%
Support Equipment	%	10%	10%	10%
Engineering Fees by Area (% of Installed Cost)				
Reagent Feed	%	10%	10%	10%
SO2 Removal	%	10%	10%	10%
Flue Gas Handling	%	10%	10%	10%
Waste / Byproduct	%	10%	10%	10%
Support Equipment	%	10%	10%	10%

CUECost - Air Pollution Control Systems Economics Spreadsheet

<u>Particulate Control Inputs</u>				
Outlet Particulate Emission Limit	lbs/MMBtu	0.015	0.015	0.015
Fabric Filter:				
Pressure Drop	in. H2O	9	9	9
Type (1 = Reverse Gas, 2 = Pulse Jet)	Integer	1	2	1
Gas-to-Cloth Ratio	ACFM/ft ²	2.3	3.5	2.3
Bag Material (RGFF fiberglass only) (1 = Fiberglass, 2 = Nomex, 3 = Ryton)	Integer	1	3	1
Bag Diameter	inches	12	6	12
Bag Length	feet	30	26	30
Bag Reach		3	3	3
Compartments out of Service	%	10%	10%	10%
Bag Life	Years	5	3	5
Maintenance (% of installed cost)	%	5%	5%	5%
Contingency (% of installed cost)	%	20%	20%	20%
General Facilities (% of installed cost)	%	10%	10%	10%
Engineering Fees (% of installed cost)	%	10%	10%	10%
ESP:				
Strength of the electric field in the ESP = E	kV/cm	10.0	10.0	10.0
Plate Spacing	in.	12	12	16
Plate Height	ft.	36	36	36
Pressure Drop	in. H2O	3	3	2
Maintenance (% of installed cost)	%	5%	5%	5%
Contingency (% of installed cost)	%	20%	20%	20%
General Facilities (% of installed cost)	%	10%	10%	10%
Engineering Fees (% of installed cost)	%	10%	10%	10%
<u>NOx Control Inputs</u>				
<u>Selective Catalytic Reduction (SCR) Inputs</u>				
NH3/NOX Stoichiometric Ratio	NH3/NOX	0.8	0.8	0.800641299
NOX Reduction Efficiency	Fraction	0.80	0.84	0.70
Inlet NOx	lbs/MMBtu	0.5	0.65	0.15
Space Velocity (Calculated if zero)	1/hr	0	0	0
Overall Catalyst Life	years	2	2	3
Ammonia Cost	\$/ton	325	325	325
Catalyst Cost	\$/ft ³	150	150	150
Solid Waste Disposal Cost	\$/ton	11.48	11.48	11.48
Maintenance (% of installed cost)	%	1.5%	1.5%	1.5%
Contingency (% of installed cost)	%	20%	20%	20%
General Facilities (% of installed cost)	%	5%	5%	5%
Engineering Fees (% of installed cost)	%	10%	10%	10%
Number of Reactors	integer	2	2	2
Number of Air Preheaters	integer	2	2	2
<u>Selective NonCatalytic Reduction (SNCR) Inputs</u>				
Reagent	1:Urea 2:Ammonia	1	1	1
Number of Injector Levels	integer	3	3	3
Number of Injectors	integer	18	18	18
Number of Lance Levels	integer	0	0	0

CUECost - Air Pollution Control Systems Economics Spreadsheet

Number of Lances	integer	0	0	0
Steam or Air Injection for Ammonia	integer	1	1	1
NOX Reduction Efficiency	Fraction	0.30	0.60	0.46
Inlet NOx	lbs/MMBtu	0.5	0.5	0.65
NH3/NOX Stoichiometric Ratio	NH3/NOX	2	4	2
Urea/NOX Stoichiometric Ratio	Urea/NOX	2	4	2
Urea Cost	\$/ton	380	380	380
Ammonia Cost	\$/ton	325	325	325
Water Cost	\$/1,000 gal	0.407	0.407	0.407
Maintenance (% of installed cost)	%	1.5%	1.5%	1.5%
Contingency (% of installed cost)	%	20%	20%	20%
General Facilities (% of installed cost)	%	5%	5%	5%
Engineering Fees (% of installed cost)	%	10%	10%	10%
<u>Low NOX Burner Technology Inputs</u>				
NOX Reduction Efficiency	fraction	0.35	0.35	0.35
Boiler Type	T:T-fired, W:Wall	T	T	T
Retrofit Difficulty	L:Low, A:Average, H:High	A	A	A
Maintenance Labor (% of installed cost)	%	0.8%	0.8%	0.8%
Maintenance Materials (% of installed cost)	%	1.2%	1.2%	1.2%
<u>Natural Gas Reburning Inputs</u>				
NOX Reduction Efficiency	fraction	0.61	0.61	0.61
Gas Reburn Fraction	fraction	0.15	0.15	0.15
Waste Disposal Cost	\$/ton	11.48	11.48	11.48
Natural Gas Cost	\$/MMBtu	2.31	2.31	2.31
Maintenance (% of installed cost)	%	1.5%	1.5%	1.5%
Contingency (% of installed cost)	%	20%	20%	20%
General Facilities (% of installed cost)	%	2%	2%	2%
Engineering Fees (% of installed cost)	%	10%	10%	10%
<u>Sulfuric Acid Mist Control Inputs</u>				

A3 Summary of Modeling Results

**Modeling Report for a BART
Assessment of the Big Stone I
Coal-Fired Power Plant,
Big Stone City, South Dakota
Part 2 – BART Controls**

October 2009

Prepared For:

**Big Stone I
Otter Tail Power Company,
Big Stone City, South Dakota**

Prepared By:

**TRC Environmental Corporation
650 Suffolk Street
Lowell, Massachusetts 01854
(978) 970-5600**

TABLE OF CONTENTS

	Page
1. INTRODUCTION.....	1-1
2. SOURCE DESCRIPTION	2-1
3. GEOPHYSICAL AND METEOROLOGICAL DATA, AIR QUALITY MODELING OPTIONS.....	3-1
4. RESULTS	4-1
5. REFERENCES.....	5-1

LIST OF FIGURES

	Page
Figure 3-1. Terrain elevations for the CALMET and CALPUFF modeling domain at 4 km resolution. The locations of the Big Stone facility and Class I areas are also shown.	3-3

LIST OF TABLES

	Page
Table 2-1: Point Source Parameters and Emission Rates	2-2
Table 2-2: PM ₁₀ Size Distribution	2-3
Table 2-3: PM ₁₀ Speciation and Size Distribution.....	2-4
Table 4-1. Visibility Impacts for 2002	4-2
Table 4-1. Visibility Impacts for 2002 (continued).....	4-3
Table 4-2. Visibility Impacts for 2006.	4-4
Table 4-2. Visibility Impacts for 2006 (continued).....	4-5
Table 4-3. Visibility Impacts for 2007.	4-6
Table 4-3. Visibility Impacts for 2007 (continued).....	4-7

1. INTRODUCTION

TRC Environmental Corporation has conducted a site-specific BART (Best Available Retrofit Technology) modeling assessment of the Big Stone I coal-fired power plant facility located near Milbank and Big Stone City in South Dakota to determine if this facility is subject to BART controls on emissions. Part I of the October 2009 report presented a modeling assessment of baseline emissions from the Big Stone I power plant facility to determine whether the facility is subject to BART controls. This report (Part 2) represents the results of 10 emission control scenarios.

On July 6, 2005 the U.S. Environmental Protection Agency (U.S. EPA) published in the Federal Register the "Regional Haze Regulations and Guidelines for Best Available Retrofit Technology (BART) Determinations" (40 CFR Part 51). The regional haze rule requires States to submit implementation plans (SIPs) to address regional haze visibility impairment in 156 Federally-protected parks and wilderness areas, commonly referred to as "Class 1 Areas". The final rule addresses BART-eligible sources, which are defined as sources that have the potential to emit 250 tons or more of a visibility-impairing air pollutant, were put in place between August 7, 1962 and August 7, 1977 and whose operations fall within one or more of 26 specifically listed source categories, of which Coal-Fired Power Plants are one.

The modeling described in this report is consistent with modeling described in baseline report. All CALMET/CALPUFF switches used in this BART analysis are identical with the switches used and described in previous report. In this report, ten BART control scenarios were analyzed and results of these modeling presented.

The purpose of the modeling is to assess the visibility impacts of sulfur dioxide (SO₂), particulate matter (PM) and nitrogen oxides (NO_x) emissions from the Big Stone I boiler and compare the impacts to the 0.5 change in deciview threshold at all the federally mandatory Class I areas. Since there is no Class I area within the 300 km radius usually applied, the South Dakota Department of Environment and Natural Resources requested that the Class I areas between 300 km and up to 625 km away from the Big Stone I facility sources be modeled. A total of eight Class I areas are located between these distances: two wilderness areas: Boundary Waters Canoe Area Wilderness and Rainbow Lake Wilderness, one National Wildlife Refuge (NWR): Lostwood and five National Parks: Voyageurs NP, Theodore Roosevelt NP, Badlands NP, Wind Cave NP and Isle Royale NP. However, Rainbow Lake Wilderness is one of two Class I areas where the visibility analysis is not required (<http://www.dnr.state.wi.us/org/aw/air/modeling/psd.htm>), so it is not included in the modeling analysis. The MM5 datasets distributed by WRAP did not extend far enough in the East to include the Isle Royale NP or cover all of the Boundary Waters Class I area. The re-extracted MM5 data for 2002 and new MM5 domains for 2006 and 2007 include these areas.

The CALMET and CALPUFF non-steady-state models (Scire et al., 2000a,b) are recommended by the U.S. EPA (*Federal Register*, 6 July 2005) to perform source-specific subject-to-BART

screening. The CALPUFF system was therefore used for this modeling analysis. The U.S. EPA has promulgated the CALPUFF modeling system as a *Guideline Model* for Class I impact assessments and other long range transport applications or near field applications involving complex flows (U.S. EPA, 2000), and the model is recommended by both the Federal Land Managers (FLM) Air Quality Workgroup (FLAG, 2000) and the Interagency Workgroup on Air Quality Modeling (IWAQM, 1998). The CALPUFF modeling system is also recommended in new proposed guidance by the FLMs (FLAG, 2008). On August 31, 2009 EPA issued new recommendations on CALMET switch settings. The current modeling is based on the August 2009 recommendations.

The Big Stone I BART modeling analysis was performed with the EPA-approved Version 5.8 of the CALMET and CALPUFF models. Version 6.221 of CALPOST was used because it contains the FLM-approved implementation of Method 8 (FLAG, 2008), but in other respects is identical to the EPA-approved Version 5.6394.

CALMET is a diagnostic meteorological model that produces three-dimensional wind fields based on parameterized treatments of terrain effects such as slope flows and terrain blocking effects. Normally, meteorological observations are blended with gridded data from the NCAR-PSU Mesoscale Model, Version 5 (MM5). For this evaluation, MM5 data were generated by TRC with a 12-km grid spacing for two years (2006 and 2007) to define the initial guess wind fields. For 2002, 12-km MM5 data were re-extracted from the EPA MM5 dataset to cover entire region including the Isle Royale NP to the east.

CALPUFF is a non-steady-state puff dispersion model. It accounts for spatial changes in the CALMET-produced meteorological fields, variability in surface conditions (elevation, surface roughness, vegetation type, etc.), chemical transformation, wet removal due to rain and snow, dry deposition, and terrain influences on plume interaction with the surface. CALPUFF contains a module to compute visibility effects, based on a humidity-dependent relationship between particulate matter concentrations and light extinction, as well as wet and dry acid deposition fluxes. The meteorological and dispersion modeling simulations were conducted for three years (2002, 2006 and 2007). SO₂, SO₄, PM, and NO_x, emissions and their secondary products resulting from chemical conversions from the Big Stone I facility were modeled and their impacts on visibility evaluated at receptors in the Class I areas. Visibility impacts were estimated with the new FLM-recommended visibility algorithm and monthly average relative humidity adjustment factors (Method 8 in Version 6.221).

This report outlines the techniques and data sources used in the BART analyses. In Section 2, a general description of the source configurations for the baseline case and 10 control scenarios are provided. Section 3 refers to the baseline report where descriptions of the site characteristics and data bases (meteorological, geophysical, and aerometric) were provided, as well as an overview of the CALMET and CALPUFF models settings and parameters that were used in the analysis. The results of the control scenario evaluations are summarized in Section 4.

2. SOURCE DESCRIPTION

The 450-megawatt Big Stone I facility is a coal-fired power plant situated close to Big Stone City and Milbank in Grant County, South Dakota, at the border of Minnesota State. A BART applicability analysis was completed for the facility to determine those sources subject to the BART controls. The BART-eligible source is the Big Stone I cyclone-fired boiler with one stack 152 meters (498 feet) high.

The proposed emissions for the BART analysis were described in a Modeling Protocol dated June 2009. These emissions were reviewed and approved by SD DENR. In addition, 10 different control scenarios were modeled. Table 2-1 shows the source parameters and emission rates for the source considered in this report both for the baseline case and ten control scenarios. The highest 24-hour average actual emission rates of SO₂, NO_x and PM under normal conditions over the 2001-2003 period were used for the baseline case in this analysis.

As shown in Table 2-2, the filterable PM₁₀ are divided into a particle size distribution based on AP-42, Table 1.1-6 for baghouse controlled emissions because the facility currently uses a fabric filter for PM control. Approximately 57.6% of the filterable mass is in the fine (PM_{2.5}) size category, and 42.4% in the coarse (2.5 to 10 μm diameter) size range. Each of the particle size categories was modeled as a separate PM species in CALPUFF. The filterable PM₁₀ emission rate is reported by the facility at 10.48 g/s (83.2 lb/hr). Based on AP-42 Table 1.1-5, the total condensable PM₁₀ is approximately 0.01 lb/mmBtu based on approximately 0.4% sulfur coal or 7.07 g/sec (56.1 lb/hr) assuming an heat input of 5609 mmBtu/hr. This estimate is consistent with the stack test data (August, 2006) at Otter Tail Power's Hoot Lake Plant, Unit 2, (which burns PRB coal) where the ratio of the filterable/total PM₁₀ ratio was 0.66, resulting in a 2/3 filterable and 1/3 condensable split to the total PM₁₀.¹

Elemental Carbon (EC) emissions were assumed to be 3.7% of the fine filterable fraction based on U.S. EPA (2002) and were assigned to the smallest particle size category. The primary H₂SO₄ emissions are 0.454 g/s (3.604 lb/hr) based on annual emission inventories and Toxic Release Inventory reports. The remaining condensable emissions were assigned to organic carbon and distributed equally into the two smallest particle size categories.

Table 2-3 provides a summary of the PM₁₀ speciation and size distribution.

Note that since all Class I areas are more than 50 km away from the facility, as recommended by the Federal Land Managers (FLMs) (US Fish and Wildlife, National Park Service and U.S. Forest Service), no downwash computations was performed.

¹ AP-42 Table 1.1-8 was not used to estimate the particulate matter size distribution for Big Stone I because the emission factors were derived for cyclones burning bituminous coal, not sub-bituminous coal which is burned at Big Stone I.

Table 2-1: Point Source Parameters and Emission Rates

Main Stack	LCC ¹ East (km)	LCC ¹ North (km)	Stack Ht (m)	Base Elevation (m)	Stack Diameter (m)	Exit Velocity (m/s)	Exit Temp. (K) ²	SO ₂ Emission Rate (g/s)	H ₂ SO ₄ Emission Rate (g/s)	NO _x Emission Rate (g/s)	Filterable PM ₁₀ ² Emission Rate (g/s)	Condensable PM ₁₀ Emission Rate (g/s)
Baseline Case	38.141	587.875	151.79	328.90	7.37	20.14	423.1	608.9	0.454	611.7	10.48	7.07
Control 1 Over-fire Air (OFA) Presumptive Dry FGD	"	"	"	"	"	19.57	352.6	106.0	"	459.4	"	"
Control 2 OFA Presumptive Wet FGD	"	"	"	"	"	18.23	330.4	106.0	"	459.4	"	"
Control 3 OFA Dry FGD at 90% Control	"	"	"	"	"	19.57	352.6	63.6	"	459.4	"	"
Control 4 OFA Wet FGD at 95% Control	"	"	"	"	"	18.23	330.4	30.4	"	459.4	"	"
Control 5 Separated OFA (SOFA) Presumptive Dry FGD	"	"	"	"	"	19.57	352.6	106.0	"	353.4	"	"
Control 5a SOFA Dry FGD at 90% Control	"	"	"	"	"	19.57	352.6	63.6	"	353.4	"	"
Control 5b SOFA Wet FGD at 95% Control	"	"	"	"	"	18.23	330.4	30.4	"	353.4	"	"
Control 6 SNCR with SOFA, Presumptive Dry FGD	"	"	"	"	"	19.57	352.6	106.0	"	247.4	"	"
Control 7 RRI+SNCR with SOFA Presumptive Dry FGD	"	"	"	"	"	19.57	352.6	106.0	"	141.3	"	"
Control 8 SCR with SOFA Presumptive Dry FGD	"	"	"	"	"	19.57	352.6	106.0	"	70.7	"	"

¹ Lambert Conformal Projection with an origin of 40.0N, 97.0W and standard parallels at 33N and 45N. Datum is NWS-84.

² The PM technology for all modeling scenarios is the existing pulse-jet fabric filter.

Table 2-2: PM₁₀ Size Distribution¹

Particle Size ² (μm)	Cumulative Mass (PM) (%)	Cumulative Mass (PM ₁₀) (%)
15	97	-
10	92	100
6	77	83.7
2.5	53	57.6
1.25	31	33.7
1.00	25	27.2

- ¹ From AP-42, Table 1.1-6, Cumulative particle size distribution and size-specific emission factors for dry bottom boilers burning pulverized bituminous and subbituminous coal.
- ² Expressed as aerodynamic equivalent diameter.

Table 2-3: PM₁₀ Speciation and Size Distribution

input Data:								H ₂ SO ₄ g/s	PM ₁₀ g/s	g/s			
PM ₁₀ and H ₂ SO ₄ Emissions (g/s)								0.454	17.550				
condensable %											filterable 59.7%	condensable 40.3%	
											g/s	g/s	
											10.480	7.070	
												non H₂SO₄ condensable g/s	
												6.616	
	AP-42, Table 1.1-6												
	coarse	coarse	soil	soil	soil	soil	EC	H ₂ SO ₄	OC	OC	IC (soil)	IC (soil)	
	PM800	PM425	PM187	PM112	PM081	PM056	PM056		PM081	PM056	PM081	PM056	
	6.00 - 10.00	2.50-6.00	1.25- 2.50	1.00- 1.25	0.625-1.00	0.50- 0.625	0.50-0.625		0.625- 1.00	0.50- 0.625	0.625- 1.00	0.50- 0.625	
	16.3%	26.1%	23.9%	6.5%	12.0%	15.2%	57.6%		50.0%	50.0%	50.0%	50.0%	
EC % of filterable							96.3%		100%			0%	
inorganic % of condensable	g/s	g/s	g/s	g/s	g/s	g/s	g/s	g/s	g/s	g/s			
	1.708	2.735	2.412	0.656	1.211	1.534	0.223	0.454	3.308	3.308			
	inputs to POSTUTIL:												
Extinction coefficient	0.6	0.6	1	1	1	1	10	3*f(RH)	4	4			
	coarse	coarse	soil	soil	soil	soil	EC	H ₂ SO ₄	OC	OC			
	PM800	PM425	PM187	PM112	PM081	PM056	PM056		PM081	PM056			
	g/s	g/s	g/s	g/s	g/s	g/s	g/s	g/s	g/s	g/s			
	1.708	2.735	2.412	0.656	1.211	1.534	0.223	0.454	3.308	3.308			

3. GEOPHYSICAL AND METEOROLOGICAL DATA, AIR QUALITY MODELING OPTIONS

The South Dakota Department of Environment and Natural Resources requested that the eight Class I areas shown in Figure 3-1 be considered in the BART analysis. Rainbow Lake Wilderness is one of two Class I areas where the visibility analysis is not required so it has been removed from the present analysis (see <http://www.dnr.state.wi.us/org/aw/air/modeling/psd.htm>). The MM5 dataset for this analysis were extended to include the Isle Royale National Park as well as all of the Boundary Waters Class I area.

Processing of the topography and land use for the domain shown in Figure 3-1 was described in detail in Section 3 of the October 2009 Big Stone Report (Report). In the same Report, all meteorological data and ozone data used in the modeling have been discussed. Locations of the stations were presented in Figures 3-3 and 3-4 of the Report.

CALMET was run with 4-km grid resolution using 12-km MM5 data for initial guess fields. CALMET and CALPUFF use terrain-following coordinates. In order to cover a large enough area for the refined analysis covering all seven Class I areas within a single domain, and including a buffer of at least 50 km around each Class I area, the domain dimensions of 1250 km x 720 km were used. For a 4-km grid spacing, this amounts to 313 x 181 grid cells. In the vertical, a stretched grid was used with finer resolution in the lower layers and somewhat coarser resolution aloft thus allowing adequate representation of the mixed layer. The ten vertical levels were centered at: 10, 30, 60, 120, 240, 480, 920, 1600, 2500 and 3500 meters.

CALMET and CALPUFF were run for three years, 2002, 2006 and 2007. A network of discrete receptors derived from the list of receptors developed by the National Park Service (NPS) are located within the boundaries of the seven Class I areas modeled: Boundary Water Canoe Area Wilderness, Voyageur National Park, Badlands National Park, Wind Cave National Park, Lostwood National Wildlife Refuge, Theodore Roosevelt National Park and Isle Royale National Park.

Meteorological modeling options including initial guess fields and step 1 and 2 wind fields, dispersion modeling options and visibility calculations were all described in Section 4 of the October 2009 report.

Calculations of the impact of the simulated plume particulate matter component concentrations on light extinction were carried out with the CALPOST postprocessor following the new proposed FLAG (2008) guidance. A revised new IMPROVE algorithm to compute the extinction (1/Mm) has been developed by the IMPROVE steering committee for estimating light extinction from particulate matter. That algorithm provides a better correspondence between the measured visibility and that calculated from particulate matter component concentrations (Tombach, 2006):

To represent background natural conditions, monthly background concentrations must be entered into the CALPOST input control file for all aerosols defining the background. The WRAP Protocol (2006) recommendations for natural conditions background are to use all three types of EPA default Natural Conditions: Best 20% Days, Annual Average and Worst 20% Days. In "Guidance for Estimating Visibility Conditions Under the Regional Haze Rule" (EPA, 2003), these three default values are defined only by their extinction coefficient in Mm^{-1} . For CALPOST Method 8, explicit background

concentrations are required to allow the computation of the small and large sulfate particulates, nitrate particulates and organic carbon. So, in this analysis, the annual averaged background conditions were used to define the natural background for each of the seven Class I areas, following FLAG (2008). The concentrations used as background for each of the seven Class I areas are summarized in Table 4-2 of the October 2009 report. These concentrations were used to compute the natural background light extinction following the revised IMPROVE formulae described above, for each of the Class I areas.

Tables 4-3, 4-4, and 4-5 in October 2009 report, provide the monthly $f(RH)$ values for each of the seven Class I areas, that are used to compute extinction coefficients for hygroscopic species, respectively for small ammonium sulfate and ammonium nitrate particles, large ammonium sulfate and ammonium nitrate particles, and sea salt particles.

The 8th highest (98th percentile) predicted light extinction change for each year modeled was compared to the threshold value of 0.5 deciview.

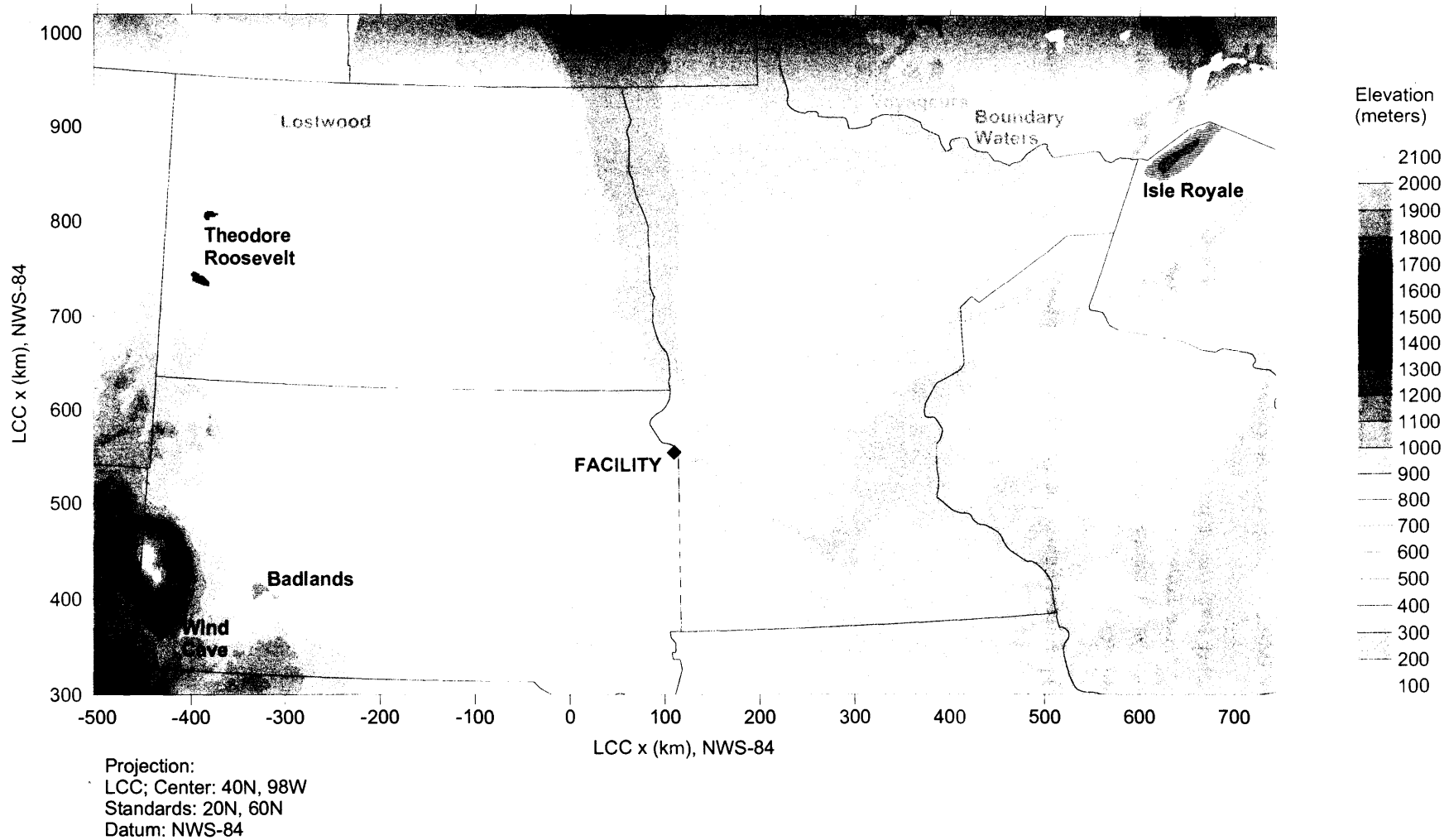

Figure 3-1. Terrain elevations for the CALMET and CALPUFF modeling domain at 4 km resolution. The locations of the Big Stone facility and Class I areas are also shown.

4. RESULTS

The results for the BART analysis for the Big Stone I facility are presented in this section. The analysis consists of evaluating the visibility impact (percent change in light extinction due to the sources measured in deciview) at all the Class I areas modeled. The results are presented in three tables for the baseline case and ten control scenarios, each table gathering the impact at seven Class I areas for each of the years modeled: Table 4-1 for 2002, Table 4-2 for 2006 and Table 4-3 for 2007. The change in light extinction due to the source is compared to the annual average natural background light extinction. The interpretation of the results is done by comparing the 98th percentile of delta deciview for each year to the 0.5 delta deciview threshold. Analysis is performed by using CALPOST Method 8.

Table 4-1. Visibility Impacts for 2002

	Park	Max Delta Deciview	4th Highest (99%)	8th Highest (98%)	Nb. Exceed. > 5%	Nb. Exceed. > 10%
Baseline	Boundary Waters	1.315	0.837	0.574	14	1
	Voyageurs	2.162	0.690	0.623	9	3
	Wind Cave	0.873	0.475	0.305	3	0
	Theodore Roosevelt	1.390	0.555	0.215	4	1
	Lostwood	0.564	0.388	0.232	2	0
	Badlands	0.762	0.671	0.452	7	0
	Isle Royale	1.182	0.789	0.629	10	2
Control 1	Boundary Waters	0.685	0.563	0.330	5	0
	Voyageurs	1.252	0.541	0.329	4	1
	Wind Cave	0.485	0.258	0.101	0	0
	Theodore Roosevelt	0.530	0.298	0.092	1	0
	Lostwood	0.329	0.171	0.111	0	0
	Badlands	0.462	0.342	0.223	0	0
	Isle Royale	0.780	0.471	0.377	2	0
Control 2	Boundary Waters	0.716	0.639	0.360	5	0
	Voyageurs	1.191	0.586	0.349	5	1
	Wind Cave	0.417	0.262	0.095	0	0
	Theodore Roosevelt	0.476	0.278	0.099	0	0
	Lostwood	0.320	0.155	0.118	0	0
	Badlands	0.549	0.315	0.234	1	0
	Isle Royale	0.809	0.497	0.367	3	0
Control 3	Boundary Waters	0.647	0.542	0.319	5	0
	Voyageurs	1.210	0.534	0.307	4	1
	Wind Cave	0.473	0.244	0.093	0	0
	Theodore Roosevelt	0.453	0.287	0.087	0	0
	Lostwood	0.317	0.150	0.109	0	0
	Badlands	0.441	0.326	0.219	0	0
	Isle Royale	0.758	0.448	0.363	2	0
Control 4	Boundary Waters	0.687	0.593	0.350	5	0
	Voyageurs	1.121	0.574	0.312	4	1
	Wind Cave	0.379	0.237	0.080	0	0
	Theodore Roosevelt	0.421	0.260	0.084	0	0
	Lostwood	0.298	0.138	0.103	0	0
	Badlands	0.505	0.281	0.225	1	0
	Isle Royale	0.762	0.456	0.351	2	0

Table 4-1. Visibility Impacts for 2002 (continued).

	Park	Max Delta Deciview	4th Highest (99%)	8th Highest (98%)	Nb. Exceed. > 5%	Nb. Exceed. > 10%
Control 5	Boundary Waters	0.551	0.449	0.264	2	0
	Voyageurs	0.997	0.426	0.263	3	0
	Wind Cave	0.385	0.206	0.083	0	0
	Theodore Roosevelt	0.458	0.237	0.076	0	0
	Lostwood	0.263	0.144	0.089	0	0
	Badlands	0.370	0.272	0.169	0	0
	Isle Royale	0.618	0.375	0.298	2	0
Control 5a	Boundary Waters	0.513	0.428	0.250	2	0
	Voyageurs	0.955	0.419	0.249	3	0
	Wind Cave	0.372	0.191	0.074	0	0
	Theodore Roosevelt	0.380	0.227	0.069	0	0
	Lostwood	0.251	0.124	0.085	0	0
	Badlands	0.349	0.256	0.165	0	0
	Isle Royale	0.595	0.355	0.285	2	0
Control 5b	Boundary Waters	0.537	0.465	0.274	2	0
	Voyageurs	0.876	0.449	0.244	2	0
	Wind Cave	0.296	0.184	0.063	0	0
	Theodore Roosevelt	0.325	0.204	0.066	0	0
	Lostwood	0.234	0.109	0.081	0	0
	Badlands	0.396	0.219	0.174	0	0
	Isle Royale	0.594	0.357	0.274	2	0
Control 6	Boundary Waters	0.418	0.335	0.200	0	0
	Voyageurs	0.740	0.309	0.196	2	0
	Wind Cave	0.283	0.154	0.072	0	0
	Theodore Roosevelt	0.384	0.176	0.063	0	0
	Lostwood	0.196	0.118	0.075	0	0
	Badlands	0.278	0.203	0.120	0	0
	Isle Royale	0.464	0.275	0.221	0	0
Control 7	Boundary Waters	0.285	0.221	0.137	0	0
	Voyageurs	0.481	0.192	0.130	0	0
	Wind Cave	0.180	0.104	0.070	0	0
	Theodore Roosevelt	0.309	0.115	0.050	0	0
	Lostwood	0.129	0.085	0.051	0	0
	Badlands	0.187	0.135	0.090	0	0
	Isle Royale	0.310	0.174	0.142	0	0
Control 8	Boundary Waters	0.198	0.143	0.097	0	0
	Voyageurs	0.309	0.125	0.086	0	0
	Wind Cave	0.119	0.072	0.053	0	0
	Theodore Roosevelt	0.262	0.074	0.036	0	0
	Lostwood	0.085	0.053	0.037	0	0
	Badlands	0.127	0.102	0.079	0	0
	Isle Royale	0.207	0.113	0.092	0	0

Table 4-2. Visibility Impacts for 2006.

	Park	Max Delta Deciview	4th Highest (99%)	8th Highest (98%)	Nb. Exceed. > 5%	Nb. Exceed. > 10%
Baseline	Boundary Waters	2.572	1.183	0.790	16	5
	Voyageurs	1.578	0.862	0.574	11	2
	Wind Cave	0.454	0.302	0.120	0	0
	Theodore Roosevelt	2.232	0.772	0.459	6	3
	Lostwood	1.110	0.662	0.385	5	1
	Badlands	1.002	0.519	0.481	7	1
	Isle Royale	1.806	0.635	0.506	8	2
Control 1	Boundary Waters	1.375	0.799	0.548	9	3
	Voyageurs	1.262	0.554	0.399	5	1
	Wind Cave	0.273	0.162	0.024	0	0
	Theodore Roosevelt	1.234	0.469	0.247	3	1
	Lostwood	0.619	0.355	0.168	2	0
	Badlands	0.504	0.319	0.176	1	0
	Isle Royale	1.010	0.467	0.296	2	1
Control 2	Boundary Waters	1.405	0.830	0.546	11	3
	Voyageurs	1.549	0.594	0.494	7	2
	Wind Cave	0.266	0.162	0.027	0	0
	Theodore Roosevelt	1.116	0.454	0.244	3	1
	Lostwood	0.588	0.366	0.171	3	0
	Badlands	0.482	0.326	0.199	0	0
	Isle Royale	1.014	0.462	0.273	3	1
Control 3	Boundary Waters	1.319	0.780	0.534	8	3
	Voyageurs	1.218	0.540	0.391	5	1
	Wind Cave	0.260	0.150	0.023	0	0
	Theodore Roosevelt	1.196	0.455	0.234	3	1
	Lostwood	0.594	0.339	0.153	2	0
	Badlands	0.482	0.308	0.172	0	0
	Isle Royale	0.983	0.454	0.287	2	0
Control 4	Boundary Waters	1.313	0.793	0.521	10	3
	Voyageurs	1.469	0.571	0.464	6	1
	Wind Cave	0.244	0.139	0.025	0	0
	Theodore Roosevelt	1.052	0.431	0.230	3	1
	Lostwood	0.554	0.335	0.144	2	0
	Badlands	0.443	0.306	0.191	0	0
	Isle Royale	0.966	0.440	0.250	3	0

Table 4-2. Visibility Impacts for 2006 (continued).

	Park	Max Delta Deciview	4th Highest (99%)	8th Highest (98%)	Nb. Exceed. > 5%	Nb. Exceed. > 10%
Control 5	Boundary Waters	1.109	0.635	0.433	6	2
	Voyageurs	1.013	0.440	0.314	2	1
	Wind Cave	0.216	0.132	0.019	0	0
	Theodore Roosevelt	0.987	0.372	0.199	2	0
	Lostwood	0.494	0.281	0.136	0	0
	Badlands	0.401	0.252	0.137	0	0
	Isle Royale	0.804	0.366	0.235	2	0
Control 5a	Boundary Waters	1.051	0.615	0.419	6	2
	Voyageurs	0.967	0.426	0.306	2	0
	Wind Cave	0.204	0.120	0.018	0	0
	Theodore Roosevelt	0.948	0.358	0.186	2	0
	Lostwood	0.468	0.265	0.124	0	0
	Badlands	0.378	0.242	0.133	0	0
	Isle Royale	0.777	0.355	0.226	2	0
Control 5b	Boundary Waters	1.036	0.622	0.407	6	2
	Voyageurs	1.160	0.449	0.365	3	1
	Wind Cave	0.189	0.109	0.019	0	0
	Theodore Roosevelt	0.827	0.336	0.180	2	0
	Lostwood	0.430	0.259	0.114	0	0
	Badlands	0.344	0.237	0.147	0	0
	Isle Royale	0.758	0.342	0.195	1	0
Control 6	Boundary Waters	0.837	0.468	0.318	3	0
	Voyageurs	0.759	0.325	0.228	2	0
	Wind Cave	0.161	0.103	0.016	0	0
	Theodore Roosevelt	0.736	0.274	0.150	1	0
	Lostwood	0.369	0.209	0.103	0	0
	Badlands	0.297	0.186	0.098	0	0
	Isle Royale	0.595	0.268	0.174	1	0
Control 7	Boundary Waters	0.560	0.299	0.202	1	0
	Voyageurs	0.502	0.204	0.157	1	0
	Wind Cave	0.107	0.071	0.014	0	0
	Theodore Roosevelt	0.479	0.176	0.101	0	0
	Lostwood	0.244	0.138	0.082	0	0
	Badlands	0.227	0.120	0.066	0	0
	Isle Royale	0.382	0.169	0.115	0	0
Control 8	Boundary Waters	0.373	0.186	0.136	0	0
	Voyageurs	0.328	0.128	0.107	0	0
	Wind Cave	0.071	0.047	0.012	0	0
	Theodore Roosevelt	0.306	0.111	0.070	0	0
	Lostwood	0.162	0.092	0.064	0	0
	Badlands	0.188	0.079	0.060	0	0
	Isle Royale	0.239	0.104	0.077	0	0

Table 4-3. Visibility Impacts for 2007.

	Park	Max Delta Deciview	4th Highest (99%)	8th Highest (98%)	Nb. Exceed. > 5%	Nb. Exceed. > 10%
Baseline	Boundary Waters	3.574	1.351	1.079	25	9
	Voyageurs	2.062	1.376	0.724	19	5
	Wind Cave	1.671	0.591	0.325	4	2
	Theodore Roosevelt	0.744	0.491	0.322	3	0
	Lostwood	0.959	0.722	0.409	6	0
	Badlands	2.202	0.698	0.471	6	2
	Isle Royale	1.224	0.745	0.665	13	2
Control 1	Boundary Waters	2.018	0.874	0.657	9	2
	Voyageurs	1.260	0.750	0.460	7	2
	Wind Cave	0.950	0.334	0.130	3	0
	Theodore Roosevelt	0.393	0.211	0.190	0	0
	Lostwood	0.547	0.415	0.245	1	0
	Badlands	1.292	0.395	0.241	3	1
	Isle Royale	0.665	0.436	0.339	2	0
Control 2	Boundary Waters	1.959	0.890	0.667	11	2
	Voyageurs	1.232	0.768	0.521	8	2
	Wind Cave	1.030	0.355	0.130	2	1
	Theodore Roosevelt	0.395	0.228	0.161	0	0
	Lostwood	0.558	0.426	0.253	2	0
	Badlands	1.369	0.440	0.254	2	1
	Isle Royale	0.720	0.439	0.323	2	0
Control 3	Boundary Waters	1.944	0.848	0.620	9	1
	Voyageurs	1.225	0.717	0.450	7	1
	Wind Cave	0.902	0.317	0.120	2	0
	Theodore Roosevelt	0.380	0.204	0.173	0	0
	Lostwood	0.520	0.394	0.226	1	0
	Badlands	1.234	0.378	0.230	2	1
	Isle Royale	0.641	0.418	0.323	2	0
Control 4	Boundary Waters	1.844	0.840	0.611	10	1
	Voyageurs	1.171	0.705	0.502	8	1
	Wind Cave	0.938	0.323	0.117	2	0
	Theodore Roosevelt	0.373	0.197	0.138	0	0
	Lostwood	0.509	0.381	0.234	1	0
	Badlands	1.261	0.405	0.234	2	1
	Isle Royale	0.677	0.406	0.290	2	0

Table 4-3. Visibility Impacts for 2007 (continued).

	Park	Max Delta Deciview	4th Highest (99%)	8th Highest (98%)	Nb. Exceed. > 5%	Nb. Exceed. > 10%
Control 5	Boundary Waters	1.630	0.699	0.524	8	1
	Voyageurs	0.997	0.602	0.364	4	0
	Wind Cave	0.763	0.268	0.106	1	0
	Theodore Roosevelt	0.311	0.175	0.156	0	0
	Lostwood	0.439	0.328	0.211	0	0
	Badlands	1.039	0.315	0.191	2	1
	Isle Royale	0.525	0.349	0.272	2	0
Control 5a	Boundary Waters	1.554	0.671	0.493	6	1
	Voyageurs	0.961	0.569	0.354	4	0
	Wind Cave	0.715	0.251	0.096	1	0
	Theodore Roosevelt	0.299	0.160	0.141	0	0
	Lostwood	0.412	0.314	0.178	0	0
	Badlands	0.979	0.298	0.180	2	0
	Isle Royale	0.503	0.331	0.256	1	0
Control 5b	Boundary Waters	1.459	0.667	0.478	6	1
	Voyageurs	0.915	0.554	0.393	6	0
	Wind Cave	0.735	0.253	0.091	1	0
	Theodore Roosevelt	0.291	0.155	0.108	0	0
	Lostwood	0.399	0.301	0.182	0	0
	Badlands	0.991	0.316	0.182	2	0
	Isle Royale	0.527	0.319	0.227	1	0
Control 6	Boundary Waters	1.233	0.520	0.388	4	1
	Voyageurs	0.737	0.454	0.267	3	0
	Wind Cave	0.575	0.202	0.085	1	0
	Theodore Roosevelt	0.230	0.143	0.121	0	0
	Lostwood	0.331	0.241	0.157	0	0
	Badlands	0.781	0.236	0.143	1	0
	Isle Royale	0.388	0.259	0.199	0	0
Control 7	Boundary Waters	0.825	0.339	0.256	2	0
	Voyageurs	0.501	0.304	0.176	1	0
	Wind Cave	0.389	0.137	0.071	0	0
	Theodore Roosevelt	0.149	0.112	0.080	0	0
	Lostwood	0.223	0.155	0.101	0	0
	Badlands	0.524	0.157	0.099	1	0
	Isle Royale	0.268	0.172	0.134	0	0
Control 8	Boundary Waters	0.549	0.217	0.170	1	0
	Voyageurs	0.383	0.205	0.123	0	0
	Wind Cave	0.265	0.093	0.055	0	0
	Theodore Roosevelt	0.102	0.090	0.064	0	0
	Lostwood	0.152	0.122	0.063	0	0
	Badlands	0.352	0.105	0.070	0	0
	Isle Royale	0.189	0.124	0.098	0	0

5. REFERENCES

- FLAG, 2000. Federal Land Manager' Air Quality Related Values Workgroup (FLAG). Phase I Report. U.S. Forest Service, National Park Service, U.S. Fish and Wildlife Service.
- FLAG, 2008. Federal Land Manager' Air Quality Related Values Workgroup (FLAG). Phase I Report -Revised. U.S. Forest Service, National Park Service, U.S. Fish and Wildlife Service, *June 27, 2008, Draft*.
- Scire, J.S., D.G. Strimaitis, and R.J. Yamartino, 2000a: A User's Guide for the CALPUFF Dispersion Model (Version 5). Earth Tech, Inc., Concord, MA
- Scire, J.S., F.R. Robe, M.E. Fernau, and R.J. Yamartino, 2000b: A User's Guide for the CALMET Meteorological Model (Version 5). Earth Tech, Inc., Concord, MA.
- Tombach, I, 2006: Instructions: A Postprocessor for Recalculating CALPOST Visibility Outputs with the New IMPROVE Algorithm, Version 2, 14 October, 2006.
- U.S. EPA, 1998: Interagency Workgroup on Air Quality Modeling (IWAQM), Phase 2 Report: Summary Report and Recommendation for Modeling Long Range Transport and Impacts on Regional Visibility. EPA-454/R-98-019.
- U.S. EPA, 2000: Federal Register Notice dated April 21, 2001.
- U.S. EPA, 2003: Guidance for Estimating Natural Visibility Conditions Under the Regional Haze Program. EPA-454/B-03-005, September 2003.
- U. S. EPA, 2005: Regional Haze Regulations and Guidelines for Best Available Technology (BART) Determinations. Fed. Reg./Vol. 70, No. 128/Wed. July 6, 2005, Rules and Regulations, pp. 39104-39172. 40 CFR Part 51, FRL-7925-9, RIN AJ31.
- U.S. EPA, 2009: Clarification on EPA-FLM Recommended Settings for CALMET. EPA Memo by T. Fox dated August 31, 2009.
- WRAP Air Quality Modeling Forum RMC, 2006: CALMET/CALPUFF Protocol for the BART Exemption Screening Analysis for Class I Areas in the Western United States, August 15, 2006.

APPENDIX B
Technical Description of SO₂ Controls (B1)

B1 Technical Description of SO₂ Controls

B1.1 Fuel Switching

Fuel switching can be a viable method of fuel sulfur content reduction in certain situations. The PRB burned by BSP Unit I is one of the lower sulfur coals available in the U.S. and switching to a lower sulfur coal (if available) would achieve little to no additional reduction in SO₂ emissions. Therefore, for the purpose of this BART analysis, fuel switching is not considered a viable option for SO₂ control.

B1.2 Wet Flue Gas Desulfurization

Wet FGD technology utilizing lime or limestone as the reagent and employing forced oxidation to produce gypsum (calcium sulfate dihydrate, CaSO₄·2H₂O) as the byproduct, is commonly applied to coal-fired boilers. The gypsum byproduct is either landfilled or sold for commercial reuse.

A flow diagram of the wet FGD process is provided in Figure B-1. In the wet FGD process, a slurry of finely ground limestone (CaCO₃) in water is recirculated through an absorber tower where it is brought into turbulent contact with the flue gas. The contact between the flue gas and the slurry cools and saturates the gas via evaporation of water from the slurry. SO₂ is simultaneously absorbed into the slurry where it forms sulfurous acid which reacts with the limestone, forming calcium sulfite hemihydrate (CaSO₃·½H₂O) which can then be disposed of as a waste product or oxidized to calcium sulfate dihydrate or gypsum (CaSO₄·2H₂O) before disposal or for commercial reuse. No commercial uses for sulfite waste products have been identified.

Figure B-1. Wet FGD Process Flow Diagram

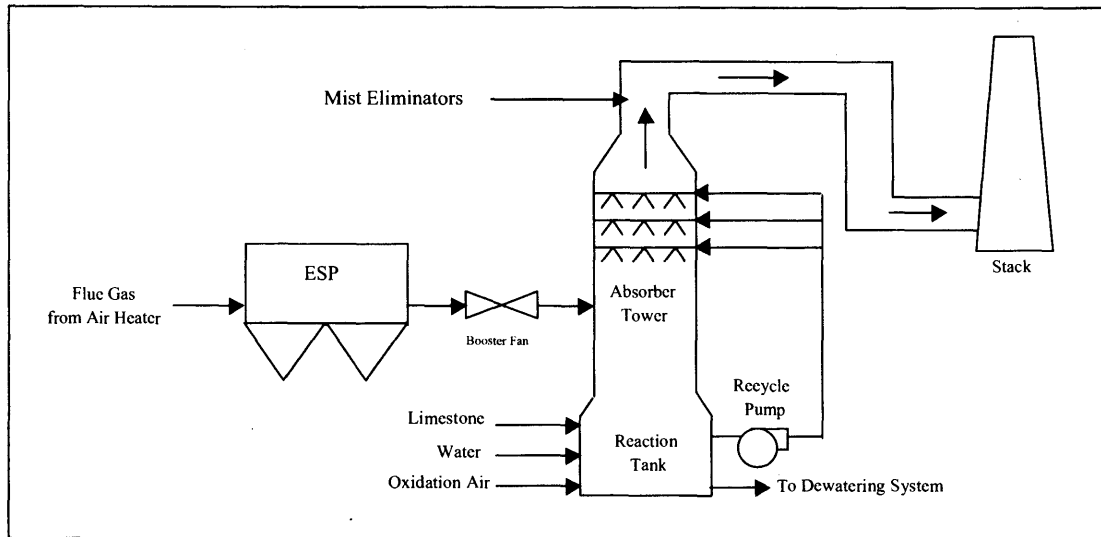

Chemical reactions between the limestone and the absorbed SO_2 take place within the slurry in the absorber, and in the absorber reaction tank, resulting in the formation of particles of $\text{CaSO}_3 \cdot \frac{1}{2} \text{H}_2\text{O}$. Some of the oxygen in the flue gas may participate in the reaction, resulting in the formation of particles of $\text{CaSO}_4 \cdot 2\text{H}_2\text{O}$ as well. Air may be injected into the absorber sump to promote the formation of gypsum and minimize the formation of calcium sulfite solids where a gypsum product is desired, either for ease of disposal or commercial use. The resultant slurry is then processed in a dewatering system prior to disposal or commercial use.

As the limestone reagent in the recirculating slurry is depleted, it is replenished with fresh slurry prepared by wet grinding of crushed limestone using reclaimed liquid from the dewatering system. Fresh water is also required to replace water lost to evaporation in the flue gas cooling process. Fresh water is often used to wash the mist eliminators, devices located at the scrubber exit to capture slurry droplets entrained in the exiting flue gas stream and return them to the scrubber. The mist eliminator wash removes accumulated materials from the mist eliminator chevrons, thus preventing solids buildup and pluggage. In addition, depending upon the mineral content of the coal, a portion of the reclaimed liquid from the dewatering process may be blown down, or disposed of, to prevent excessive accumulation of mineral salts in the slurry which could result in mineral scaling within the absorber equipment. The blow down rate varies with each plant. Fresh water makeup, both through the mist eliminator wash system and in the limestone grinding process, replaces the blow down and evaporative losses.

Lime scrubbers are very similar to limestone scrubbers. The use of lime rather than limestone can reduce the liquid-to-gas ratio and/or absorber size required to achieve a given SO₂ removal rate. Lime is sometimes used in wet FGD systems where extremely high SO₂ removal rates are desired or where limestone is not readily available. However, since lime is more expensive than limestone, the reagent cost is much higher for a lime system. Therefore, the vast majority of wet FGD systems are designed to use limestone as the neutralizing reagent.

Two advantages of the wet FGD systems include lower reagent costs, primarily due to the ability to use limestone instead of lime as a reagent and the production of a salable by-product and high removal efficiency. Also, wet FGD systems have a high turndown capability and plant operational flexibility is not hindered to the same degree as the semi-dry processes. This last advantage is important where wet FGD systems are applied to load following units. Disadvantages of wet FGD systems include corrosion due to a wet environment with corrosive chemicals including salts of sulfurous and sulfuric acid and hydrochloric acid. Also, because the wet systems are more mechanically complex, they typically require larger maintenance staff than the semi-dry, CFB and FDA alternatives. The greater mechanical complexity also contributes to a greater capital cost for wet FGD systems. Finally, because wet FGD systems completely saturate the flue gas stream, nearly all the SO₃ or H₂SO₄ vapor in the entering flue gas is condensed into aerosol droplets which are too small to be efficiently captured in the scrubber. Fifty percent or more of these droplets pass right through the scrubber. Where units are burning high sulfur fuels, this can cause a plume opacity problem. Wet FGD systems commonly achieve 95% percent SO₂ removal efficiencies in commercial applications.

B1.3 Semi-Dry Flue Gas Desulfurization

As an alternative to wet FGD technology, the control of SO₂ emissions can be accomplished using semi-dry FGD technology. The most common semi-dry FGD system is the lime Spray Dryer Absorber (SDA) using a fabric filter for downstream particulate collection. The semi-dry FGD process became popular in the U.S. beginning in the late 1970s as a way to comply with the New Source Performance Standards (NSPS) for electric utility steam generating units for which construction commenced after September 18, 1978 (40 CFR Part 60, Subpart Da). These standards require that all new coal-fired electric utility boilers be equipped with a “continuous system of emission reduction” for SO₂. However, the standards allowed SO₂ removal efficiency as low as 70

percent for facilities burning low-sulfur coal. The semi-dry FGD process could meet this requirement, and was often selected as the SO₂ control technology for many new coal-fired power plants that were built in the 1970s and 1980s and designed to burn low-sulfur western coal. In the late 1980s and through the 1990s, most of the new coal-fired boilers built in the U.S. were for small Independent Power Producer (IPP) projects, and many of these also selected the semi-dry/lime FGD process.

There are several variations of the semi-dry process in use today. This section addresses the spray dryer FGD process. Two other variations, the Novel Integrated Desulfurization and Circulating Fluidized Bed absorber are similar processes. They primarily differ by the type of reactor vessel used, the method in which water and lime are introduced into the reactor and the degree of solids recycling. They are considered similar technologies and are not discussed further.

A schematic diagram of the spray dryer FGD process is provided in Figure B-2. In the spray dryer FGD process, boiler flue gas is introduced into a Spray Dryer Absorber (SDA) into which hydrated lime (calcium hydroxide, Ca(OH)₂) and water are added as dispersed droplets. The Ca(OH)₂ reacts with SO₂ that has been absorbed into the water to form primarily calcium sulfite and some calcium sulfate. The heat from the flue gas causes the water to evaporate, cooling the gas and drying the reaction products. Because the total water feed rate is much lower than that of the wet FGD process, the reaction products are dried in the SDA and the flue gas is only partially saturated. The amount of water added to the process is carefully controlled so that the flue gas temperature is maintained well above the saturation, or dewpoint, temperature (typically 30-40 °F above saturation) to avoid corrosion problems. Cooling the gas to this point significantly increases the SO₂ control efficiency over injection into hot, dry flue gas. The reaction product leaves the SDA as fine dry particles entrained in the flue gas. The flue gas enters the SDA at the top and flows downward, co-current with the introduced neutralizing agent. This characteristic is the opposite of the wet FGD system which introduces flue gas into the bottom of the absorber, countercurrent to the falling slurry spray.

Figure B-2 Spray Dryer FGD Process Flow Diagram

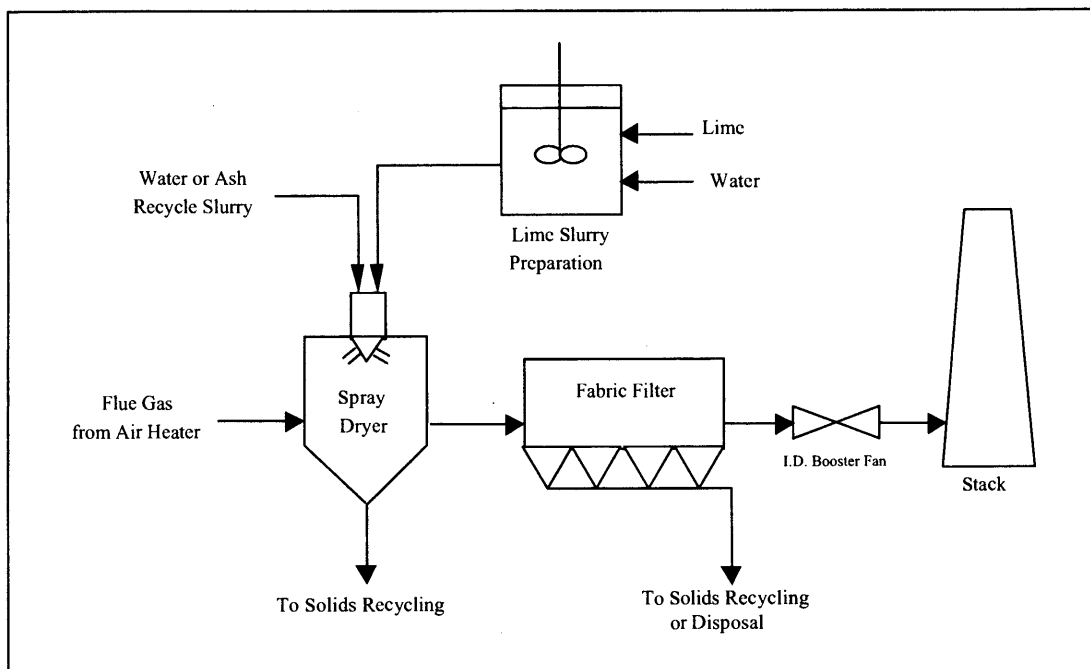

In the lime spray drying process, quicklime (CaO) is slaked with water to form lime slurry which is then injected into the SDA along with additional water through a rotary atomizer or dual fluid nozzle or similar apparatus. Recycled PM from the PM control equipment downstream of the SDA is often mixed with the lime slurry before injection into the SDA to provide additional surface area for SO_2 absorption. The flue gas is introduced into the SDA in a manner designed to maximize the contact between the gas and the droplets and to prevent slurry impingement on the walls of the SDA. The turbulent mixing of the flue gas and the slurry droplets promotes rapid absorption of SO_2 into the water of the slurry droplets. The chemical reactions between the absorbed SO_2 and the calcium hydroxide take place within the droplet as the flue gas moves through the SDA. The flue gas is cooled and partially humidified as the water evaporates, leaving a mixture of fly ash and dry powdered reaction product entrained in the flue gas. Some of the solid particles fall to the bottom of the reactor and are collected by a waste handling system. Entrained particles are collected in an electrostatic precipitator (ESP) or fabric filter (FF) downstream of the SDA.

An additional distinguishing characteristic of the SDA is that it must be located upstream of a particulate control device, as opposed to the wet FGD process which is normally the last flue gas treatment process before discharge to the stack. For new plants, this point is not of such great importance. However, when retrofitting FGD equipment to an existing coal-fired plant, which

already has particulate control equipment installed, this becomes an important point. If a suitable location exists for the insertion of a new SDA upstream of an existing PM control device, and if the performance of the existing PM control device would not be overly degraded by the additional PM loading, then the retrofit process would consist only of installation of the SDA, reagent preparation and waste handling systems. However, many times one, or both, of these conditions do not exist and the choice to utilize an SDA requires the installation of a new PM control device, such as an ESP or fabric filter. Where this situation exists, the capital cost of the SDA option increases significantly.

Semi-dry processes have some notable advantages compared to wet FGD processes including a dry byproduct which can be handled with conventional ash handling systems. Because the semi-dry system does not have a truly wet zone, corrosion problems in the SDA are eliminated, or significantly reduced, to the point exotic materials of construction are not required. Spray dryer systems utilize less complex equipment resulting in a reduced capital cost and allowing somewhat smaller operations and maintenance staff. Where a fabric filter is utilized as the downstream particulate control device for a semi-dry process, the lime content of the filter cake on the fabric filter reacts with condensed SO_3 in the flue gas stream capturing and neutralizing the acid aerosol. Consequently, semi-dry FGD options, paired with a fabric filter for PM control, have virtually zero emissions of acid aerosols.

The primary disadvantages of the lime spray dryer process make it less likely to be applied to large power plant boilers, especially those firing high-sulfur coal. The lime spray dryer requires the use of lime, which is much more expensive than limestone. While lime contains approximately 1.8 times more calcium than limestone on a mass basis, lime can cost up to five times more than limestone on a mass basis. Therefore, reagent costs for a lime based process are typically higher than a limestone-based process for a given application.

Wastes from semi-dry processes have very limited possibility for reuse due to fly ash contamination. Also, where fly ash might be sold for other uses, contamination with the semi-dry FGD reaction products typically eliminates commercial options for reuse. Where fly ash sales are to be maintained, a second PM control device would be required for the semi-dry FGD system exhaust stream, increasing both capital and O&M costs.

SDAs have much more stringent size limitations than wet FGD scrubbers. Typically units larger than 250 to 300 MW will require at least two SDAs, thus driving up capital costs and system complexity for larger units, while wet FGD systems can handle up to 1000 MW in a single absorber module.

SDAs do not have the same turndown capabilities as wet FGD absorbers, further limiting applicability for load following units. Finally, lime spray dryer systems do not have the same level of experience with high SO₂ removal requirements in high sulfur applications that wet FGD systems have.

No variation of semi-dry FGD systems has clearly demonstrated the ability to achieve SO₂ removal levels similar to wet FGD systems in the U.S. Table B-1 lists many of the recent lime spray dryer system installations in the U.S. The information in Table B-1 was obtained from the RACT/BACT/LAER Clearing House. As can be seen in the column titled Efficiency, two units were permitted with an SO₂ removal efficiency of 94.5% and one with 95%. However, these units typically use a lower sulfur fuel and achieve an emissions limit in the range of 0.12 to 0.17 lb SO₂/mmBtu.

Table B-1 – Recent Dry FGD Permits From RBLC

RBLC ID	Facility	Process	Fuel	Size	Unit	Control Device	Emission Limit (lb/mmBtu)	Estimated Efficiency	Permit Date
*NE-0018	Whelan Energy Center	Unit 2 Utility Boiler	PRB coal	2,210	mmBtu/hr	Spray Dryer Absorber (SDA)	0.12	NA	3/30/2004
AR-0074	Plum Point Energy	Boiler, Unit 1 - SN-01	Bituminous Coal	800	MW	Dry Flue Gas Desulfurization	0.16	NA	8/20/2003
MT-0022	Bull Mountain, No. 1, LLC - Roundup Power Project	Boiler, PC No. 1	Coal	390	MW	Dry Flue Gas Desulfurization (FGD)	0.12	94.5	7/21/2003
MT-0022		Boiler, PC No. 2	Coal	390	MW	Dry Flue Gas Desulfurization (FGD)	0.12	94.5	7/21/2003
IA-0067	MidAmerican Energy Company	CBEC 4 Boiler	PRB Coal	7,675	mmBtu/hr	Lime Spray Dryer Flue Gas Desulfurization	0.1	92	6/17/2003
KS-0026	Holcomb Unit #2	Boiler, PC	Subbituminous Coal	660	MW	Dry Flue Gas Desulfurization	0.12	94	10/08/2002
WY-0057	WYGEN 2	500 MW PC Boiler	Subbituminous Coal	500	MW	Semi-Dry Lime Spray Dryer Absorber	0.1	NA	9/25/2002
MO-0050	Kansas City Power & Light Co. - Hawthorn Station	PC Boiler,	Coal	384	T/H	Dry Flue Gas Desulfurization	0.12	NA	8/17/1999
WY-0039	Two Elk Generation Partners, Limited Partnership	PC Fired Boiler	Coal	250	MW	Lime Spray Dry Scrubber	0.17	91	2/27/1998
WY-0047	Encoal Corporation-Encoal North Rochelle Facility	PC Fired Boiler	Subbituminous Coal	3,960	mmBtu/hr	Lime Spray Dryer	0.2	73	10/10/1997
WY-0048	Wygen, Inc. - Wygen Unit One	Boiler, PC	Subbituminous Coal	80	MW	Circulating Dry Scrubber	0.2	92	9/6/1996
PA-0133	Mon Valley Energy Limited Partnership	PC Fired Boiler	Bituminous Coal	966	mmBtu/hr	Spray Dry Absorption	0.25	92	8/8/1995

Table B-1 – Recent Dry FGD Permits From RBLC (cont.)

RBLC ID	Facility	Process	Fuel	Size	Unit	Control Device	Emission Limit (lb/mmBtu)	Estimated Efficiency	Permit Date
VA-0213	SEI Birchwood, Inc.	PC Fired Boiler	Coal	2,200	mmBtu/hr	Lime Spray Drying System (FGD System)	220	94	8/23/1993
WY-0046	Black Hills P&L Neil Simpson U	PC Fired Boiler	Coal	80	MW	Circulating Dry Scrubber	0.17	95	4/14/1993
MI-0228	Indelk Energy Services Of Otsego	Boiler (Coal)	Coal	778	mmBtu/hr	Dry Scrubber	0.32	90	3/16/1993
NC-0057	Roanoke Valley Project Ii	Boiler, PC-Fired	Coal	517	mmBtu/hr	Dry Lime Scrubbing	0.187	93	12/7/1992
SC-0027	South Carolina Electric And Gas Company	Boiler, PC-Fired Unit No. 1	Coal	385	MW	Spray Dryer Absorber	0.25	93	7/15/1992
SC-0027		PC-Fired Boiler, Unit No. 2	Coal	385	MW	Spray Dryer Absorber	0.17	93	7/15/1992
SC-0027		PC-Fired Boiler, Unit No. 3	Coal	385	MW	Spray Dryer Absorber	0.17	93	7/15/1992
NJ-0015	Keystone Cogeneration Systems, Inc.	PC-Fired Boiler	Coal, Bituminous	2,116	mmBtu/hr	Spray Dryer Absorber	0.16	93	9/6/1991
NC-0054	Roanoke Valley Project	Boiler, PC-Fired	Coal	1,700	mmBtu/hr	Dry Lime FGD	0.213	92	1/24/1991
NJ-0014	Chambers Cogeneration Limited Partnership	2 PC-Fired Boilers	Coal	1,389	mmBtu/hr (each)	Spray Dryer Absorber	0.22	93	12/26/1990
VA-0176	Hadson Power 13	Boiler	Coal	30,228	lb/hr coal	Lime Spray Dryer	0.162	92	8/17/1990
VA-0171	Mecklenburg Cogeneration Limited Partnership	PC Fired, Boiler, 4 Units	Bituminous Coal	834.5	mmBtu/hr	Spray Dryer, Fabric Filter	0.172	92	5/9/1990

APPENDIX C
Technical Description of Particulate Matter Controls (C1)

Appendix C1 – Technical Description of Particulate Matter Controls

C1.0 FABRIC FILTER (FF)

A fabric filter or baghouse removes particulate by passing flue gas through filter bags. A pulse-jet fabric filter (PJFF) unit (like the current Big Stone PM controls) consists of isolatable compartments with common inlet and outlet manifolds containing rows of fabric filter bags. The filter bags are made from a synthetic felted material that are suspended from a tube sheet mounted at the top of each fabric filter compartment. The tube sheet separates the particulate laden flue gas from the clean flue gas. This tube sheet is a flat sheet of carbon steel with holes designed to accommodate filter bags through which the bags are hung. The flue gas passes through the PJFF by flowing from the outside of the bag to the inside, up the center of the bag through the hole in the tube sheet and out the PJFF. Fly ash particles are collected on the outside of the bags, and the cleaned gas stream passes through the fabric filter and on to the chimney. A long narrow wire cage is located within the bag to prevent collapse of the bag as the flue gas passes through it. Each filter bag alternates between relatively long periods of filtering and short periods of cleaning. During the cleaning period, fly ash that has accumulated on the bags is removed by pulses of air and then falls into a hopper for storage and subsequent disposal.

Cleaning is either initiated at a preset differential pressure across the tubesheet or based on a maximum time between cleanings. Bags in a PJFF are cleaned by directing a pulse of pressurized air down the filter bag countercurrent to the flue gas flow to induce a traveling ripple (pulse) in the filter bag. This pulse travels the length of the bag, deflecting the bag outward and separating the dust cake as it moves.

An advantage of a fabric filter over an ESP is that a fabric filter is not dependent on the resistivity of the fly ash. Since the fabric filter uses bags instead of an electric charge to remove the particles, the resistivity of the particles is not an issue. Fabric filters also have a lower dependence on particle size than ESPs. A disadvantage of fabric filters is that they have a tendency to corrode and clog with high sulfur coal applications. The high sulfur coals produce more SO₃, which tends to create problems with the fabric filters. Therefore, ESPs are typically used on high sulfur coal applications instead of fabric filters. Another disadvantage of fabric filters is the associated pressure drop. The bags, which collect a cake of particles, create an obstruction to the gas path. Fabric filters typically have approximately three times the pressure

drop of an ESP. Fabric filters have been proven to control PM removal efficiency in excess of 99%.

C1.1 ELECTROSTATIC PRECIPITATOR (ESP)

ESPs are commonly used as the primary filterable PM control device on coal fired units. The ESP discharge electrodes generate a high voltage electrical field that gives the particulate matter an electric charge (positive or negative). The charged particles will then be collected on a collection plate. A rapper or hammer system will be utilized to vibrate the collected particles off of the plates so they can fall into the hoppers for storage and subsequent disposal.

The advantages of an ESP include the fact that an ESP can be applied to high sulfur coals, and the pressure drop across an ESP is relatively low compared to other alternatives such as a fabric filter. Unlike the fabric filter, which uses bags as the filter media, an ESP does not contain elements that can plug in the presence of SO₃. The unobstructed design of the ESP results in a pressure drop that is approximately 1/3 of a corresponding fabric filter. The disadvantage of the ESP is that its effectiveness to remove particulate is dependant on the resistivity of the fly ash and particle size. ESPs have been proven to control PM removal efficiency in excess of 99%.

C1.1 COMPACT HYBRID PARTICULATE COLLECTOR (COHPAC)

A COmpact Hybrid PArticulate Collector (COHPAC) is a high air-to-cloth ratio pulse jet fabric filter located downstream of an existing ESP. The COHPAC acts as a polishing device for control of particulate emissions. The difference between a COHPAC and the fabric filter described above is that a COHPAC is installed after an ESP. The ESP prior to the COHPAC will remove the majority of the fly ash. This allows the COHPAC to have a higher air-to-cloth ratio than a typical fabric filter. The air-to-cloth ratio for a COHPAC unit is typically greater than or equal to 6 ACFM/ft² while the air-to-cloth ratio for a typical pulse jet fabric filter is approximately 3.5 to 4.0 ACFM/ft². Because Big Stone Plant does not have an ESP and already uses a fabric filter for particulate control, the use of a COHPAC is not considered further.

