

Exam Date:08/17/2015

Fullerton Farmers Elevator

Page: 1

Examiner: 2

Box 56
Fullerton , ND
County:
Phone: 701-375-7251
CCC Number:

Location/Container Numbers/Comments	Section	Capacity
PART A - ADDITIONAL SPACE TO BE INCLUDED UNDER LICENSE		
203	B	1,258,855
		Total: 1,258,855
PART B - SPACE TO BE DELETED UNDER LICENSE		
<NO BINS DELETED>		
		Total: 0
PART C - ALL SPACE TO BE INCLUDED UNDER LICENSE		
	A	359,000
	B	5,131,000
	B-G	1,500,000
	D	1,040,000
	E	545,000
		Total: 8,575,000
PART D - TOTAL CAPACITY BY FUNCTIONAL UNIT		
Fullerton 102	A B B-G D E	8,575,000
		Total: 8,575,000

Fullerton Farmers Elevator
Corp #541
Fullerton ND
Section A

Missouri Valley & Western RR

Section A

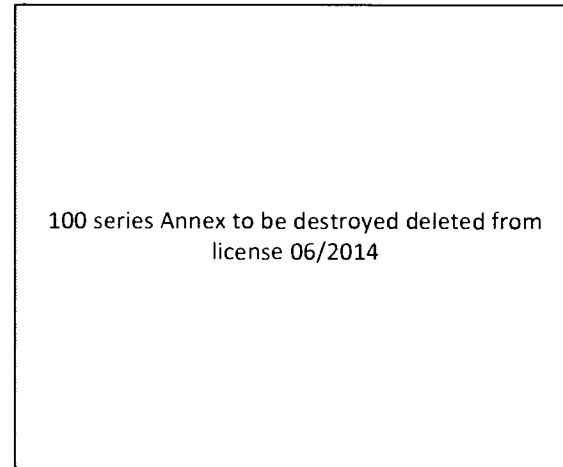
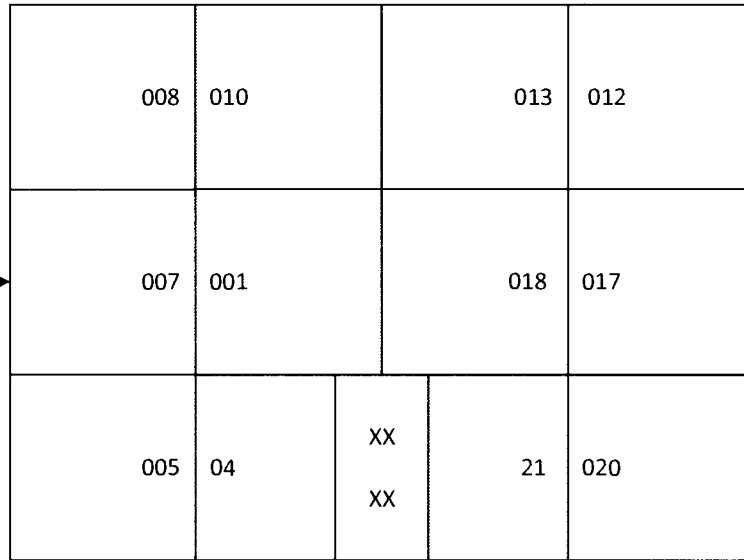

Driveway & Scale



Section A

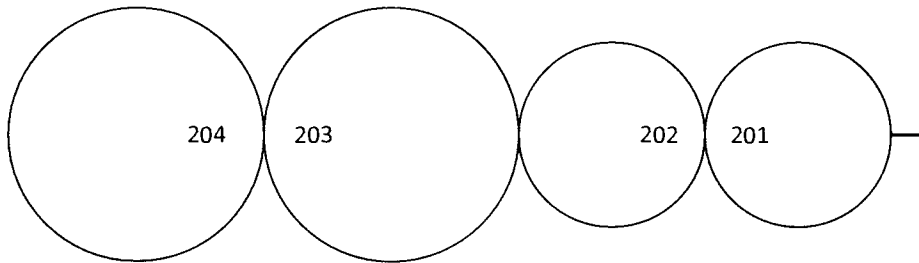

Section D 300' East
←

Section E&Y 3 blocks northeast

Section A

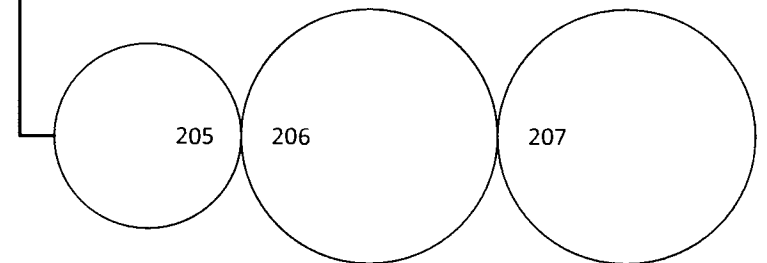

Section B & B-G ¼ mile West
→

Fullerton Farmers Elevator
Corp #541
Fullerton ND
Section D

Missouri Valley & Western RR

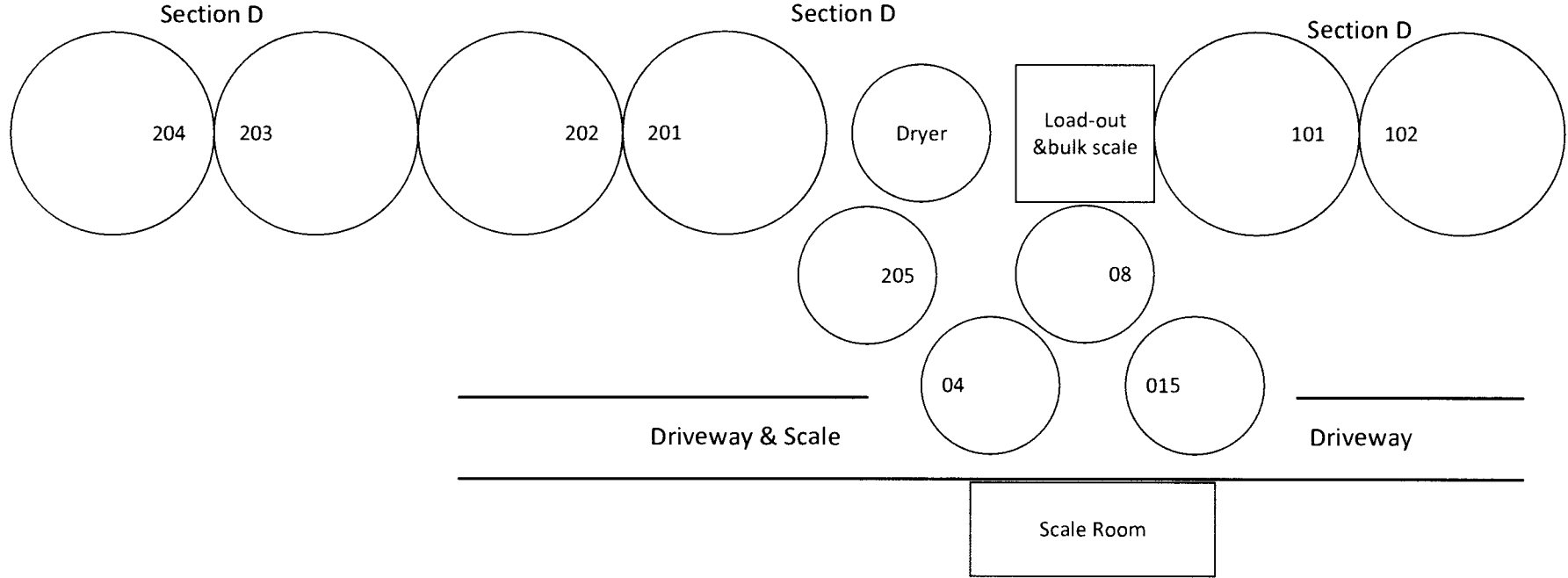

Section E & Y 3 blocks
Northeast

Section A 300' West
→

Fullerton Farmers Elevator
Corp #541
Fullerton ND
Section B

Section A ¼ mile East
←

Missouri Valley & Western RR

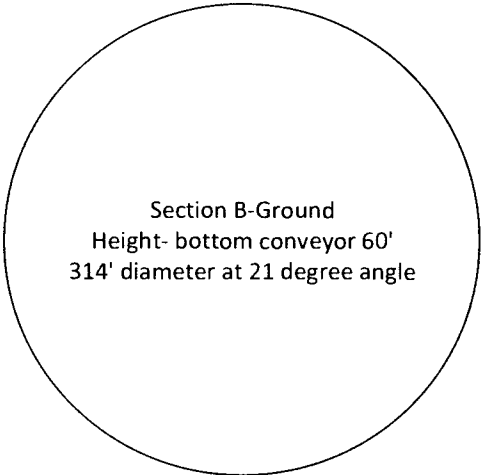
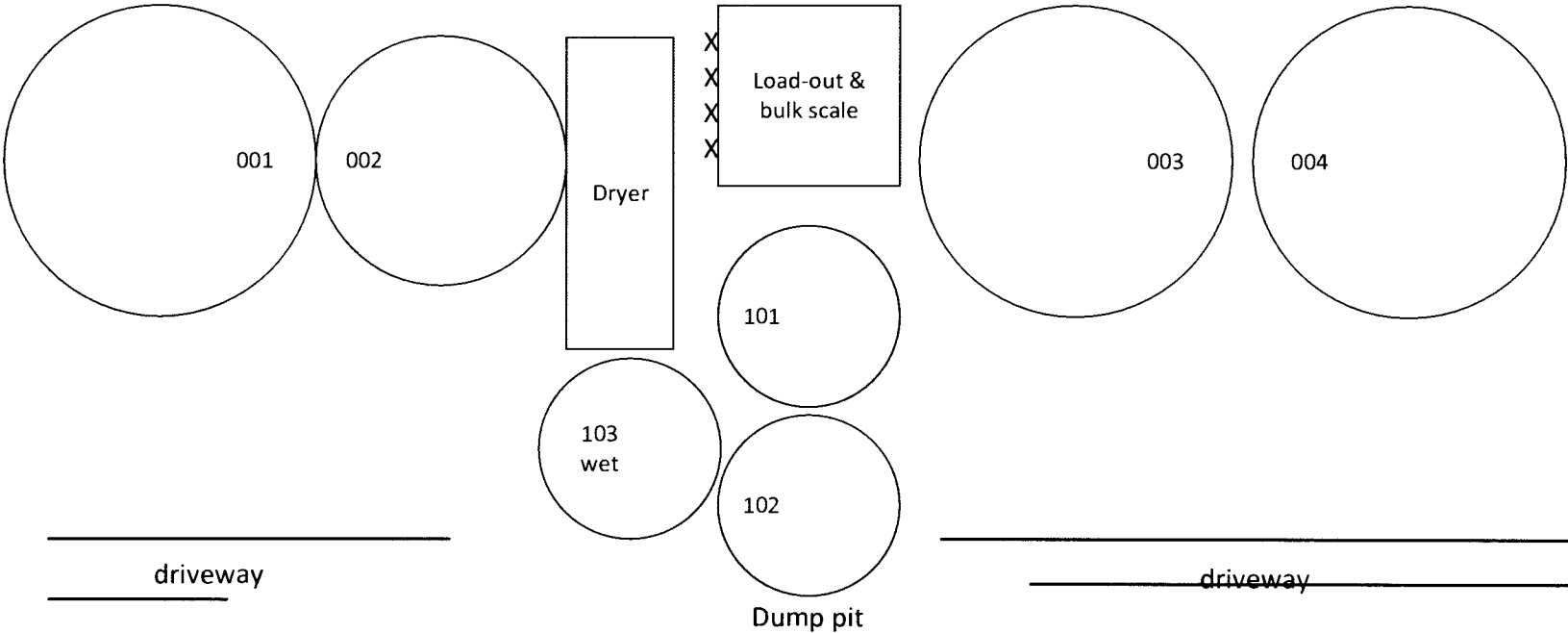

Continued on next page



Fullerton Farmers Elevator
Corp #541
Fullerton ND
Section E & Y
Located 3 blocks NE of
Sections A&D

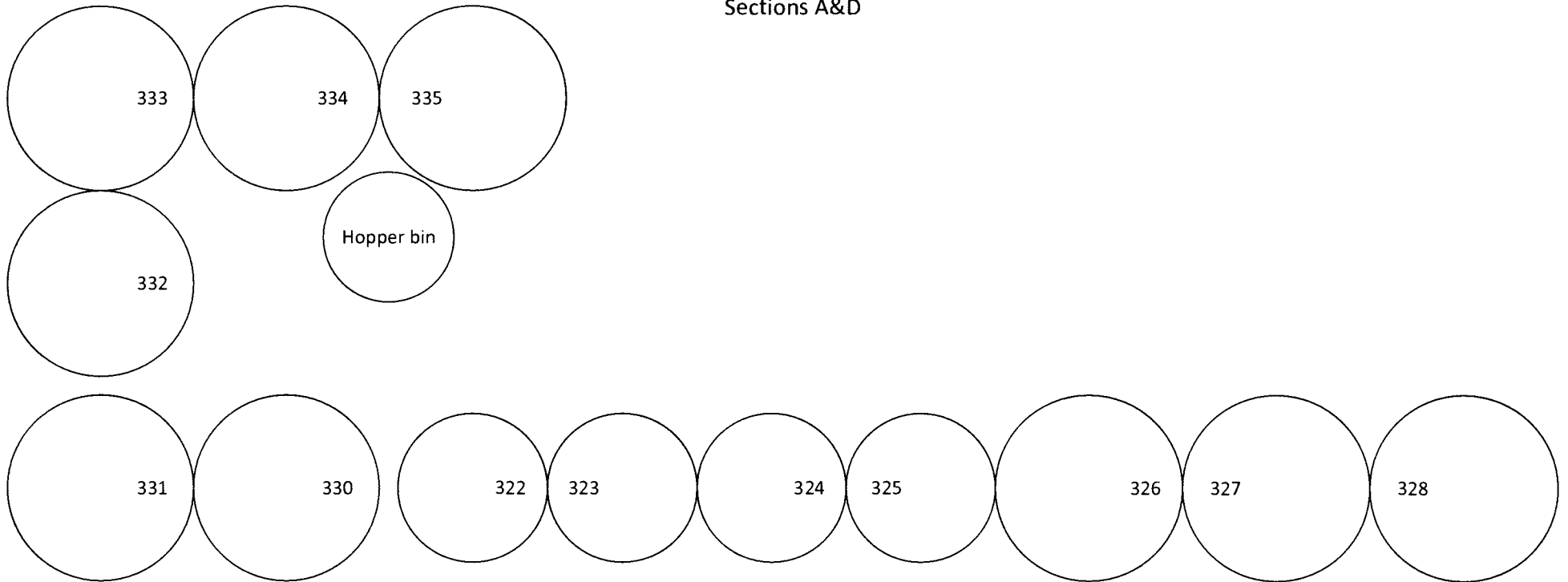

SECTION Y- vacant grass lots
for additional ground storage
as needed

Fullerton Farmers Elevator
Corp #541
Fullerton ND
Section B page 2

Original steel complex

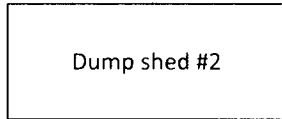

Northwest expansion of far
West steel complex Section B

XX
XX

Ground
storage
area

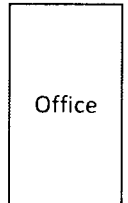
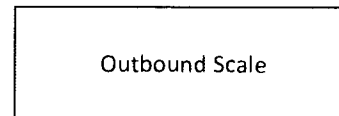
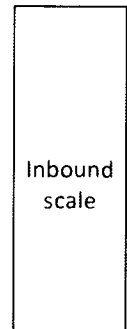
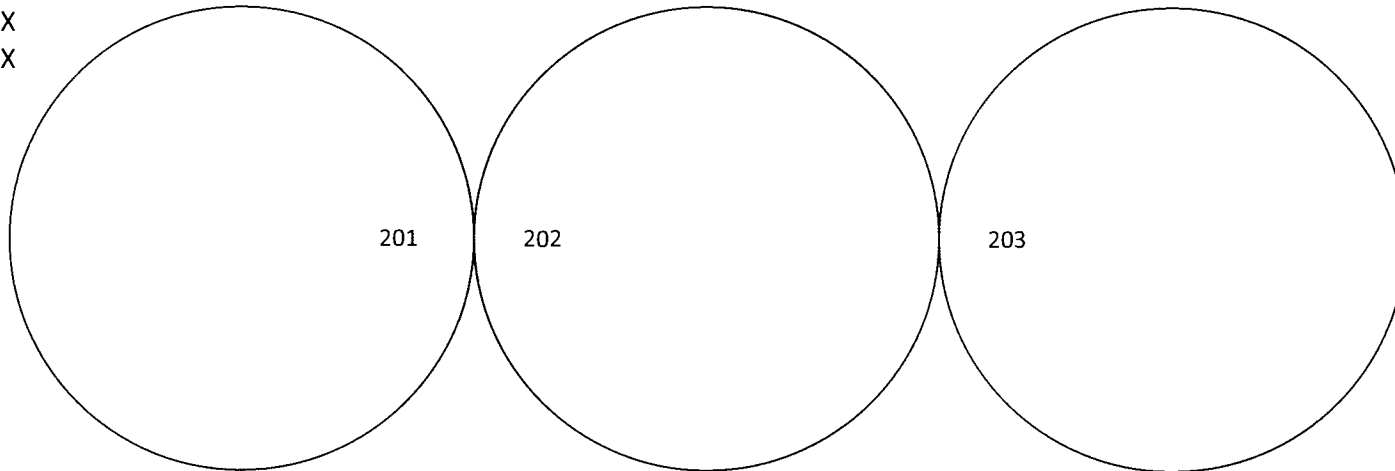

Exam Date:08/17/2015

Fullerton Farmers Elevator

Page: 1

Examiner: 2

Box 56

Fullerton , ND

County:

Status	Section	Bin Number	Bin Type	Base Point	Diameter or Bu/Ft (Irreg.) Length	Width	Side wall	Add for Hopper	Ded. for Obst.	Effective Depth	Add for Peak	Depth for Capac.	Bushels per Foot	Base Pack%	Bushel Capacity with Pack
--------	---------	------------	----------	------------	--	-------	--------------	----------------------	----------------------	--------------------	--------------------	------------------------	------------------------	---------------	------------------------------

Facility: Fullerton

Section: A

A	001	Square	floor over bins		0.000	12.30	6.900	45.00	0.00	0.00	45.000	0.000	45.0	68.2	5.20	3,229
A	004	Square	bin floor		0.000	9.200	3.500	42.00	0.00	0.00	42.000	0.000	42.0	25.9	2.50	1,115
A	005	Square	floor over bins		0.000	9.000	9.000	60.50	0.00	0.00	60.500	0.000	60.5	65.1	5.00	4,136
A	007	Square	floor over bins		0.000	12.30	9.000	46.00	0.00	0.00	46.000	0.000	46.0	89.0	5.80	4,331
A	008	Square	floor over bins		0.000	9.000	9.000	60.50	0.00	0.00	60.500	0.000	60.5	65.1	5.00	4,136
A	010	Square	floor over bins		0.000	9.200	6.900	46.00	0.00	0.00	46.000	0.000	46.0	51.0	4.50	2,452
A	012	Square	floor over bins		0.000	9.000	9.000	60.50	0.00	0.00	60.500	0.000	60.5	65.1	5.00	4,136
A	013	Square	floor over bins		0.000	9.200	6.900	46.00	0.00	0.00	46.000	0.000	46.0	51.0	4.50	2,452
A	017	Square	floor over bins		0.000	12.30	9.000	46.00	0.00	0.00	46.000	0.000	46.0	89.0	5.80	4,331
A	018	Square	floor over bins		0.000	12.30	6.900	45.00	0.00	0.00	45.000	0.000	45.0	68.2	5.20	3,229
A	020	Square	floor over bins		0.000	9.000	9.000	60.50	0.00	0.00	60.500	0.000	60.5	65.1	5.00	4,136
A	021	Square	floor over bins		0.000	9.200	4.000	42.00	0.00	0.00	42.000	0.000	42.0	29.6	2.50	1,274
A	201	Peaked	top of sidewall		30.000	0.000	0.000	58.80	0.00	0.00	58.800	1.800	60.6	568.2	9.00	37,532
A	202	Peaked	top of side wall		30.000	0.000	0.000	58.80	0.00	0.00	58.800	1.800	60.6	568.2	9.00	37,532
A	203	Peaked	top of sidewall		36.000	0.000	0.000	56.40	0.00	0.00	56.400	2.200	58.6	818.2	10.0	52,742
A	204	Peaked	top of side wall		36.000	0.000	0.000	56.40	0.00	0.00	56.400	2.200	58.6	818.2	10.0	52,742
A	205	Peaked	top of side wall		30.000	0.000	0.000	59.00	0.00	0.00	59.000	1.800	60.8	568.2	9.00	37,656
A	206	Peaked	top of side wall		33.000	0.000	0.000	59.00	0.00	0.00	59.000	2.000	61.0	687.5	9.50	45,922
A	207	Peaked	topo of sidewall		36.000	0.000	0.000	59.00	0.00	0.00	59.000	2.200	61.2	818.2	10.0	55,081

Bin count: 19

Facility: Fullerton Section: A Total: 358,164

To Even: 359,000

Client ID: 541	NDPSC Bin Capacity Chart	08/18/2015 01:41:44 PM
Exam Date:08/17/2015	Fullerton Farmers Elevator Box 56 Fullerton , ND County:	Page: 2
Examiner: 2		

Status	Section	Bin Number	Bin Type	Base Point	Diameter or Bu/Ft (Irreg.) Length	Width	Side wall	Add for Hopper	Ded. for Obst.	Effective Depth	Add for Peak	Depth for Capac.	Bushels per Foot	Base Pack%	Bushel Capacity with Pack
--------	---------	------------	----------	------------	---	-------	--------------	----------------------	----------------------	--------------------	--------------------	------------------------	------------------------	---------------	------------------------------

Facility: Fullerton

Section: B

	B	001	Peaked	topo of sidewall	91.800	0.000	0.000	59.30	0.00	0.00	59.300	6.400	65.7	5320.5	10.0	384,513
	B	002	Peaked	topo of sidewall	62.300	0.000	0.000	59.30	0.00	0.00	59.300	4.400	63.7	2450.4	10.0	171,699
	B	003	Peaked	topo of sidewall	91.800	0.000	0.000	59.30	0.00	0.00	59.300	6.400	65.7	5320.5	10.0	384,513
	B	004	Peaked	topo of sidewall	91.800	0.000	0.000	59.30	0.00	0.00	59.300	6.400	65.7	5320.5	10.0	384,513
	B	101	Peaked	topo of sidewall	15.000	0.000	0.000	19.50	3.70	0.00	23.200	0.900	24.1	142.1	5.50	3,613
	B	102	Peaked	topo of sidewall	15.000	0.000	0.000	19.50	3.70	0.00	23.200	0.900	24.1	142.1	5.50	3,613
	B	103	Peaked	topo of sidewall	24.000	0.000	0.000	49.50	3.40	0.00	52.900	1.400	54.3	363.7	7.80	21,289
	B	201	Peaked	topo of sidewall	134.50	0.000	0.000	90.80	0.00	0.00	90.800	9.400	100.2	11421.3	10.0	1,258,855
	B	202	Peaked	topo of sidewall	134.50	0.000	0.000	90.80	0.00	0.00	90.800	9.400	100.2	11421.3	10.0	1,258,855
Added	B	203	Peaked	topo of sidewall	134.50	0.000	0.000	90.80	0.00	0.00	90.800	9.400	100.2	11421.3	10.0	1,258,855

Bin count: 10

Facility: Fullerton Section: B Total: **5,130,318**

To Even: **5,131,000**

Section: B-G

	B-G	Convyr-grn	Peaked	conveyor outlet to ground	314.00	0.000	0.000	0.100	0.00	0.20	-0.100	22.00	21.9	62248.5	10.0	1,499,566
--	-----	------------	--------	---------------------------	--------	-------	-------	-------	------	------	--------	-------	------	---------	------	-----------

Bin count: 1

Facility: Fullerton Section: B-G Total: **1,499,566**

To Even: **1,500,000**

Section: D

	D	004	Peaked	top of sidewall	15.000	0.000	0.000	18.30	2.40	0.00	20.700	0.900	21.6	142.1	5.50	3,238
	D	008	Peaked	top of sidewall	15.000	0.000	0.000	18.30	2.40	0.00	20.700	0.900	21.6	142.1	5.50	3,238

Exam Date:08/17/2015

Fullerton Farmers Elevator
 Box 56
 Fullerton , ND
 County:

Status	Section	Bin Number	Bin Type	Base Point	Diameter or Bu/Ft (Irreg.) Length	Width	Side wall	Add for Hopper	Ded. for Obst.	Effective Depth	Add for Peak	Depth for Capac.	Bushels per Foot	Base Pack%	Bushel Capacity with Pack
--------	---------	------------	----------	------------	---	-------	--------------	----------------------	----------------------	--------------------	--------------------	------------------------	------------------------	---------------	------------------------------

Facility: Fullerton

Section: D

D	015	Peaked	top of sidewall		15.000	0.000	0.000	18.30	2.40	0.00	20.700	0.900	21.6	142.1	5.50	3,238
D	101	Peaked	top of sidewall		48.000	0.000	0.000	66.00	0.00	0.00	66.000	3.400	69.4	1454.6	10.0	111,044
D	102	Peaked	top of sidewall		48.000	0.000	0.000	66.00	0.00	0.00	66.000	3.400	69.4	1454.6	10.0	111,044
D	201	Peaked	top of sidewall		48.000	0.000	0.000	66.00	0.00	0.00	66.000	3.400	69.4	1454.6	10.0	111,044
D	202	Peaked	top of sidewall		48.000	0.000	0.000	66.00	0.00	0.00	66.000	3.400	69.4	1454.6	10.0	111,044
D	203	Peaked	top of sidewall		60.000	0.000	0.000	73.00	0.00	0.00	73.000	4.200	77.2	2272.9	10.0	193,015
D	204	Peaked	top of sidewall		78.000	0.000	0.000	84.00	0.00	0.00	84.000	5.500	89.5	3841.1	10.0	378,156
D	205	Peaked	top of sidewall		21.000	0.000	0.000	44.00	3.20	0.00	47.200	1.300	48.5	278.4	6.80	14,420

Bin count: 10

Facility: Fullerton Section: D Total: 1,039,481

To Even: 1,040,000

Section: E

E	322	Peaked	top of sidewall		21.000	0.000	0.000	27.00	0.00	0.00	27.000	1.300	28.3	278.4	6.80	8,415
E	323	Peaked	top of sidewall		21.000	0.000	0.000	27.00	0.00	0.00	27.000	1.300	28.3	278.4	6.80	8,415
E	324	Peaked	top of sidewall		21.000	0.000	0.000	27.00	0.00	0.00	27.000	1.300	28.3	278.4	6.80	8,415
E	325	Peaked	top of sidewall		21.000	0.000	0.000	27.00	0.00	0.00	27.000	1.300	28.3	278.4	6.80	8,415
E	326	Peaked	top of sidewall		48.000	0.000	0.000	32.00	0.00	0.00	32.000	3.400	35.4	1454.6	10.0	56,642
E	327	Peaked	top of sidewall		48.000	0.000	0.000	32.00	0.00	0.00	32.000	3.400	35.4	1454.6	10.0	56,642
E	328	Peaked	top of sidewall		48.000	0.000	0.000	32.00	0.00	0.00	32.000	3.400	35.4	1454.6	10.0	56,642
E	330	Peaked	top of sidewall		48.000	0.000	0.000	32.10	0.00	0.00	32.100	3.400	35.5	1454.6	10.0	56,802
E	331	Peaked	top of sidewall		48.000	0.000	0.000	32.10	0.00	0.00	32.100	3.400	35.5	1454.6	10.0	56,802
E	332	Peaked	top of sidewall		48.000	0.000	0.000	32.10	0.00	0.00	32.100	3.400	35.5	1454.6	10.0	56,802

Client ID: 541	NDPSC Bin Capacity Chart	08/18/2015 01:41:44 PM
Exam Date:08/17/2015	Fullerton Farmers Elevator	Page: 4
Examiner: 2	Box 56 Fullerton , ND County:	

Status	Section	Bin Number	Bin Type	Base Point	Diameter or Bu/Ft (Irreg.) Length	Width	Side wall	Add for Hopper	Ded. for Obst.	Effective Depth	Add for Peak	Depth for Capac.	Bushels per Foot	Base Pack%	Bushel Capacity with Pack
--------	---------	------------	----------	------------	---	-------	--------------	----------------------	----------------------	--------------------	--------------------	------------------------	------------------------	---------------	------------------------------

Facility: Fullerton

Section: E

E	333	Peaked	top of sidewall		48.000	0.000	0.000	32.10	0.00	0.00	32.100	3.400	35.5	1454.6	10.0	56,802
E	334	Peaked	top of sidewall		48.000	0.000	0.000	32.10	0.00	0.00	32.100	3.400	35.5	1454.6	10.0	56,802
E	335	Peaked	top of sidewall		48.000	0.000	0.000	32.00	0.00	0.00	32.000	3.400	35.4	1454.6	10.0	56,642

Bin count: 13

Facility: Fullerton Section: E Total: 544,238

To Even: 545,000

Overall Licensed Bin Capacity for:	Licensed Capacity: (includes pack)	<u>8,571,767 Bu.</u>
Fullerton Farmers Elevator		
Bin count: 53	Licensed Capacity (to even): (includes pack and section totals are rounded up to next highest 1000)	<u>8,575,000 Bu.</u>