

Exam Date:09/23/2015

Fessenden Cooperative Association

Page: 1

Examiner: 2

PO Box 126
Fessenden , ND
County:

Status	Section	Bin Number	Bin Type	Base Point	Diameter or Bu/Ft (Irreg).		Side wall	Add for Hopper	Ded. for Obst.	Effective Depth	Add for Peak	Depth for Capac.	Bushels per Foot	Base Pack%	Bushel Capacity with Pack	
					Length	Width										
	1A	001	Peaked	top of sidewall	16.000	0.000	0.000	17.00	2.70	0.00	19.700	1.000	20.7	161.6	5.80	3,539
	1A	002	Peaked	top of sidewall	16.000	0.000	0.000	17.00	2.70	0.00	19.700	1.000	20.7	161.6	5.80	3,539
	1A	003	Peaked	top of sidewall	16.000	0.000	0.000	17.00	2.70	0.00	19.700	1.000	20.7	161.6	5.80	3,539
	1A	004	Peaked	top of sidewall	49.500	0.000	0.000	34.50	0.00	0.00	34.500	3.500	38.0	1547.0	10.0	64,665
	1A	005	Peaked	top of sidewall	49.500	0.000	0.000	34.50	0.00	0.00	34.500	3.500	38.0	1547.0	10.0	64,665
	1A	006	Flat	bulk storage	0.000	200.0	60.00	20.80	0.00	0.00	20.800	0.000	20.8	9646.3	10.0	220,707
	1A	007	Flat	bag storage	0.000	60.00	30.00	3.200	0.00	0.00	3.200	0.000	3.2	1446.9	10.0	5,093
	1A	008	Peaked	top of sidewall	53.800	0.000	0.000	35.50	0.00	0.00	35.500	3.800	39.3	1827.4	10.0	78,999
	1A	009	Peaked	top of sidewall	53.800	0.000	0.000	35.50	0.00	0.00	35.500	3.800	39.3	1827.4	10.0	78,999
	1A	101A	Square	top of sidewall	0.000	12.00	9.000	12.00	1.70	0.00	13.700	0.000	13.7	86.8	5.80	1,258
	1A	102 A	Square	top of sidewall	0.000	12.00	9.000	12.00	1.70	0.00	13.700	0.000	13.7	86.8	5.80	1,258
	1A	103 A	Square	top of sidewall	0.000	12.00	9.000	12.00	1.70	0.00	13.700	0.000	13.7	86.8	5.80	1,258
	1A	201	Peaked		16.000	0.000	0.000	15.00	2.00	0.00	17.000	1.000	18.0	161.6	5.80	3,078
	1A	202	Peaked		16.000	0.000	0.000	20.00	2.00	0.00	22.000	1.000	23.0	161.6	5.80	3,933
	1A	203	Peaked		16.000	0.000	0.000	15.00	2.00	0.00	17.000	1.000	18.0	161.6	5.80	3,078
	1A	204	Peaked		16.000	0.000	0.000	15.00	2.00	0.00	17.000	1.000	18.0	161.6	5.80	3,078
	1A	205	Peaked		16.000	0.000	0.000	15.00	2.00	0.00	17.000	1.000	18.0	161.6	5.80	3,078
	1A	206	Peaked		16.000	0.000	0.000	15.00	2.00	0.00	17.000	1.000	18.0	161.6	5.80	3,078
	1A	207	Peaked		16.000	0.000	0.000	20.00	2.00	0.00	22.000	1.000	23.0	161.6	5.80	3,933
	1A	208	Peaked		16.000	0.000	0.000	15.00	2.00	0.00	17.000	1.000	18.0	161.6	5.80	3,078
	1A	209	Peaked		16.000	0.000	0.000	20.00	2.00	0.00	22.000	1.000	23.0	161.6	5.80	3,933
	1A	210	Peaked		16.000	0.000	0.000	20.00	2.00	0.00	22.000	1.000	23.0	161.6	5.80	3,933

Section: 1A

Exam Date:09/23/2015

Fessenden Cooperative Association

Page: 2

Examiner: 2

PO Box 126
Fessenden, ND
County:

Status	Section	Bin Number	Bin Type	Base Point	Diameter or Bu/Ft (Irreg).		Side	Add for Hopper	Ded. for Obst.	Effective Depth	Add for Peak	Depth for Capac.	Bushels per Foot	Base Pack%	Bushel Capacity with Pack	
					Length	Width	wall			Depth						
Bin count:		22													Facility: Fessenden Section: 1A Total:	561,719
														To Even:	562,000	

Section: 1B

1B	001	Flat	west bulk warehouse	0.000	120.0	60.00	7.000	0.00	0.00	7.000	0.000	7.0	5787.8	10.0	44,567	
1B	002	Quonset	west bulk quonset	0.000	124.0	68.00	12.00	0.00	0.00	12.000	0.000	12.0	6634.6	10.0	87,578	
Bin count:		2													Facility: Fessenden Section: 1B Total:	132,145
														To Even:	133,000	

Section: A

A	001	Round	work floor	26.000	0.000	0.000	121.5	0.00	0.00	121.50	0.000	121.5	426.8	8.20	56,108
A	002	Round	work floor	26.000	0.000	0.000	121.5	0.00	0.00	121.50	0.000	121.5	426.8	8.20	56,108
A	003	Round	work floor	26.000	0.000	0.000	121.5	0.00	0.00	121.50	0.000	121.5	426.8	8.20	56,108
A	004	Round	work floor	26.000	0.000	0.000	121.5	0.00	0.00	121.50	0.000	121.5	426.8	8.20	56,108
A	005	Irregular	work floor	62.100	0.000	0.000	57.00	0.00	0.00	57.000	0.000	57.0	62.1	5.00	3,717
A	006 T	Irregular	work floor	59.400	0.000	0.000	15.50	0.00	0.00	15.500	0.000	15.5	59.4	4.80	965
A	006 B	Irregular	work floor - top 15.5'	59.400	0.000	0.000	35.00	0.00	0.00	35.000	0.000	35.0	59.4	4.80	2,179
A	006A T	Irregular	work floor	62.400	0.000	0.000	15.50	0.00	0.00	15.500	0.000	15.5	62.4	5.00	1,015
A	006A B	Irregular	work floor - top 15.5'	62.400	0.000	0.000	35.00	0.00	0.00	35.000	0.000	35.0	62.4	5.00	2,293
A	007	Irregular	work floor	28.800	0.000	0.000	96.50	0.00	0.00	96.500	0.000	96.5	28.8	2.50	2,848
A	008	Irregular	work floor	28.900	0.000	0.000	96.50	0.00	0.00	96.500	0.000	96.5	28.9	2.50	2,859
A	009	Irregular	work floor	77.000	0.000	0.000	96.50	0.00	0.00	96.500	0.000	96.5	77.0	5.50	7,840
A	010	Irregular	work floor	76.000	0.000	0.000	96.50	0.00	0.00	96.500	0.000	96.5	76.0	5.50	7,737
A	011	Irregular	work floor	76.900	0.000	0.000	97.00	0.00	0.00	97.000	0.000	97.0	76.9	5.50	7,869

Exam Date:09/23/2015

Fessenden Cooperative Association

Page: 3

Examiner: 2

PO Box 126
Fessenden, ND
County:

Status	Section	Bin Number	Bin Type	Base Point	Diameter or Bu/Ft (Irreg.)		Side wall	Add for Hopper	Ded. for Obst.	Effective Depth	Add for Peak	Depth for Capac.	Bushels per Foot	Base Pack%	Bushel Capacity with Pack	
					Length	Width										
	A	012	Irregular	work floor	76.400	0.000	0.000	97.00	0.00	0.00	97.000	0.000	97.0	76.4	5.50	7,819
	A	013	Irregular	work floor	37.900	0.000	0.000	96.50	0.00	0.00	96.500	0.000	96.5	37.9	3.00	3,767
	A	014	Irregular	work floor	37.900	0.000	0.000	96.50	0.00	0.00	96.500	0.000	96.5	37.9	3.00	3,767
	A	015	Irregular	work floor	37.900	0.000	0.000	96.50	0.00	0.00	96.500	0.000	96.5	37.9	3.00	3,767
	A	016	Irregular	work floor	37.900	0.000	0.000	96.50	0.00	0.00	96.500	0.000	96.5	37.9	3.00	3,767
	A	017	Irregular	work floor	37.900	0.000	0.000	96.50	0.00	0.00	96.500	0.000	96.5	37.9	3.00	3,767
	A	018	Irregular	work floor	37.900	0.000	0.000	96.50	0.00	0.00	96.500	0.000	96.5	37.9	3.00	3,767
	A	019	Irregular	work floor	37.900	0.000	0.000	96.30	0.00	0.00	96.300	0.000	96.3	37.9	3.00	3,760
	A	020	Irregular	work floor	37.900	0.000	0.000	96.30	0.00	0.00	96.300	0.000	96.3	37.9	3.00	3,760
	A	021	Irregular	work floor	37.900	0.000	0.000	96.30	0.00	0.00	96.300	0.000	96.3	37.9	3.00	3,760
	A	022	Irregular	work floor	75.400	0.000	0.000	97.00	0.00	0.00	97.000	0.000	97.0	75.4	5.50	7,716
	A	023	Irregular	work floor	74.800	0.000	0.000	97.00	0.00	0.00	97.000	0.000	97.0	74.8	5.50	7,655
	A	024	Irregular	work floor	76.500	0.000	0.000	96.50	0.00	0.00	96.500	0.000	96.5	76.5	5.50	7,788
	A	025	Irregular	work floor	76.300	0.000	0.000	96.50	0.00	0.00	96.500	0.000	96.5	76.3	5.50	7,768
	A	026	Irregular	work floor	54.800	0.000	0.000	96.50	0.00	0.00	96.500	0.000	96.5	54.8	4.50	5,526
	A	027	Irregular	work floor	53.100	0.000	0.000	96.50	0.00	0.00	96.500	0.000	96.5	53.1	4.50	5,355
	A	028	Irregular	work floor	50.000	0.000	0.000	100.5	0.00	0.00	100.500	0.000	100.5	50.0	4.20	5,236
	A	029	Irregular	work floor	27.100	0.000	0.000	100.5	0.00	0.00	100.500	0.000	100.5	27.1	2.50	2,792
	A	030	Irregular	work floor	25.500	0.000	0.000	100.5	0.00	0.00	100.500	0.000	100.5	25.5	2.50	2,627
	A	031	Irregular	work floor	58.400	0.000	0.000	88.00	0.00	0.00	88.000	0.000	88.0	58.4	4.80	5,386
	A	032	Irregular	work floor	56.800	0.000	0.000	88.00	0.00	0.00	88.000	0.000	88.0	56.8	4.80	5,238
	A	033	Irregular	work floor	58.400	0.000	0.000	88.00	0.00	0.00	88.000	0.000	88.0	58.4	4.80	5,386
	A	034	Irregular	work floor	57.900	0.000	0.000	88.00	0.00	0.00	88.000	0.000	88.0	57.9	4.80	5,340

Section: A

Exam Date:09/23/2015

Fessenden Cooperative Association

Page: 4

Examiner: 2

PO Box 126
Fessenden, ND
County:

Status	Section	Bin Number	Bin Type	Base Point	Diameter or Bu/Ft (Irreg).		Side wall	Add for Hopper	Ded. for Obst.	Effective Depth	Add for Peak	Depth for Capac.	Bushels per Foot	Base Pack%	Bushel Capacity with Pack	
					Length	Width										
A	035		Irregular	work floor	57.900	0.000	0.000	88.00	0.00	0.00	88.000	0.000	88.0	57.9	4.80	5,340
A	036		Irregular	work floor	57.900	0.000	0.000	88.00	0.00	0.00	88.000	0.000	88.0	57.9	4.80	5,340
A	037		Peaked	top of sidewall	42.000	0.000	0.000	64.00	0.00	0.00	64.000	2.500	66.5	1113.7	10.0	81,467
A	038		Peaked	top of sidewall	35.900	0.000	0.000	58.60	0.00	0.00	58.600	2.200	60.8	813.7	10.0	54,420
A	039		Peaked	top of sidewall	29.900	0.000	0.000	58.60	0.00	0.00	58.600	1.800	60.4	564.4	9.00	37,158
A	101A		Round	TOP OF SLAB	34.000	8.487	8.487	137.5	0.00	0.00	137.50	0.000	137.5	729.8	9.80	110,182
A	102A		Round	TOP OF SLAB	34.000	8.487	8.487	137.5	0.00	0.00	137.50	0.000	137.5	729.8	9.80	110,182
A	103A		Round	TOP OF SLAB	34.000	8.487	8.487	137.5	0.00	0.00	137.50	0.000	137.5	729.8	9.80	110,182
A	104A		Round	TOP OF SLAB	34.000	8.487	8.487	137.5	0.00	0.00	137.50	0.000	137.5	729.8	9.80	110,182
A	105A		Round	TOP OF SLAB	34.000	8.487	8.487	137.5	0.00	0.00	137.50	0.000	137.5	729.8	9.80	110,182
A	106A		Round	TOP OF SLAB	34.000	8.487	8.487	137.5	0.00	0.00	137.50	0.000	137.5	729.8	9.80	110,182
A	107A		Round	TOP OF SLAB	34.000	8.487	8.487	137.5	0.00	0.00	137.50	0.000	137.5	729.8	9.80	110,182
A	108A		Round	TOP OF SLAB	34.000	8.487	8.487	137.5	0.00	0.00	137.50	0.000	137.5	729.8	9.80	110,182
A	109A		Interstice	TOP OF SLAB	32.400	8.487	8.487	137.5	0.00	0.00	137.50	0.000	137.5	181.1	5.80	26,345
A	110A		Interstice	TOP OF SLAB	32.400	8.487	8.487	137.5	0.00	0.00	137.50	0.000	137.5	181.1	5.80	26,345
A	111A		Interstice	TOP OF SLAB	32.400	8.487	8.487	137.5	0.00	0.00	137.50	0.000	137.5	181.1	5.80	26,345
A	202		Square	work floor	0.000	6.600	5.200	44.00	0.00	0.00	44.000	0.000	44.0	27.6	2.50	1,244
A	203		Square	work floor	0.000	4.600	4.300	45.00	0.00	0.00	45.000	0.000	45.0	15.9	2.00	730
A	204		Square	work floor	0.000	4.600	4.300	47.00	0.00	0.00	47.000	0.000	47.0	15.9	2.00	762
A	205 A		Square	work floor part of 205	0.000	5.600	4.000	23.00	0.00	0.00	23.000	0.000	23.0	18.0	2.00	422
A	205 T		Square	work floor	0.000	4.000	2.300	23.00	0.00	0.00	23.000	0.000	23.0	7.4	2.00	173
A	205 B		Square	work floor - top 23'	0.000	8.000	4.000	17.00	0.00	0.00	17.000	0.000	17.0	25.7	2.50	448
A	206		Square	work floor -	0.000	7.000	5.200	45.00	0.00	0.00	45.000	0.000	45.0	29.3	2.50	1,352

Section: A

Exam Date:09/23/2015

Fessenden Cooperative Association

Page: 5

Examiner: 2

PO Box 126
Fessenden, ND
County:

Status	Section	Bin Number	Bin Type	Base Point	Diameter or Bu/Ft (Irreg.)		Side wall	Add for Hopper	Ded. for Obst.	Effective Depth	Add for Peak	Depth for Capac.	Bushels per Foot	Base Pack%	Bushel Capacity with Pack	
					Length	Width										
	A	207 T	Square	work floor	0.000	9.400	4.100	45.00	0.00	0.00	45.000	0.000	45.0	31.0	2.50	1,430
	A	207 B	Square	work floor - top 45'	0.000	9.300	8.100	16.00	0.00	0.00	16.000	0.000	16.0	60.6	4.80	1,017
	A	208	Square	work floor	0.000	12.00	9.300	46.00	0.00	0.00	46.000	0.000	46.0	89.7	5.80	4,365
	A	209	Square	work floor	0.000	7.000	6.000	45.00	0.00	0.00	45.000	0.000	45.0	33.8	2.50	1,559
	A	210	Square	work floor	0.000	9.300	8.100	61.00	0.00	0.00	61.000	0.000	61.0	60.6	4.80	3,874
	A	211 T	Square	work floor	0.000	4.500	4.200	12.00	0.00	0.00	12.000	0.000	12.0	15.2	2.00	186
	A	211 B	Square	work floor - top 12'	0.000	8.400	7.000	25.00	0.00	0.00	25.000	0.000	25.0	47.3	4.00	1,230
	A	212 T	Square	work floor	0.000	4.600	3.400	12.00	0.00	0.00	12.000	0.000	12.0	12.6	2.00	154
	A	212 B	Square	work floor - top 12'	0.000	8.400	6.600	25.00	0.00	0.00	25.000	0.000	25.0	44.6	3.50	1,154
	A	213	Square	work floor	0.000	9.100	8.400	61.00	0.00	0.00	61.000	0.000	61.0	61.4	4.80	3,925
	A	214	Square	work floor	0.000	6.600	6.000	44.00	0.00	0.00	44.000	0.000	44.0	31.8	2.50	1,434
	A	215	Square	work floor	0.000	11.20	9.100	46.00	0.00	0.00	46.000	0.000	46.0	81.9	5.50	3,974
	A	216 T	Square	work floor	0.000	9.100	4.100	45.00	0.00	0.00	45.000	0.000	45.0	30.0	2.50	1,384
	A	216 B	Square	work floor - top 45'	0.000	9.100	8.600	16.00	0.00	0.00	16.000	0.000	16.0	62.9	5.00	1,056
	A	217	Square	work floor	0.000	4.300	4.300	41.00	0.00	0.00	41.000	0.000	41.0	14.9	2.00	623
	A	218	Square	work floor	0.000	4.300	4.300	41.00	0.00	0.00	41.000	0.000	41.0	14.9	2.00	623
	A	220 T	Square	work floor	0.000	14.30	9.600	54.00	0.00	0.00	54.000	0.000	54.0	110.4	6.20	6,332
	A	220 B	Square	work floor - top 54'	0.000	12.00	9.600	7.000	0.00	0.00	7.000	0.000	7.0	92.6	5.80	686
	A	221 T	Square	work floor	0.000	14.30	9.600	54.00	0.00	0.00	54.000	0.000	54.0	110.4	6.20	6,332
	A	221 B	Square	work floor - top 54'	0.000	12.00	9.600	7.000	0.00	0.00	7.000	0.000	7.0	92.6	5.80	686
	A	222 T	Square	work floor	0.000	14.30	9.600	54.00	0.00	0.00	54.000	0.000	54.0	110.4	6.20	6,332
	A	222 B	Square	work floor - top 54'	0.000	12.00	9.600	7.000	0.00	0.00	7.000	0.000	7.0	92.6	5.80	686
	A	223 T	Square	work floor	0.000	14.30	9.400	31.00	0.00	0.00	31.000	0.000	31.0	108.1	6.20	3,559

Section: A

NDPSC Bin Capacity Chart

Exam Date:09/23/2015

Fessenden Cooperative Association
PO Box 126
Fessenden , ND
County:

Examiner: 2

Status	Section	Bin Number	Bin Type	Base Point	Diameter or Bu/Ft (Irreg).		Side wall	Add for Hopper	Ded. for Obst.	Effective Depth	Add for Peak	Depth for Capac.	Bushels per Foot	Base Pack%	Bushel Capacity with Pack	
					Length	Width										
A	223 M		Square	work floor - top 31' blind bin	0.000	14.30	9.400	23.00	0.00	0.00	23.000	0.000	23.0	108.1	6.20	2,640
A	223B		Square	work floor - top & middle 54'	0.000	12.00	9.400	7.000	0.00	0.00	7.000	0.000	7.0	90.7	5.80	672
A	224 T		Square	work floor	0.000	14.30	9.600	54.00	0.00	0.00	54.000	0.000	54.0	110.4	6.20	6,332
A	224 B		Square	work floor - top 54'	0.000	12.00	9.600	7.000	0.00	0.00	7.000	0.000	7.0	92.6	5.80	686
A	225 T		Square	work floor	0.000	14.30	9.400	54.00	0.00	0.00	54.000	0.000	54.0	108.1	6.20	6,199
A	225 B		Square	work floor - top 54'	0.000	12.00	9.400	7.000	0.00	0.00	7.000	0.000	7.0	90.7	5.80	672
A	301 T		Square	work floor	0.000	11.50	11.50	39.00	0.00	0.00	39.000	0.000	39.0	106.3	6.20	4,403
A	301 B		Square	work floor - top 39'	0.000	11.50	9.000	3.000	0.00	0.00	3.000	0.000	3.0	83.2	5.80	265
A	302 T		Square	work floor	0.000	11.50	11.50	39.00	0.00	0.00	39.000	0.000	39.0	106.3	6.20	4,403
A	302 B		Square	work floor - top 39'	0.000	11.50	8.700	3.000	0.00	0.00	3.000	0.000	3.0	80.4	5.50	254
A	303 T		Square	work floor	0.000	11.50	11.50	39.00	0.00	0.00	39.000	0.000	39.0	106.3	6.20	4,403
A	303 B		Square	work floor - top 39'	0.000	11.50	9.000	3.000	0.00	0.00	3.000	0.000	3.0	83.2	5.80	265
A	304 T		Square	work floor	0.000	11.50	11.50	39.00	0.00	0.00	39.000	0.000	39.0	106.3	6.20	4,403
A	304 B		Square	work floor - top 39'	0.000	11.50	8.700	3.000	0.00	0.00	3.000	0.000	3.0	80.4	5.50	254
A	305 T		Square	work floor	0.000	11.50	11.40	39.00	0.00	0.00	39.000	0.000	39.0	105.4	6.20	4,366
A	305 B		Square	work floor - top 39'	0.000	11.40	8.700	3.000	0.00	0.00	3.000	0.000	3.0	79.7	5.50	252
A	306 T		Square	work floor	0.000	11.50	11.40	39.00	0.00	0.00	39.000	0.000	39.0	105.4	6.20	4,366
A	306 B		Square	work floor - top 39'	0.000	11.40	8.700	3.000	0.00	0.00	3.000	0.000	3.0	79.7	5.50	252

Bin count: 101

Facility: Fessenden Section: A Total: **1,626,303**

To Even: **1,627,000**

Exam Date:09/23/2015

Fessenden Cooperative Association

Page: 7

Examiner: 2

PO Box 126
Fessenden , ND
County:

Status	Section	Bin Number	Bin Type	Base Point	Diameter or Bu/Ft (Irreg).		Side wall	Add for Hopper	Ded. for Obst.	Effective Depth	Add for Peak	Depth for Capac.	Bushels per Foot	Base Pack%	Bushel Capacity with Pack	
					Length	Width										
	A-H	003	Square	floor over bins	0.000	5.000	3.500	39.00	0.00	0.00	39.000	0.000	39.0	14.1	2.00	561
	A-H	004	Square	floor over bins	0.000	5.500	5.000	41.00	0.00	0.00	41.000	0.000	41.0	22.1	2.00	924
	A-H	005	Square	floor over bins	0.000	5.500	5.000	41.00	0.00	0.00	41.000	0.000	41.0	22.1	2.00	924
	A-H	006 T	Square	floor over bins	0.000	11.00	5.000	41.00	0.00	0.00	41.000	0.000	41.0	44.2	3.50	1,875
	A-H	006 B	Square	41' to bottom	0.000	10.50	11.00	14.00	0.00	0.00	14.000	0.000	14.0	92.8	5.80	1,374
	A-H	007	Square	floor over bins	0.000	10.50	5.000	38.00	0.00	0.00	38.000	0.000	38.0	42.2	3.50	1,660
	A-H	009	Square	floor over bins	0.000	10.50	5.500	38.00	0.00	0.00	38.000	0.000	38.0	46.4	4.00	1,834
	A-H	010	Square	floor over bins	0.000	10.50	6.500	38.00	0.00	0.00	38.000	0.000	38.0	54.9	4.50	2,180
	A-H	011 T	Square	floor over bins	0.000	10.50	5.000	38.00	0.00	0.00	38.000	0.000	38.0	42.2	3.50	1,660
	A-H	011 B	Square	38' to bottom	0.000	10.50	11.00	17.00	0.00	0.00	17.000	0.000	17.0	92.8	5.80	1,670
	A-H	012	Square	floor over bins	0.000	10.50	5.500	37.00	0.00	0.00	37.000	0.000	37.0	46.4	4.00	1,786
	A-H	013	Square	floor over bins	0.000	10.50	6.500	36.00	0.00	0.00	36.000	0.000	36.0	54.9	4.50	2,065
	A-H	015	Square	floor over bins	0.000	10.50	6.500	36.00	0.00	0.00	36.000	0.000	36.0	54.9	4.50	2,065
	A-H	016	Square	floor over bins	0.000	10.50	5.500	37.00	0.00	0.00	37.000	0.000	37.0	46.4	4.00	1,786
	A-H	017 T	Square	floor over bins	0.000	10.50	5.000	38.00	0.00	0.00	38.000	0.000	38.0	42.2	3.50	1,660
	A-H	017 B	Square	38' to bottom	0.000	11.00	10.50	17.00	0.00	0.00	17.000	0.000	17.0	92.8	5.80	1,670
	A-H	018	Square	floor over bins	0.000	10.50	6.500	38.00	0.00	0.00	38.000	0.000	38.0	54.9	4.50	2,180
	A-H	019	Square	floor over bins	0.000	5.500	5.000	38.00	0.00	0.00	38.000	0.000	38.0	22.1	2.00	857
	A-H	021 T	Square	floor over bins	0.000	10.50	5.000	38.00	0.00	0.00	38.000	0.000	38.0	42.2	3.50	1,660
	A-H	021 B	Square	38' to bottom	0.000	10.50	11.00	17.00	0.00	0.00	17.000	0.000	17.0	92.8	5.80	1,670
	A-H	022	Square	floor over bins	0.000	5.500	5.000	38.00	0.00	0.00	38.000	0.000	38.0	22.1	2.00	857
	A-H	023 T	Square	floor over bins	0.000	10.50	5.000	38.00	0.00	0.00	38.000	0.000	38.0	42.2	3.50	1,660
	A-H	023 B	Square	38' to bottom	0.000	10.50	11.00	17.00	0.00	0.00	17.000	0.000	17.0	92.8	5.80	1,670

Section: A-H

Exam Date:09/23/2015

Fessenden Cooperative Association

Page: 8

Examiner: 2

PO Box 126

Fessenden , ND

County:

Status	Section	Bin Number	Bin Type	Base Point	Diameter or Bu/Ft (Irreg).		Side wall	Add for Hopper	Ded. for Obst.	Effective Depth	Add for Peak	Depth for Capac.	Bushels per Foot	Base Pack%	Bushel Capacity with Pack	
					Length	Width										
	A-H	024	Square	floor over bins	0.000	10.50	5.500	37.00	0.00	0.00	37.000	0.000	37.0	46.4	4.00	1,786
	A-H	025 U	Square	floor over bins	0.000	5.000	3.500	21.00	0.00	0.00	21.000	0.000	21.0	14.1	2.00	302
	A-H	025 L	Square	door in manlift well measure	0.000	5.000	3.500	18.00	0.00	0.00	18.000	0.000	18.0	14.1	2.00	259
	A-H	026	Square	floor over bins	0.000	5.000	3.500	39.00	0.00	0.00	39.000	0.000	39.0	14.1	2.00	561
	A-H	101	Square	floor over bins	0.000	10.00	9.500	44.00	0.00	0.00	44.000	0.000	44.0	76.4	5.50	3,547
	A-H	102 T	Square	floor over bins	0.000	10.50	9.500	44.00	0.00	0.00	44.000	0.000	44.0	80.2	5.50	3,723
	A-H	102 B	Square	44' to bottom	0.000	12.00	9.500	8.000	0.00	0.00	8.000	0.000	8.0	91.6	5.80	776
	A-H	103 T	Square	floor over bins	0.000	10.50	9.500	44.00	0.00	0.00	44.000	0.000	44.0	80.2	5.50	3,723
	A-H	103 B	Square	44' to bottom	0.000	12.00	9.500	8.000	0.00	0.00	8.000	0.000	8.0	91.6	5.80	776
	A-H	104	Square	floor over bins	0.000	10.00	9.500	44.00	0.00	0.00	44.000	0.000	44.0	76.4	5.50	3,547
	A-H	105 T	Square	floor over bins	0.000	10.50	9.500	44.00	0.00	0.00	44.000	0.000	44.0	80.2	5.50	3,723
	A-H	105 B	Square	44' to bottom	0.000	12.00	9.500	8.000	0.00	0.00	8.000	0.000	8.0	91.6	5.80	776
	A-H	106	Square	floor over bins	0.000	10.00	9.500	44.00	0.00	0.00	44.000	0.000	44.0	76.4	5.50	3,547
	A-H	107 T	Square	floor over bins	0.000	10.50	9.500	44.00	0.00	0.00	44.000	0.000	44.0	80.2	5.50	3,723
	A-H	107 B	Square	44' to bottom	0.000	14.00	9.500	8.000	0.00	0.00	8.000	0.000	8.0	106.9	6.20	908
	A-H	108 T	Square	floor over bins	0.000	10.50	9.500	44.00	0.00	0.00	44.000	0.000	44.0	80.2	5.50	3,723
	A-H	108 B	Square	44' to bottom	0.000	14.00	9.500	8.000	0.00	0.00	8.000	0.000	8.0	106.9	6.20	908
	A-H	109 T	Square	floor over bins	0.000	10.50	9.500	44.00	0.00	0.00	44.000	0.000	44.0	80.2	5.50	3,723
	A-H	109 B	Square	44' to bottom	0.000	14.00	9.500	8.000	0.00	0.00	8.000	0.000	8.0	106.9	6.20	908
	A-H	201	Square	floor over bins	0.000	15.50	11.50	52.00	0.00	0.00	52.000	0.000	52.0	143.3	6.80	7,959
	A-H	202 T	Square	floor over bins	0.000	16.00	11.50	44.00	0.00	0.00	44.000	0.000	44.0	147.9	6.80	6,951
	A-H	202 B	Square	44' to bottom	0.000	11.00	11.50	8.000	0.00	0.00	8.000	0.000	8.0	101.7	6.00	863
	A-H	203	Square	floor over bins	0.000	15.50	11.50	52.00	0.00	0.00	52.000	0.000	52.0	143.3	6.80	7,959

Section: A-H

NDPSC Bin Capacity Chart

Exam Date:09/23/2015

Fessenden Cooperative Association
 PO Box 126
 Fessenden, ND
 County:

Examiner: 2

Status	Section	Bin Number	Bin Type	Base Point	Diameter or Bu/Ft (Irreg.) Length	Width	Side wall	Add for Hopper	Ded. for Obst.	Effective Depth	Add for Peak	Depth for Capac.	Bushels per Foot	Base Pack%	Bushel Capacity with Pack
--------	---------	------------	----------	------------	---	-------	--------------	----------------------	----------------------	--------------------	--------------------	------------------------	------------------------	---------------	------------------------------

Section: A-H

A-H	204 T	Square	floor over bins	0.000	16.00	11.50	44.00	0.00	0.00	44.000	0.000	44.0	147.9	6.80	6,951
A-H	204 B	Square	44' to bottom	0.000	11.00	11.50	8.000	0.00	0.00	8.000	0.000	8.0	101.7	6.00	863
A-H	205	Square	floor over bins	0.000	15.50	11.50	52.00	0.00	0.00	52.000	0.000	52.0	143.3	6.80	7,959
A-H	206 T	Square	floor over bins	0.000	16.00	11.50	44.00	0.00	0.00	44.000	0.000	44.0	147.9	6.80	6,951
A-H	206 B	Square	44' to bottom	0.000	11.00	11.50	8.000	0.00	0.00	8.000	0.000	8.0	101.7	6.00	863
A-H	207	Square	floor over bins	0.000	15.50	11.50	52.00	0.00	0.00	52.000	0.000	52.0	143.3	6.80	7,959
A-H	208 T	Square	floor over bins	0.000	16.00	11.50	44.00	0.00	0.00	44.000	0.000	44.0	147.9	6.80	6,951
A-H	208 B	Square	44' to bottom	0.000	11.00	11.50	8.000	0.00	0.00	8.000	0.000	8.0	101.7	6.00	863
A-H	209	Square	floor over bins	0.000	15.50	11.50	52.00	0.00	0.00	52.000	0.000	52.0	143.3	6.80	7,959
A-H	210 U	Square	floor over bins	0.000	16.00	11.50	22.00	0.00	0.00	22.000	0.000	22.0	147.9	6.80	3,475
A-H	210 M	Square	floor over bins mrse thru	0.000	16.00	11.50	22.00	0.00	0.00	22.000	0.000	22.0	147.9	6.80	3,475
A-H	210L	Square	64' u-trough to floor part of	0.000	11.00	11.50	8.000	0.00	0.00	8.000	0.000	8.0	101.7	6.00	863
A-H	401	Peaked	top of sidewall	24.000	0.000	0.000	24.00	0.00	0.00	24.000	1.400	25.4	363.7	7.80	9,959
A-H	402	Peaked	top of sidewall	24.000	0.000	0.000	24.00	0.00	0.00	24.000	1.400	25.4	363.7	7.80	9,959
A-H	403	Peaked	top of sidewall	24.000	0.000	0.000	24.00	0.00	0.00	24.000	1.400	25.4	363.7	7.80	9,959

Bin count: 61

Facility: Harlow Section: A-H Total: **185,928**

To Even: **186,000**

Section: B-H

B-H	001	Irregular	work floor -8.1 x 8.1 with	51.600	0.000	0.000	36.50	0.00	0.00	36.500	0.000	36.5	51.6	4.50	1,968
B-H	002	Square	floor over bins	0.000	8.100	8.100	36.50	0.00	0.00	36.500	0.000	36.5	52.7	4.50	2,011
B-H	003	Irregular	work floor - 8.1 x 8.1 with	51.600	0.000	0.000	36.50	0.00	0.00	36.500	0.000	36.5	51.6	4.50	1,968
B-H	004	Square	floor over bins	0.000	8.100	8.100	36.50	0.00	0.00	36.500	0.000	36.5	52.7	4.50	2,011

Exam Date:09/23/2015

Fessenden Cooperative Association
 PO Box 126
 Fessenden, ND
 County:

Examiner: 2

Status	Section	Bin Number	Bin Type	Base Point	Diameter or Bu/Ft (Irreg.)		Side wall	Add for Hopper	Ded. for Obst.	Effective Depth	Add for Peak	Depth for Capac.	Bushels per Foot	Base Pack%	Bushel Capacity with Pack	
					Length	Width										
	B-H	005	Square	floor over bins	0.000	8.100	8.100	36.50	0.00	0.00	36.500	0.000	36.5	52.7	4.50	2,011
	B-H	006	Square	floor over bins	0.000	8.100	8.100	36.50	0.00	0.00	36.500	0.000	36.5	52.7	4.50	2,011
	B-H	007	Square	floor over bins	0.000	8.100	8.100	36.50	0.00	0.00	36.500	0.000	36.5	52.7	4.50	2,011
	B-H	008	Irregular	floor over bins 8.1 x 8.1	50.400	0.000	0.000	36.50	0.00	0.00	36.500	0.000	36.5	50.4	4.50	1,923
	B-H	009	Square	floor over bins	0.000	8.100	8.100	36.50	0.00	0.00	36.500	0.000	36.5	52.7	4.50	2,011
	B-H	010	Square	floor over bins	0.000	8.100	8.100	27.00	0.00	0.00	27.000	0.000	27.0	52.7	4.50	1,487
	B-H	011	Square	floor over bins	0.000	8.100	8.100	27.00	0.00	0.00	27.000	0.000	27.0	52.7	4.50	1,487
	B-H	012	Square	floor over bins	0.000	8.100	8.100	27.00	0.00	0.00	27.000	0.000	27.0	52.7	4.50	1,487
	B-H	013	Square	floor over bins	0.000	8.100	8.100	27.00	0.00	0.00	27.000	0.000	27.0	52.7	4.50	1,487
	B-H	014	Peaked	top of sidewall	18.000	0.000	0.000	21.00	0.00	0.00	21.000	1.100	22.1	204.6	6.00	4,793
	B-H	015	Peaked	top of sidewall	18.000	0.000	0.000	21.00	0.00	0.00	21.000	1.100	22.1	204.6	6.00	4,793
	B-H	016	Peaked	top of sidewall	15.000	0.000	0.000	35.00	0.00	0.00	35.000	0.900	35.9	142.1	5.50	5,382
	B-H	017	Peaked	top of sidewall	15.000	0.000	0.000	35.00	0.00	0.00	35.000	0.900	35.9	142.1	5.50	5,382
	B-H	018	Peaked	top of sidewall	30.000	0.000	0.000	26.00	0.00	0.00	26.000	1.800	27.8	568.2	9.00	17,218
	B-H	019	Peaked	top of sidewall	30.000	0.000	0.000	26.00	0.00	0.00	26.000	1.800	27.8	568.2	9.00	17,218
	B-H	020	Peaked	top of sidewall	14.000	0.000	0.000	10.70	2.00	0.00	12.700	0.800	13.5	123.7	5.50	1,762
	B-H	021	Peaked	top of sidewall	16.000	0.000	0.000	15.00	2.00	0.00	17.000	1.000	18.0	161.6	5.80	3,078
	B-H	022	Peaked	top of sidewall	16.000	0.000	0.000	20.00	2.00	0.00	22.000	1.000	23.0	161.6	5.80	3,933
	B-H	023	Peaked	top of sidewall	16.000	0.000	0.000	20.00	2.00	0.00	22.000	1.000	23.0	161.6	5.80	3,933

Bin count: 23

Facility: Harlow Section: B-H Total: **91,365**

To Even: **92,000**

Exam Date:09/23/2015

Fessenden Cooperative Association

Page: 11

Examiner: 2

PO Box 126
Fessenden , ND
County:

Status	Section	Bin Number	Bin Type	Base Point	Diameter or Bu/Ft (Irreg).		Side wall	Add for Hopper	Ded. for Obst.	Effective Depth	Add for Peak	Depth for Capac.	Bushels per Foot	Base Pack%	Bushel Capacity with Pack	
					Length	Width										
	C	001 T	Square	work floor	0.000	5.300	4.200	20.00	0.00	0.00	20.000	0.000	20.0	17.9	2.00	365
	C	001 B	Square	work floor - top 20'	0.000	10.80	4.200	26.00	0.00	0.00	26.000	0.000	26.0	36.5	3.00	977
	C	002	Square	work floor	0.000	7.000	4.400	45.00	0.00	0.00	45.000	0.000	45.0	24.8	2.50	1,144
	C	003	Square	work floor	0.000	10.80	4.100	46.00	0.00	0.00	46.000	0.000	46.0	35.6	3.00	1,687
	C	004	Square	work floor	0.000	11.40	9.000	63.00	0.00	0.00	63.000	0.000	63.0	82.5	5.50	5,484
	C	005	Square	work floor	0.000	11.40	5.900	46.00	0.00	0.00	46.000	0.000	46.0	54.1	4.50	2,601
	C	008	Square	work floor	0.000	7.000	5.800	45.00	0.00	0.00	45.000	0.000	45.0	32.6	2.50	1,504
	C	009	Square	work floor	0.000	11.40	5.800	46.00	0.00	0.00	46.000	0.000	46.0	53.2	4.50	2,557
	C	010	Square	work floor	0.000	11.40	8.900	64.00	0.00	0.00	64.000	0.000	64.0	81.6	5.50	5,509
	C	011	Square	work floor	0.000	8.900	7.000	45.00	0.00	0.00	45.000	0.000	45.0	50.1	4.50	2,356
	C	013	Square	work floor	0.000	7.000	5.800	45.00	0.00	0.00	45.000	0.000	45.0	32.6	2.50	1,504
	C	014 T	Irregular	work floor 8.9 x 7 less	16.300	0.000	0.000	15.00	0.00	0.00	15.000	0.000	15.0	16.3	2.00	250
	C	014 B	Square	work floor - top 15'	0.000	8.900	7.000	30.00	0.00	0.00	30.000	0.000	30.0	50.1	4.50	1,571
	C	015	Square	work floor	0.000	11.40	8.900	64.00	0.00	0.00	64.000	0.000	64.0	81.6	5.50	5,509
	C	016	Square	work floor	0.000	11.40	5.800	46.00	0.00	0.00	46.000	0.000	46.0	53.2	4.50	2,557
	C	017	Square	work floor	0.000	11.40	5.900	46.00	0.00	0.00	46.000	0.000	46.0	54.1	4.50	2,601
	C	018	Square	work floor	0.000	7.000	4.400	45.00	0.00	0.00	45.000	0.000	45.0	24.8	2.50	1,144
	C	020	Square	work floor	0.000	5.300	4.200	20.00	0.00	0.00	20.000	0.000	20.0	17.9	2.00	365
	C	022	Square	work floor	0.000	11.40	9.000	63.00	0.00	0.00	63.000	0.000	63.0	82.5	5.50	5,484
	C	101	Square	work floor	0.000	5.000	3.600	36.00	0.00	0.00	36.000	0.000	36.0	14.5	2.00	532
	C	102	Square	work floor	0.000	9.400	5.500	36.50	0.00	0.00	36.500	0.000	36.5	41.6	3.50	1,571
	C	103	Square	work floor	0.000	9.400	3.500	36.00	0.00	0.00	36.000	0.000	36.0	26.4	2.50	974
	C	104 T	Square	work floor	0.000	9.400	4.500	37.00	0.00	0.00	37.000	0.000	37.0	34.0	2.50	1,289

Section: C

Exam Date:09/23/2015

Fessenden Cooperative Association

Page: 12

Examiner: 2

PO Box 126
Fessenden, ND
County:

Status	Section	Bin Number	Bin Type	Base Point	Diameter or Bu/Ft (Irreg).		Side wall	Add for Hopper	Ded. for Obst.	Effective Depth	Add for Peak	Depth for Capac.	Bushels per Foot	Base Pack%	Bushel Capacity with Pack	
					Length	Width										
	Section: C															
	C	104 B	Square	work floor - top 37'	0.000	10.20	9.400	18.00	0.00	0.00	18.000	0.000	18.0	77.1	5.50	1,464
	C	105	Square	work floor	0.000	9.400	5.500	36.50	0.00	0.00	36.500	0.000	36.5	41.6	3.50	1,571
	C	106 T	Square	work floor	0.000	9.600	4.500	37.00	0.00	0.00	37.000	0.000	37.0	34.7	3.00	1,323
	C	106 B	Square	work floor - top 37'	0.000	10.20	9.600	18.00	0.00	0.00	18.000	0.000	18.0	78.7	5.50	1,495
	C	107 T	Square	work floor	0.000	9.400	4.500	37.00	0.00	0.00	37.000	0.000	37.0	34.0	2.50	1,289
	C	107 B	Square	work floor - top 37'	0.000	10.20	9.400	18.00	0.00	0.00	18.000	0.000	18.0	77.1	5.50	1,464
	C	108	Square	work floor	0.000	9.600	5.500	36.50	0.00	0.00	36.500	0.000	36.5	42.4	3.50	1,602
	C	109 T	Square	work floor	0.000	9.600	4.500	37.00	0.00	0.00	37.000	0.000	37.0	34.7	3.00	1,323
	C	109 B	Square	work floor - top 37'	0.000	10.20	9.600	18.00	0.00	0.00	18.000	0.000	18.0	78.7	5.50	1,495
	C	110	Square	work floor	0.000	9.600	6.400	37.00	0.00	0.00	37.000	0.000	37.0	49.4	4.20	1,905
	C	111	Square	work floor	0.000	9.600	5.500	36.50	0.00	0.00	36.500	0.000	36.5	42.4	3.50	1,602
	C	112 T	Square	work floor	0.000	9.400	4.500	37.00	0.00	0.00	37.000	0.000	37.0	34.0	2.50	1,289
	C	112 B	Square	work floor - top 37'	0.000	10.20	9.400	17.00	0.00	0.00	17.000	0.000	17.0	77.1	5.50	1,383
	C	113	Square	work floor	0.000	9.600	6.400	37.00	0.00	0.00	37.000	0.000	37.0	49.4	4.20	1,905
	C	114	Square	work floor	0.000	9.400	5.500	35.00	0.00	0.00	35.000	0.000	35.0	41.6	3.50	1,507
	C	115 T	Square	work floor	0.000	9.400	4.500	37.00	0.00	0.00	37.000	0.000	37.0	34.0	2.50	1,289
	C	115 B	Square	work floor - top 37'	0.000	10.20	9.400	17.00	0.00	0.00	17.000	0.000	17.0	77.1	5.50	1,383
	C	116	Square	work floor	0.000	9.400	6.400	36.00	0.00	0.00	36.000	0.000	36.0	48.4	4.20	1,815
	C	117	Square	work floor	0.000	9.400	5.500	35.00	0.00	0.00	35.000	0.000	35.0	41.6	3.50	1,507
	C	118	Square	work floor	0.000	9.400	6.400	36.00	0.00	0.00	36.000	0.000	36.0	48.4	4.20	1,815
	C	201 T	Square	work floor	0.000	15.20	13.20	58.50	0.00	0.00	58.500	0.000	58.5	161.3	7.00	10,097
	C	201 B	Square	work floor - top 58.5'	0.000	13.20	12.70	7.000	0.00	0.00	7.000	0.000	7.0	134.8	6.50	1,005
	C	202 T	Square	work floor	0.000	15.20	13.20	58.50	0.00	0.00	58.500	0.000	58.5	161.3	7.00	10,097

Exam Date:09/23/2015

Fessenden Cooperative Association

Page: 13

Examiner: 2

PO Box 126
Fessenden , ND
County:

Status	Section	Bin Number	Bin Type	Base Point	Diameter or Bu/Ft (Irreg).		Side wall	Add for Hopper	Ded. for Obst.	Effective Depth	Add for Peak	Depth for Capac.	Bushels per Foot	Base Pack%	Bushel Capacity with Pack
					Length	Width									
C	202 B	Square	work floor - top 58.5'	0.000	13.20	12.80	7.000	0.00	0.00	7.000	0.000	7.0	135.8	6.50	1,013
C	203 T	Square	work floor	0.000	15.20	13.60	58.50	0.00	0.00	58.500	0.000	58.5	166.2	7.00	10,404
C	203 B	Square	work floor - top 58.5'	0.000	13.60	12.80	7.000	0.00	0.00	7.000	0.000	7.0	139.9	6.80	1,046
C	204 T	Square	work floor	0.000	13.60	3.100	31.00	0.00	0.00	31.000	0.000	31.0	33.9	2.50	1,077
C	204 M	Square	work floor - top 31'	0.000	15.20	13.60	27.50	0.00	0.00	27.500	0.000	27.5	166.2	7.00	4,891
C	204B	Square	work floor - top & mddle	0.000	13.60	12.70	7.000	0.00	0.00	7.000	0.000	7.0	138.8	6.50	1,035
C	205	Square	work floor	0.000	13.60	11.70	31.00	0.00	0.00	31.000	0.000	31.0	127.9	6.50	4,223
C	206 T	Square	work floor	0.000	15.20	13.60	58.50	0.00	0.00	58.500	0.000	58.5	166.2	7.00	10,404
C	206 B	Square	work floor - top 58.5'	0.000	13.60	12.70	7.000	0.00	0.00	7.000	0.000	7.0	138.8	6.50	1,035
C	207 T	Square	work floor	0.000	15.20	13.60	58.50	0.00	0.00	58.500	0.000	58.5	166.2	7.00	10,404
C	207 B	Square	work floor - top 58.5'	0.000	13.60	12.80	7.000	0.00	0.00	7.000	0.000	7.0	139.9	6.80	1,046
C	208 T	Square	work floor	0.000	15.20	13.60	58.50	0.00	0.00	58.500	0.000	58.5	166.2	7.00	10,404
C	208 B	Square	work floor - top 58.5'	0.000	13.60	12.80	7.000	0.00	0.00	7.000	0.000	7.0	139.9	6.80	1,046
C	209 T	Square	work floor	0.000	13.60	3.300	31.00	0.00	0.00	31.000	0.000	31.0	36.1	3.00	1,153
C	209 M	Square	work floor - top 31'	0.000	15.20	13.60	27.50	0.00	0.00	27.500	0.000	27.5	166.2	7.00	4,891
C	209B	Square	work floor - top & mddle	0.000	13.60	12.70	7.000	0.00	0.00	7.000	0.000	7.0	138.8	6.50	1,035
C	210	Square	work floor	0.000	13.60	11.50	31.00	0.00	0.00	31.000	0.000	31.0	125.7	6.50	4,150
C	211 T	Square	work floor	0.000	15.20	13.50	58.50	0.00	0.00	58.500	0.000	58.5	165.0	7.00	10,329
C	211 B	Square	work floor - top 58.5'	0.000	13.50	12.70	7.000	0.00	0.00	7.000	0.000	7.0	137.8	6.50	1,028
C	212 T	Square	work floor	0.000	15.20	13.50	58.50	0.00	0.00	58.500	0.000	58.5	165.0	7.00	10,329
C	212 B	Square	work floor - top 58.5'	0.000	13.50	12.80	7.000	0.00	0.00	7.000	0.000	7.0	138.9	6.50	1,035
C	213 T	Square	work floor	0.000	15.20	13.50	58.50	0.00	0.00	58.500	0.000	58.5	165.0	7.00	10,329
C	213 B	Square	work floor - top 58.5'	0.000	13.50	12.80	7.000	0.00	0.00	7.000	0.000	7.0	138.9	6.50	1,035

Section: C

Exam Date:09/23/2015

Fessenden Cooperative Association
PO Box 126
Fessenden , ND
County:

Page: 14

Status	Section	Bin Number	Bin Type	Base Point	Diameter or Bu/Ft (Irreg.) Length	Width	Side wall	Add for Hopper	Ded. for Obst.	Effective Depth	Add for Peak	Depth for Capac.	Bushels per Foot	Base Pack%	Bushel Capacity with Pack	
	Section: C															
	C	214	Square	work floor	0.000	13.20	11.80	31.00	0.00	0.00	31.000	0.000	31.0	125.2	6.50	4,133
	C	215 T	Square	work floor	0.000	13.20	3.000	31.00	0.00	0.00	31.000	0.000	31.0	31.8	2.50	1,011
	C	215 M	Square	work floor - top 31'	0.000	15.20	13.20	27.50	0.00	0.00	27.500	0.000	27.5	161.3	7.00	4,747
	C	215B	Square	work floor - top & mddle	0.000	13.20	12.80	7.000	0.00	0.00	7.000	0.000	7.0	135.8	6.50	1,013
	C	216 T	Square	work floor	0.000	15.20	13.20	58.50	0.00	0.00	58.500	0.000	58.5	161.3	7.00	10,097
	C	216 B	Square	work floor - top 58.5'	0.000	13.20	12.70	7.000	0.00	0.00	7.000	0.000	7.0	134.8	6.50	1,005
	C	217 T	Square	work floor	0.000	13.50	3.300	31.00	0.00	0.00	31.000	0.000	31.0	35.8	3.00	1,143
	C	217 M	Square	work floor - top 31'	0.000	15.20	13.50	27.50	0.00	0.00	27.500	0.000	27.5	165.0	7.00	4,856
	C	217B	Square	work floor - top & mddle	0.000	13.50	12.70	7.000	0.00	0.00	7.000	0.000	7.0	137.8	6.50	1,028
	C	218	Square	work floor	0.000	13.50	11.50	31.00	0.00	0.00	31.000	0.000	31.0	124.8	6.50	4,120

Bin count: 79

Facility: Heimdal Section: C Total: **237,655**To Even: **238,000****Section: C-H**

C-H	002A	Peaked	top of sidewall	24.000	0.000	0.000	52.30	0.00	0.00	52.300	1.400	53.7	363.7	7.80	21,054
C-H	003	Peaked	top of sidewall	35.900	0.000	0.000	53.70	0.00	0.00	53.700	2.200	55.9	813.7	10.0	50,035
C-H	004	Peaked	top of sidewall	35.900	0.000	0.000	53.70	0.00	0.00	53.700	2.200	55.9	813.7	10.0	50,035

Bin count: 3

Facility: Harlow Section: C-H Total: **121,124**To Even: **122,000**

Exam Date:09/23/2015

Fessenden Cooperative Association

Page: 15

Examiner: 2

PO Box 126
Fessenden, ND
County:

Status	Section	Bin Number	Bin Type	Base Point	Diameter or Bu/Ft (Irreg.)		Side wall	Add for Hopper	Ded. for Obst.	Effective Depth	Add for Peak	Depth for Capac.	Bushels per Foot	Base Pack%	Bushel Capacity with Pack	
					Length	Width										
D	001		Irregular	top of slab - rectangle- bulk	255.63	17.83	17.83	38.00	3.00	0.50	40.500	0.000	40.5	255.6	7.00	11,078
D	002		Irregular	top of slab- rectangular	71.210	9.412	9.412	88.50	1.60	0.50	89.600	0.000	89.6	71.2	5.20	6,712
D	003		Irregular	top of slab- rectangular	71.210	9.412	9.412	88.50	1.60	0.50	89.600	0.000	89.6	71.2	5.20	6,712
D	004		Irregular	top of slab- rectangular	147.65	13.55	13.55	88.50	2.70	0.50	90.700	0.000	90.7	147.6	6.80	14,303
D	005		Irregular	top of slab- rectangular	169.08	14.50	14.50	80.50	2.60	0.50	82.600	0.000	82.6	169.0	7.00	14,944
D	006		Irregular	top of slab- rectangular	169.08	14.50	14.50	80.50	2.60	0.50	82.600	0.000	82.6	169.0	7.00	14,944
D	007		Irregular	top of slab- rectangular	96.980	10.98	10.98	80.00	2.30	0.50	81.800	0.000	81.8	96.9	6.00	8,409
D	008		Irregular	top of slab - rectangular	169.08	14.50	14.50	80.50	2.60	0.50	82.600	0.000	82.6	169.0	7.00	14,944
D	009		Irregular	top of slab- rectangular	169.08	14.50	14.50	80.50	2.60	0.50	82.600	0.000	82.6	169.0	7.00	14,944
D	010		Irregular	top of slab - 1/2 stice	93.250	10.77	10.77	140.5	0.00	4.50	136.00	0.000	136.0	93.2	5.80	13,418
D	011		Round	top of slab	36.000	0.000	0.000	140.5	0.00	4.37	136.13	0.000	136.1	818.2	10.0	122,493
D	012		Round	top of slab	36.000	0.000	0.000	140.5	0.00	4.37	136.13	0.000	136.1	818.2	10.0	122,493
D	013		Irregular	top of slab - interstice	206.35	16.02	16.02	140.5	0.00	6.50	134.00	0.000	134.0	206.3	7.00	29,587
D	014		Round	top of slab	36.000	0.000	0.000	140.5	0.00	4.37	136.13	0.000	136.1	818.2	10.0	122,493
D	015		Round	top of slab	36.000	0.000	0.000	140.5	0.00	4.37	136.13	0.000	136.1	818.2	10.0	122,493
D	016		Irregular	top of slab - interstice	206.35	16.02	16.02	140.5	0.00	6.50	134.00	0.000	134.0	206.3	7.00	29,587
D	017		Round	top of slab	36.000	0.000	0.000	140.5	0.00	4.37	136.13	0.000	136.1	818.2	10.0	122,493
D	018		Round	top of slab	36.000	0.000	0.000	140.5	0.00	4.37	136.13	0.000	136.1	818.2	10.0	122,493
D	019		Irregular	top of slab - interstice	206.35	16.02	16.02	140.5	0.00	6.50	134.00	0.000	134.0	206.3	7.00	29,587
D	020		Round	top of slab	36.000	0.000	0.000	140.5	0.00	4.37	136.13	0.000	136.1	818.2	10.0	122,493
D	021		Round	top of slab	36.000	0.000	0.000	140.5	0.00	4.37	136.13	0.000	136.1	818.2	10.0	122,493
D	022		Irregular	top of slab - interstice	206.35	16.02	16.02	140.5	0.00	6.50	134.00	0.000	134.0	206.3	7.00	29,587
D	023		Round	top of slab	36.000	0.000	0.000	140.5	0.00	4.37	136.13	0.000	136.1	818.2	10.0	122,493

Section: D

Exam Date:09/23/2015

Fessenden Cooperative Association

Page: 16

Examiner: 2

PO Box 126
Fessenden, ND
County:

Status	Section	Bin Number	Bin Type	Base Point	Diameter or Bu/Ft (Irreg).		Side wall	Add for Hopper	Ded. for Obst.	Effective Depth	Add for Peak	Depth for Capac.	Bushels per Foot	Base Pack%	Bushel Capacity with Pack	
					Length	Width										
	Section: D															
	D	024	Round	top of slab	36.000	0.000	0.000	140.5	0.00	4.37	136.13	0.000	136.1	818.2	10.0	122,493
	D	025	Round	top of slab	76.000	0.000	0.000	140.5	0.00	3.72	136.78	0.000	136.8	3646.7	10.0	548,756
	D	026	Round	top of slab	76.000	0.000	0.000	140.5	0.00	3.72	136.78	0.000	136.8	3646.7	10.0	548,756
Bin count: 26										Facility: Hamberg Section: D Total:					2,561,198	
										To Even:					2,562,000	

Section: E-H

E-H	001	Round	top of slab	24.000	0.000	0.000	123.0	0.00	0.00	123.00	0.000	123.0	363.7	7.80	48,224
E-H	002	Round	top of slab	24.000	0.000	0.000	123.0	0.00	0.00	123.00	0.000	123.0	363.7	7.80	48,224
E-H	003	Round	top of slab	24.000	0.000	0.000	123.0	0.00	0.00	123.00	0.000	123.0	363.7	7.80	48,224
E-H	004	Round	top of slab	24.000	0.000	0.000	123.0	0.00	0.00	123.00	0.000	123.0	363.7	7.80	48,224
E-H	005	Irregular	top of slab	24.300	0.000	0.000	92.00	0.00	0.00	92.000	0.000	92.0	24.3	2.50	2,292
E-H	006	Irregular	top of slab	24.300	0.000	0.000	87.00	0.00	0.00	87.000	0.000	87.0	24.3	2.50	2,167
E-H	007	Irregular	top of slab	34.600	0.000	0.000	95.50	0.00	0.00	95.500	0.000	95.5	34.6	3.00	3,403
E-H	008	Irregular	top of slab	34.600	0.000	0.000	95.50	0.00	0.00	95.500	0.000	95.5	34.6	3.00	3,403
E-H	009	Irregular	top of slab	58.700	0.000	0.000	94.50	0.00	0.00	94.500	0.000	94.5	58.7	4.80	5,813
E-H	010	Irregular	top of slab 10.6' x 8.5'	71.500	0.000	0.000	95.00	0.00	0.00	95.000	0.000	95.0	71.5	5.20	7,146
E-H	011	Irregular	top of slab	58.700	0.000	0.000	94.50	0.00	0.00	94.500	0.000	94.5	58.7	4.80	5,813
E-H	012	Irregular	top of slab	30.800	0.000	0.000	95.50	0.00	0.00	95.500	0.000	95.5	30.8	2.50	3,015
E-H	013	Irregular	top of slab	30.800	0.000	0.000	95.50	0.00	0.00	95.500	0.000	95.5	30.8	2.50	3,015
E-H	014	Irregular	top of slab	151.50	0.000	0.000	48.00	0.00	0.00	48.000	0.000	48.0	151.5	6.80	7,766
E-H	T1	Peaked	top of slab	16.000	0.000	0.000	15.00	2.00	0.00	17.000	1.000	18.0	161.6	5.80	3,078
E-H	T2	Peaked	top of slab	16.000	0.000	0.000	15.00	2.00	0.00	17.000	1.000	18.0	161.6	5.80	3,078

NDPSC Bin Capacity Chart

Exam Date:09/23/2015

Fessenden Cooperative Association
PO Box 126
Fessenden, ND
County:

Page: 17

Status	Section	Bin Number	Bin Type	Base Point	Diameter or Bu/Ft (Irreg).		Side wall	Add for Hopper	Ded. for Obst.	Effective Depth	Add for Peak	Depth for Capac.	Bushels per Foot	Base Pack%	Bushel Capacity with Pack	
	E-H	T3	Peaked	top of slab	16.000	0.000	0.000	20.00	2.00	0.00	22.000	1.000	23.0	161.6	5.80	3,933
	E-H	T4	Peaked	top of slab	16.000	0.000	0.000	20.00	2.00	0.00	22.000	1.000	23.0	161.6	5.80	3,933
	E-H	T5	Peaked	top of slab	16.000	0.000	0.000	15.00	2.00	0.00	17.000	1.000	18.0	161.6	5.80	3,078

Bin count: 19

Facility: Harlow Section: E-H Total: 253,829

To Even: 254,000

Section: G

G	001	Square	work floor	0.000	9.300	3.400	15.00	0.00	0.00	15.000	0.000	15.0	25.4	2.50	391
G	002	Square	work floor	0.000	5.000	3.400	29.00	0.00	0.00	29.000	0.000	29.0	13.7	2.00	405
G	003	Irregular	work floor	111.80	0.000	0.000	9.000	0.00	0.00	9.000	0.000	9.0	111.8	6.20	1,068
G	004	Square	work floor- flat bottom	0.000	10.10	9.300	48.00	0.00	0.00	48.000	0.000	48.0	75.5	5.50	3,823
G	005	Square	work floor - 8' hoper	0.000	10.00	9.300	44.30	0.00	0.00	44.300	0.000	44.3	74.8	5.50	3,496
G	006	Square	work floor	0.000	9.500	6.200	29.00	0.00	0.00	29.000	0.000	29.0	47.3	4.00	1,427
G	008	Square	work floor	0.000	10.10	9.500	48.00	0.00	0.00	48.000	0.000	48.0	77.1	5.50	3,905
G	009	Square	work floor	0.000	9.500	6.300	29.00	0.00	0.00	29.000	0.000	29.0	48.1	4.20	1,454
G	010	Square	work floor	0.000	10.10	9.300	45.00	0.00	0.00	45.000	0.000	45.0	75.5	5.50	3,585
G	011	Square	work floor - hoppr floor	0.000	10.00	9.500	44.30	0.00	0.00	44.300	0.000	44.3	76.4	5.50	3,571
G	012	Square	work floor	0.000	9.300	6.300	28.00	0.00	0.00	28.000	0.000	28.0	47.1	4.00	1,372
G	013	Square	work floor - hopped	0.000	10.00	9.300	44.30	0.00	0.00	44.300	0.000	44.3	74.8	5.50	3,496
G	015	Square	work floor	0.000	9.300	6.200	28.00	0.00	0.00	28.000	0.000	28.0	46.4	4.00	1,351
G	102 T	Irregular	work floor 9.3x4.8	35.900	0.000	0.000	15.00	0.00	0.00	15.000	0.000	15.0	35.9	3.00	555
G	102 B	Irregular	work floor - top 15'	35.900	0.000	0.000	14.00	0.00	0.00	14.000	0.000	14.0	35.9	3.00	518
G	104	Square	work floor	0.000	11.10	9.300	45.00	0.00	0.00	45.000	0.000	45.0	83.0	5.50	3,940

Exam Date:09/23/2015

Fessenden Cooperative Association

Page: 18

Examiner: 2

PO Box 126
Fessenden, ND
County:

Status	Section	Bin Number	Bin Type	Base Point	Diameter or Bu/Ft (Irreg).		Side wall	Add for Hopper	Ded. for Obst.	Effective Depth	Add for Peak	Depth for Capac.	Bushels per Foot	Base Pack%	Bushel Capacity with Pack	
					Length	Width										
Section: G																
G	105		Square	work floor	0.000	11.00	9.300	45.00	0.00	0.00	45.000	0.000	45.0	82.2	5.50	3,902
G	106		Square	work floor	0.000	9.500	4.800	28.00	0.00	0.00	28.000	0.000	28.0	36.7	3.00	1,059
G	108		Square	work floor	0.000	11.10	9.500	45.00	0.00	0.00	45.000	0.000	45.0	84.8	5.80	4,037
G	109		Square	work floor	0.000	9.500	5.700	28.00	0.00	0.00	28.000	0.000	28.0	43.5	3.50	1,261
G	110		Square	work floor	0.000	11.10	9.300	45.00	0.00	0.00	45.000	0.000	45.0	83.0	5.50	3,940
G	111		Square	work floor	0.000	11.00	9.500	45.00	0.00	0.00	45.000	0.000	45.0	84.0	5.80	3,999
G	112		Square	work floor	0.000	9.300	5.700	27.00	0.00	0.00	27.000	0.000	27.0	42.6	3.50	1,190
G	113		Square	work floor	0.000	11.00	9.300	45.00	0.00	0.00	45.000	0.000	45.0	82.2	5.50	3,902
G	115		Square	work floor	0.000	9.300	4.800	27.00	0.00	0.00	27.000	0.000	27.0	35.9	3.00	998
G	201 T		Square	top of cribbing	0.000	14.00	13.20	41.00	0.00	0.00	41.000	0.000	41.0	148.6	6.80	6,507
G	201 B		Square	top of cribbing - top 41'	0.000	13.20	13.10	10.00	0.00	0.00	10.000	0.000	10.0	139.0	6.50	1,480
G	202 T		Square	top of cribbing -	0.000	14.00	13.10	41.00	0.00	0.00	41.000	0.000	41.0	147.4	6.80	6,454
G	202 B		Square	top of cribbing - top 41'	0.000	13.10	13.10	10.00	0.00	0.00	10.000	0.000	10.0	138.0	6.50	1,470
G	203 T		Square	top of cribbing -	0.000	14.00	13.10	41.00	0.00	0.00	41.000	0.000	41.0	147.4	6.80	6,454
G	203 B		Square	top of cribbing - top 41'	0.000	13.10	13.10	10.00	0.00	0.00	10.000	0.000	10.0	138.0	6.50	1,470
G	205 T		Square	top of cribbing -	0.000	14.20	13.10	41.00	0.00	0.00	41.000	0.000	41.0	149.5	6.80	6,547
G	205 B		Square	top of cribbing - top 41'	0.000	13.10	12.10	10.00	0.00	0.00	10.000	0.000	10.0	127.4	6.50	1,357
G	206 T		Square	top of cribbing -	0.000	14.20	13.10	41.00	0.00	0.00	41.000	0.000	41.0	149.5	6.80	6,547
G	206 B		Square	top of cribbing - top 41'	0.000	13.10	12.10	10.00	0.00	0.00	10.000	0.000	10.0	127.4	6.50	1,357
G	207 T		Square	top of cribbing -	0.000	14.20	13.20	41.00	0.00	0.00	41.000	0.000	41.0	150.7	6.80	6,599
G	207 B		Square	top of cribbing - top 41'	0.000	13.20	12.10	10.00	0.00	0.00	10.000	0.000	10.0	128.4	6.50	1,367
G	301		Peaked	top of sidewall	15.000	0.000	0.000	43.90	0.00	0.00	43.900	0.900	44.8	142.1	5.50	6,716
G	302		Peaked	top of sidewall	24.000	0.000	0.000	54.00	0.00	0.00	54.000	1.400	55.4	363.7	7.80	21,721

Exam Date:09/23/2015

Fessenden Cooperative Association

Page: 19

Examiner: 2

PO Box 126
Fessenden, ND
County:

Status	Section	Bin Number	Bin Type	Base Point	Diameter or Bu/Ft (Irreg).		Side wall	Add for Hopper	Ded. for Obst.	Effective Depth	Add for Peak	Depth for Capac.	Bushels per Foot	Base Pack%	Bushel Capacity with Pack	
					Length	Width										
G	303	Peaked	top of sidewall		24.000	0.000	0.000	54.00	0.00	0.00	54.000	1.400	55.4	363.7	7.80	21,721
G	304	Peaked	top of sidewall		24.000	0.000	0.000	39.00	0.00	0.00	39.000	1.400	40.4	363.7	7.80	15,839
G	305	Peaked	top of sidewall		15.000	0.000	0.000	15.00	2.00	0.00	17.000	0.900	17.9	142.1	5.50	2,684
G	306	Peaked	top of sidewall		41.800	0.000	0.000	82.80	0.00	0.00	82.800	2.500	85.3	1103.1	10.0	103,503
G	307	Peaked	top of sidewall		41.800	0.000	0.000	82.80	0.00	0.00	82.800	2.500	85.3	1103.1	10.0	103,503
G	308	Peaked	top of sidewall		41.800	0.000	0.000	82.80	0.00	0.00	82.800	2.500	85.3	1103.1	10.0	103,503
G	401	Peaked	top of sidewall need more		13.600	0.000	0.000	13.60	2.00	0.00	15.600	0.800	16.4	116.8	5.20	2,016
G	402	Peaked	top of sidewall need more		13.600	0.000	0.000	13.60	2.00	0.00	15.600	0.800	16.4	116.8	5.20	2,016
G	403	Peaked	top of sidewall need more		13.600	0.000	0.000	13.60	2.00	0.00	15.600	0.800	16.4	116.8	5.20	2,016
G	404	Peaked	top of sidewall need more		16.000	0.000	0.000	15.00	2.00	0.00	17.000	1.000	18.0	161.6	5.80	3,078
G	405	Peaked	top of sidewall need more		16.000	0.000	0.000	15.00	2.00	0.00	17.000	1.000	18.0	161.6	5.80	3,078
G	406	Peaked	top of sidewall need more		16.000	0.000	0.000	15.00	2.00	0.00	17.000	1.000	18.0	161.6	5.80	3,078
G	407	Peaked	top of sidewall need more		16.000	0.000	0.000	15.00	2.00	0.00	17.000	1.000	18.0	161.6	5.80	3,078
G	408	Peaked	top of sidewall need more		16.000	0.000	0.000	20.00	2.00	0.00	22.000	1.000	23.0	161.6	5.80	3,933
G	409	Peaked	top of sidewall need more		16.000	0.000	0.000	20.00	2.00	0.00	22.000	1.000	23.0	161.6	5.80	3,933
G	410	Peaked	top of sidewall need more		16.000	0.000	0.000	20.00	2.00	0.00	22.000	1.000	23.0	161.6	5.80	3,933
G	411	Peaked	top of sidewall need more		16.000	0.000	0.000	20.00	2.00	0.00	22.000	1.000	23.0	161.6	5.80	3,933
G	412	Peaked	top of sidewall need more		16.000	0.000	0.000	20.00	2.00	0.00	22.000	1.000	23.0	161.6	5.80	3,933
G	413	Peaked	top of sidewall need more		16.000	0.000	0.000	20.00	2.00	0.00	22.000	1.000	23.0	161.6	5.80	3,933
G	414	Peaked	top of sidewall need more		16.000	0.000	0.000	20.00	2.00	0.00	22.000	1.000	23.0	161.6	5.80	3,933
G	415	Peaked	top of sidewall need more		16.000	0.000	0.000	20.00	2.00	0.00	22.000	1.000	23.0	161.6	5.80	3,933
G	416	Peaked	top of sidewall need more		16.000	0.000	0.000	20.00	2.00	0.00	22.000	1.000	23.0	161.6	5.80	3,933
G	417	Peaked	top of sidewall need more		16.000	0.000	0.000	20.00	2.00	0.00	22.000	1.000	23.0	161.6	5.80	3,933

Section: G

Exam Date:09/23/2015

Fessenden Cooperative Association

Page: 20

Examiner: 2

PO Box 126
Fessenden , ND
County:

Status	Section	Bin Number	Bin Type	Base Point	Diameter or Bu/Ft (Irreg.)		Side wall	Add for Hopper	Ded. for Obst.	Effective Depth	Add for Peak	Depth for Capac.	Bushels per Foot	Base Pack%	Bushel Capacity with Pack
					Length	Width									

Section: G

G	418	Peaked	top of sidewall need more	16.000	0.000	0.000	20.00	2.00	0.00	22.000	1.000	23.0	161.6	5.80	3,933
G	419	Peaked	top of sidewall need more	16.000	0.000	0.000	20.00	2.00	0.00	22.000	1.000	23.0	161.6	5.80	3,933

Bin count: 64

Facility: Esmond Section: G Total: **551,000**To Even: **551,000****Section: I**

I	004	Square	work floor	0.000	6.500	2.000	46.00	0.00	0.00	46.000	0.000	46.0	10.5	2.00	493
I	005	Square	work floor	0.000	10.50	6.500	44.50	0.00	0.00	44.500	0.000	44.5	54.9	4.50	2,553
I	006	Square	work floor	0.000	11.50	6.000	47.00	0.00	0.00	47.000	0.000	47.0	55.5	4.80	2,734
I	007	Square	work floor	0.000	10.50	6.500	46.00	0.00	0.00	46.000	0.000	46.0	54.9	4.50	2,639
I	008	Square		0.000	12.00	10.50	64.00	0.00	0.00	64.000	0.000	64.0	101.3	6.00	6,872
I	009	Square	work floor	0.000	12.00	10.50	64.00	0.00	0.00	64.000	0.000	64.0	101.3	6.00	6,872
I	010	Square	work floor	0.000	12.00	10.50	65.00	0.00	0.00	65.000	0.000	65.0	101.3	6.00	6,980
I	011	Square	work floor	0.000	12.00	10.50	64.00	0.00	0.00	64.000	0.000	64.0	101.3	6.00	6,872
I	012	Square	work floor	0.000	12.00	11.50	65.00	0.00	0.00	65.000	0.000	65.0	110.9	6.20	7,656
I	013 T	Square	work floor	0.000	5.500	5.500	17.00	0.00	0.00	17.000	0.000	17.0	24.3	2.50	423
I	013 B	Square	work floor - top 17'	0.000	11.50	5.500	30.00	0.00	0.00	30.000	0.000	30.0	50.8	4.50	1,593
I	013A	Square	work floor	0.000	5.500	5.500	17.00	0.00	0.00	17.000	0.000	17.0	24.3	2.50	423
I	014 T	Square	work floor	0.000	4.300	4.000	25.00	0.00	0.00	25.000	0.000	25.0	13.8	2.00	352
I	014 B	Square	work floor - top 25'	0.000	10.50	4.000	20.00	0.00	0.00	20.000	0.000	20.0	33.8	2.50	693
I	016	Square	work floor	0.000	5.000	2.500	45.00	0.00	0.00	45.000	0.000	45.0	10.0	2.00	459
I	017	Square	work floor	0.000	6.500	5.500	47.50	0.00	0.00	47.500	0.000	47.5	28.7	2.50	1,397
I	018	Square	work floor	0.000	6.500	5.500	47.50	0.00	0.00	47.500	0.000	47.5	28.7	2.50	1,397

Exam Date:09/23/2015

Fessenden Cooperative Association

Page: 21

Examiner: 2

PO Box 126
Fessenden , ND
County:

Status	Section	Bin Number	Bin Type	Base Point	Diameter or Bu/Ft (Irreg).		Side wall	Add for Hopper	Ded. for Obst.	Effective Depth	Add for Peak	Depth for Capac.	Bushels per Foot	Base Pack%	Bushel Capacity with Pack	
					Length	Width										
I		019	Square	work floor	0.000	6.500	5.500	47.00	0.00	0.00	47.000	0.000	47.0	28.7	2.50	1,383
I		020	Square	work floor	0.000	6.500	5.500	47.00	0.00	0.00	47.000	0.000	47.0	28.7	2.50	1,383
I		021	Square	work floor	0.000	5.500	3.500	25.00	0.00	0.00	25.000	0.000	25.0	15.5	2.00	396
I		102	Square	work floor	0.000	9.000	7.500	38.00	0.00	0.00	38.000	0.000	38.0	54.3	4.50	2,156
I		103	Square	work floor	0.000	11.00	7.500	29.00	0.00	0.00	29.000	0.000	29.0	66.3	5.00	2,019
I		104	Irregular	work floor 11X7.5 ??	63.200	0.000	0.000	29.00	0.00	0.00	29.000	0.000	29.0	63.2	5.00	1,925
I		105 T	Square	work floor	0.000	7.500	5.000	8.000	0.00	0.00	8.000	0.000	8.0	30.1	2.50	247
I		105 B	Square	work floor - top 8'	0.000	9.000	7.500	31.00	0.00	0.00	31.000	0.000	31.0	54.3	4.50	1,759
I		106	Square	work floor	0.000	9.000	7.500	39.00	0.00	0.00	39.000	0.000	39.0	54.3	4.50	2,213
I		108	Square	work floor	0.000	9.000	7.500	38.50	0.00	0.00	38.500	0.000	38.5	54.3	4.50	2,185
I		109	Square	work floor	0.000	11.00	7.500	25.00	0.00	0.00	25.000	0.000	25.0	66.3	5.00	1,741
I		110	Square	work floor	0.000	7.500	4.000	8.000	0.00	0.00	8.000	0.000	8.0	24.1	2.50	198
I		111	Square	work floor	0.000	9.000	7.500	38.50	0.00	0.00	38.500	0.000	38.5	54.3	4.50	2,185
I		112	Square	work floor	0.000	9.000	7.500	39.00	0.00	0.00	39.000	0.000	39.0	54.3	4.50	2,213
I		201 T	Square	work floor	0.000	11.50	10.00	34.00	0.00	0.00	34.000	0.000	34.0	92.4	5.80	3,324
I		201 B	Square	work floor - top 34'	0.000	10.00	9.500	6.000	0.00	0.00	6.000	0.000	6.0	76.4	5.50	483
I		202 T	Square	work floor	0.000	11.50	10.50	34.00	0.00	0.00	34.000	0.000	34.0	97.1	6.00	3,499
I		202 B	Square	work floor - top 34'	0.000	10.50	9.500	6.000	0.00	0.00	6.000	0.000	6.0	80.2	5.50	507
I		203 T	Square	work floor	0.000	11.50	10.00	34.00	0.00	0.00	34.000	0.000	34.0	92.4	5.80	3,324
I		203 B	Square	work floor - top 34'	0.000	10.00	9.500	6.000	0.00	0.00	6.000	0.000	6.0	76.4	5.50	483
I		204 T	Square	work floor	0.000	11.50	10.00	34.00	0.00	0.00	34.000	0.000	34.0	92.4	5.80	3,324
I		204 B	Square	work floor - top 34'	0.000	10.00	9.500	6.000	0.00	0.00	6.000	0.000	6.0	76.4	5.50	483
I		205 T	Square	work floor	0.000	11.50	10.50	34.00	0.00	0.00	34.000	0.000	34.0	97.1	6.00	3,499

Section: I

NDPSC Bin Capacity Chart

Exam Date:09/23/2015

Fessenden Cooperative Association
 PO Box 126
 Fessenden , ND
 County:

Examiner: 2

Status	Section	Bin Number	Bin Type	Base Point	Diameter or Bu/Ft (Irreg).		Side wall	Add for Hopper	Ded. for Obst.	Effective Depth	Add for Peak	Depth for Capac.	Bushels per Foot	Base Pack%	Bushel Capacity with Pack
					Length	Width									
I	205 B	Square	work floor - top 34'	0.000	10.50	9.500	6.000	0.00	0.00	6.000	0.000	6.0	80.2	5.50	507
I	206 T	Square	work floor	0.000	11.50	10.00	34.00	0.00	0.00	34.000	0.000	34.0	92.4	5.80	3,324
I	206 B	Square	work floor - top 34'	0.000	10.00	9.500	6.000	0.00	0.00	6.000	0.000	6.0	76.4	5.50	483
I	301	Peaked	top of sidewall	35.900	0.000	0.000	23.00	0.00	0.00	23.000	2.200	25.2	813.7	10.0	22,556
I	302	Peaked	top of sidewall	35.900	0.000	0.000	23.00	0.00	0.00	23.000	2.200	25.2	813.7	10.0	22,556
I	303	Peaked	top of sidewall	35.900	0.000	0.000	23.00	0.00	0.00	23.000	2.200	25.2	813.7	10.0	22,556
I	304	Peaked	top of sidewall	13.500	0.000	0.000	12.00	2.00	0.00	14.000	0.800	14.8	115.1	5.20	1,792
I	305	Peaked	top of sidewall	13.500	0.000	0.000	12.00	2.00	0.00	14.000	0.800	14.8	115.1	5.20	1,792

Bin count: 48

Facility: Hamberg Section: I Total: **166,903**

To Even: **167,000**

Section: I-G

I-G	ground	Temporary	50,000 bu. ground	11.000	160.0	60.00	1.000	0.00	0.00	1.000	4.800	5.8	7717.0	10.0	49,235
-----	--------	-----------	-------------------	--------	-------	-------	-------	------	------	-------	-------	-----	--------	------	--------

Bin count: 1

Facility: Hamberg Section: I-G Total: **49,235**

To Even: **50,000**

Section: J

J	001	Peaked	top of sidewall	15.500	0.000	0.000	15.00	2.00	0.00	17.000	0.900	17.9	151.7	5.50	2,864
J	002	Peaked	top of sidewall	16.000	0.000	0.000	25.00	2.00	0.00	27.000	1.000	28.0	161.6	5.80	4,787
J	003	Peaked	top of sidewall	15.500	0.000	0.000	30.00	2.00	0.00	32.000	0.900	32.9	151.7	5.50	5,266
J	004	Peaked	top of sidewall	15.500	0.000	0.000	30.00	2.00	0.00	32.000	0.900	32.9	151.7	5.50	5,266
J	005	Peaked	top of sidewall	15.500	0.000	0.000	15.00	2.00	0.00	17.000	0.900	17.9	151.7	5.50	2,864

Exam Date:09/23/2015

Fessenden Cooperative Association

Page: 23

Examiner: 2

PO Box 126
Fessenden , ND
County:

Status	Section	Bin Number	Bin Type	Base Point	Diameter or Bu/Ft (Irreg).		Side wall	Add for Hopper	Ded. for Obst.	Effective Depth	Add for Peak	Depth for Capac.	Bushels per Foot	Base Pack%	Bushel Capacity with Pack	
					Length	Width										
J	006	Peaked	top of sidewall		15.500	0.000	0.000	30.00	3.70	0.00	33.700	0.900	34.6	151.7	5.50	5,538
J	007	Peaked	top of sidewall		16.000	0.000	0.000	25.00	2.00	0.00	27.000	1.000	28.0	161.6	5.80	4,787
J	008	Peaked	top of sidewall		16.000	0.000	0.000	25.00	2.00	0.00	27.000	1.000	28.0	161.6	5.80	4,787
J	009	Peaked	top of sidewall		15.500	0.000	0.000	15.00	2.00	0.00	17.000	0.900	17.9	151.7	5.50	2,864
J	010	Peaked	top of sidewall		15.500	0.000	0.000	15.00	2.00	0.00	17.000	0.900	17.9	151.7	5.50	2,864
J	011	Peaked	top of sidewall		15.500	0.000	0.000	30.00	2.50	0.00	32.500	0.900	33.4	151.7	5.50	5,346
J	012	Peaked	top of sidewall		15.500	0.000	0.000	30.00	2.50	0.00	32.500	0.900	33.4	151.7	5.50	5,346
J	013	Peaked	top of sidewall		15.500	0.000	0.000	30.00	2.50	0.00	32.500	0.900	33.4	151.7	5.50	5,346
J	014	Flat	grain wall ht. 11.0'		0.000	123.5	48.50	11.00	0.00	0.00	11.000	0.000	11.0	4814.9	10.0	58,260
J	015	Peaked	top of sidewall		48.000	0.000	0.000	33.00	0.00	0.00	33.000	3.400	36.4	1454.6	10.0	58,242
J	016	Peaked	top of sidewall		15.500	0.000	0.000	15.00	2.00	0.00	17.000	0.900	17.9	151.7	5.50	2,864
J	017	Peaked	top of sidewall		15.500	0.000	0.000	15.00	2.00	0.00	17.000	0.900	17.9	151.7	5.50	2,864
J	101	Square	top of bin		0.000	10.00	10.00	14.20	2.10	0.00	16.300	0.000	16.3	80.4	5.50	1,383
J	102	Square	work floor		0.000	10.00	10.00	14.30	2.10	0.00	16.400	0.000	16.4	80.4	5.50	1,392
J	103	Square	work floor		0.000	10.00	10.00	14.50	2.10	0.00	16.600	0.000	16.6	80.4	5.50	1,408
J	104	Square	work floor		0.000	10.00	10.00	14.70	2.10	0.00	16.800	0.000	16.8	80.4	5.50	1,425
J	105	Square	work floor		0.000	10.00	10.00	14.80	2.10	0.00	16.900	0.000	16.9	80.4	5.50	1,434
J	106	Square	work floor		0.000	10.00	10.00	15.00	2.10	0.00	17.100	0.000	17.1	80.4	5.50	1,451
J	107	Square	work floor		0.000	10.00	10.00	15.20	2.10	0.00	17.300	0.000	17.3	80.4	5.50	1,468
J	108	Square	work floor		0.000	10.00	10.00	15.30	2.10	0.00	17.400	0.000	17.4	80.4	5.50	1,476
J	109	Square	work floor		0.000	10.00	10.00	15.50	2.10	0.00	17.600	0.000	17.6	80.4	5.50	1,493
J	110	Square	work floor		0.000	10.00	10.00	15.70	2.10	0.00	17.800	0.000	17.8	80.4	5.50	1,510
J	111	Square	work floor		0.000	10.00	10.00	15.80	2.10	0.00	17.900	0.000	17.9	80.4	5.50	1,518

Section: J

NDPSC Bin Capacity Chart

Exam Date:09/23/2015

Fessenden Cooperative Association
PO Box 126
Fessenden , ND
County:

Examiner: 2

Status	Section	Bin Number	Bin Type	Base Point	Diameter or Bu/Ft (Irreg).		Side wall	Add for Hopper	Ded. for Obst.	Effective Depth	Add for Peak	Depth for Capac.	Bushels per Foot	Base Pack%	Bushel Capacity with Pack
					Length	Width									

Section: J

J	112	Square	work floor		0.000	10.00	10.00	16.00	2.10	0.00	18.100	0.000	18.1	80.4	5.50	1,535
J	201	Square	work floor		0.000	10.00	5.000	10.70	1.50	0.00	12.200	0.000	12.2	40.2	3.00	505
J	202	Square	work floor		0.000	10.00	5.000	10.80	1.50	0.00	12.300	0.000	12.3	40.2	3.00	509
J	203	Square	work floor		0.000	10.00	5.000	11.00	1.50	0.00	12.500	0.000	12.5	40.2	3.00	518
J	204	Square	work floor		0.000	10.00	5.000	11.20	1.50	0.00	12.700	0.000	12.7	40.2	3.00	526
J	205	Square	work floor		0.000	10.00	5.000	11.30	1.50	0.00	12.800	0.000	12.8	40.2	3.00	530
J	206	Square	work floor		0.000	10.00	5.000	11.50	1.50	0.00	13.000	0.000	13.0	40.2	3.00	539
J	207	Square	work floor		0.000	10.00	5.000	11.70	1.50	0.00	13.200	0.000	13.2	40.2	3.00	547
J	208	Square	work floor		0.000	10.00	5.000	11.80	1.50	0.00	13.300	0.000	13.3	40.2	3.00	551
J	209	Square	work floor		0.000	10.00	5.000	12.00	1.50	0.00	13.500	0.000	13.5	40.2	3.00	559
J	210	Square	work floor		0.000	10.00	5.000	12.10	1.50	0.00	13.600	0.000	13.6	40.2	3.00	563
J	211	Square	work floor		0.000	10.00	5.000	12.30	1.50	0.00	13.800	0.000	13.8	40.2	3.00	572
J	212	Square	work floor		0.000	10.00	5.000	12.50	1.50	0.00	14.000	0.000	14.0	40.2	3.00	580

Bin count: 41

Facility: Carrington Section: J Total: 204,147

To Even: 205,000

Section: J-M

J-M	001 T	Square	floor over bins		0.000	11.00	6.000	57.00	0.00	0.00	57.000	0.000	57.0	53.1	4.50	3,163
J-M	001 B	Square	57' to bottom		0.000	10.90	12.40	15.00	0.00	0.00	15.000	0.000	15.0	108.6	6.20	1,730
J-M	002 T	Square	floor over bins		0.000	12.10	6.000	57.00	0.00	0.00	57.000	0.000	57.0	58.4	4.80	3,489
J-M	002 B	Square	57' to bottom		0.000	11.90	12.40	15.00	0.00	0.00	15.000	0.000	15.0	118.6	6.20	1,889
J-M	004	Square	floor over bins		0.000	12.10	6.600	56.00	0.00	0.00	56.000	0.000	56.0	64.2	5.00	3,775
J-M	005 T	Square	floor over bins		0.000	11.10	6.000	57.00	0.00	0.00	57.000	0.000	57.0	53.5	4.50	3,187

Exam Date:09/23/2015

Fessenden Cooperative Association

Page: 25

Examiner: 2

PO Box 126
Fessenden , ND
County:

Status	Section	Bin Number	Bin Type	Base Point	Diameter or Bu/Ft (Irreg).		Side wall	Add for Hopper	Ded. for Obst.	Effective Depth	Add for Peak	Depth for Capac.	Bushels per Foot	Base Pack%	Bushel Capacity with Pack	
					Length	Width										
	J-M	005 B	Square	57' to bottom	0.000	10.90	12.40	15.00	0.00	0.00	15.000	0.000	15.0	108.6	6.20	1,730
	J-M	006	Square	floor over bins	0.000	11.00	6.600	56.00	0.00	0.00	56.000	0.000	56.0	58.4	4.80	3,427
	J-M	007	Square	floor over bins	0.000	11.00	6.800	56.00	0.00	0.00	56.000	0.000	56.0	60.1	4.80	3,528
	J-M	008	Square	floor over bins	0.000	11.00	6.300	56.00	0.00	0.00	56.000	0.000	56.0	55.7	4.80	3,269
	J-M	009	Square	floor over bins	0.000	11.00	6.600	56.00	0.00	0.00	56.000	0.000	56.0	58.4	4.80	3,427
	J-M	010 T	Square	floor over bins	0.000	11.10	6.000	57.00	0.00	0.00	57.000	0.000	57.0	53.5	4.50	3,187
	J-M	010 B	Square	57' to bottom	0.000	10.90	12.30	15.00	0.00	0.00	15.000	0.000	15.0	107.8	6.20	1,717
	J-M	012	Square	floor over bins	0.000	12.10	6.100	56.00	0.00	0.00	56.000	0.000	56.0	59.3	4.80	3,480
	J-M	013	Square	floor over bins	0.000	12.10	6.600	56.00	0.00	0.00	56.000	0.000	56.0	64.2	5.00	3,775
	J-M	014 T	Square	floor over bins	0.000	11.10	6.000	57.00	0.00	0.00	57.000	0.000	57.0	53.5	4.50	3,187
	J-M	014 B	Square	57' to bottom	0.000	10.90	12.30	15.00	0.00	0.00	15.000	0.000	15.0	107.8	6.20	1,717
	J-M	016	Square	floor over bins	0.000	11.00	3.000	54.00	0.00	0.00	54.000	0.000	54.0	26.5	2.50	1,467
	J-M	017	Square	floor over bins	0.000	12.10	6.300	52.00	0.00	0.00	52.000	0.000	52.0	61.3	4.80	3,341
	J-M	018	Square	floor over bins	0.000	11.00	6.600	56.00	0.00	0.00	56.000	0.000	56.0	58.4	4.80	3,427
	J-M	019	Square	floor over bins	0.000	12.10	6.800	52.00	0.00	0.00	52.000	0.000	52.0	66.1	5.00	3,609
	J-M	020	Square	floor over bins	0.000	11.00	3.600	54.00	0.00	0.00	54.000	0.000	54.0	31.8	2.50	1,760
	J-M	021	Square	floor over bins	0.000	3.300	6.000	54.00	0.00	0.00	54.000	0.000	54.0	15.9	2.00	876
	J-M	022 T	Square	floor over bins	0.000	5.500	6.600	40.00	0.00	0.00	40.000	0.000	40.0	29.2	2.50	1,197
	J-M	022 B	Square	40' to bottom	0.000	11.00	6.600	16.00	0.00	0.00	16.000	0.000	16.0	58.4	4.80	979
	J-M	022CL	Square	floor over bins	0.000	4.300	6.600	40.00	0.00	0.00	40.000	0.000	40.0	22.8	2.00	930
	J-M	101 T	Square	floor over bins	0.000	11.30	12.50	42.00	0.00	0.00	42.000	0.000	42.0	113.5	6.20	5,063
	J-M	101 M	Square	42' to middle	0.000	12.20	12.40	16.00	0.00	0.00	16.000	0.000	16.0	121.6	6.50	2,072
	J-M	101B	Square	58' to bottom	0.000	12.90	12.30	14.00	0.00	0.00	14.000	0.000	14.0	127.5	6.50	1,901

Section: J-M

Exam Date:09/23/2015

Fessenden Cooperative Association

Page: 26

Examiner: 2

PO Box 126
Fessenden , ND
County:

Status	Section	Bin Number	Bin Type	Base Point	Diameter or Bu/Ft (Irreg).		Side wall	Add for Hopper	Ded. for Obst.	Effective Depth	Add for Peak	Depth for Capac.	Bushels per Foot	Base Pack%	Bushel Capacity with Pack	
					Length	Width										
	J-M	102 T	Square	floor over bins	0.000	12.00	12.50	42.00	0.00	0.00	42.000	0.000	42.0	120.6	6.50	5,394
	J-M	102 M	Square	42' to middle	0.000	10.00	12.40	16.00	0.00	0.00	16.000	0.000	16.0	99.7	6.00	1,691
	J-M	102B	Square	58' to bottom	0.000	8.000	12.30	7.000	0.00	0.00	7.000	0.000	7.0	79.1	5.50	584
	J-M	103 T	Square	floor over bins	0.000	11.30	12.50	42.00	0.00	0.00	42.000	0.000	42.0	113.5	6.20	5,063
	J-M	103 M	Square	42' to middle	0.000	12.20	12.40	16.00	0.00	0.00	16.000	0.000	16.0	121.6	6.50	2,072
	J-M	103B	Square	58' to bottom	0.000	12.90	12.30	14.00	0.00	0.00	14.000	0.000	14.0	127.5	6.50	1,901
	J-M	104 T	Square	floor over bins	0.000	11.30	11.30	42.00	0.00	0.00	42.000	0.000	42.0	102.6	6.00	4,568
	J-M	104 M	Square	42' to bottom	0.000	12.20	11.20	16.00	0.00	0.00	16.000	0.000	16.0	109.8	6.20	1,866
	J-M	104B	Square	58' to bottom	0.000	12.90	11.10	14.00	0.00	0.00	14.000	0.000	14.0	115.1	6.20	1,711
	J-M	105 T	Square	floor over bins	0.000	12.00	11.30	42.00	0.00	0.00	42.000	0.000	42.0	109.0	6.20	4,862
	J-M	105 M	Square	42' to middle	0.000	10.00	11.20	16.00	0.00	0.00	16.000	0.000	16.0	90.0	5.80	1,524
	J-M	105B	Square	58' to bottom	0.000	8.000	11.10	7.000	0.00	0.00	7.000	0.000	7.0	71.4	5.20	526
	J-M	106 T	Square	floor over bins	0.000	11.30	11.30	42.00	0.00	0.00	42.000	0.000	42.0	102.6	6.00	4,568
	J-M	106 M	Square	42' to bottom	0.000	12.20	11.20	16.00	0.00	0.00	16.000	0.000	16.0	109.8	6.20	1,866
	J-M	106B	Square	58' to bottom	0.000	12.90	11.10	14.00	0.00	0.00	14.000	0.000	14.0	115.1	6.20	1,711
	J-M	107 T	Square	floor over bins	0.000	11.30	11.30	42.00	0.00	0.00	42.000	0.000	42.0	102.6	6.00	4,568
	J-M	107 M	Square	42' to middle	0.000	12.20	11.20	16.00	0.00	0.00	16.000	0.000	16.0	109.8	6.20	1,866
	J-M	107B	Square	58' to bottom	0.000	12.90	11.10	14.00	0.00	0.00	14.000	0.000	14.0	115.1	6.20	1,711
	J-M	108 T	Square	floor over bins	0.000	12.00	11.30	42.00	0.00	0.00	42.000	0.000	42.0	109.0	6.20	4,862
	J-M	108 M	Square	42' to middle	0.000	10.00	11.20	16.00	0.00	0.00	16.000	0.000	16.0	90.0	5.80	1,524
	J-M	108B	Square	58' to bottom	0.000	8.000	11.10	7.000	0.00	0.00	7.000	0.000	7.0	71.4	5.20	526
	J-M	109 T	Square	floor over bins	0.000	11.30	11.30	42.00	0.00	0.00	42.000	0.000	42.0	102.6	6.00	4,568
	J-M	109 M	Square	42' to middle	0.000	12.20	11.20	16.00	0.00	0.00	16.000	0.000	16.0	109.8	6.20	1,866

Section: J-M

NDPSC Bin Capacity Chart

Exam Date:09/23/2015

Examiner: 2

Fessenden Cooperative Association
 PO Box 126
 Fessenden, ND
 County:

Status	Section	Bin Number	Bin Type	Base Point	Diameter or Bu/Ft (Irreg.)		Side wall	Add for Hopper	Ded. for Obst.	Effective Depth	Add for Peak	Depth for Capac.	Bushels per Foot	Base Pack%	Bushel Capacity with Pack	
					Length	Width										
	J-M	109B	Square	58' to bottom	0.000	12.90	11.10	14.00	0.00	0.00	14.000	0.000	14.0	115.1	6.20	1,711
	J-M	201	Peaked	top of sidewall	36.000	0.000	0.000	73.30	0.00	0.00	73.300	2.200	75.5	818.2	10.0	67,951
	J-M	202	Peaked	top of sidewall	35.900	0.000	0.000	72.00	0.00	0.00	72.000	2.200	74.2	813.7	10.0	66,415

Bin count: 55

Facility: Maddock Section: J-M Total: **273,774**

To Even: **274,000**

Section: K

K	401	Irregular	slab floor 9.9x9.7 less fillets	76.600	0.000	0.000	110.0	0.00	0.00	110.00	0.000	110.0	76.6	5.50	8,889
K	402	Irregular	slab floor 9.9x9.7 less fillets	76.600	0.000	0.000	110.0	0.00	0.00	110.00	0.000	110.0	76.6	5.50	8,889
K	403	Irregular	slab floor 10.9x9.1 less	79.100	0.000	0.000	109.5	0.00	0.00	109.50	0.000	109.5	79.1	5.50	9,137
K	404	Irregular	slab floor 9.1x10.9 less	79.100	0.000	0.000	109.5	0.00	0.00	109.50	0.000	109.5	79.1	5.50	9,137
K	405	Irregular	slab floor	46.900	0.000	0.000	138.0	0.00	0.00	138.00	0.000	138.0	46.9	4.00	6,731
K	406	Irregular	slab floor	46.900	0.000	0.000	138.0	0.00	0.00	138.00	0.000	138.0	46.9	4.00	6,731
K	407	Irregular	slab floor 10.9x9.1 less	79.100	0.000	0.000	109.5	0.00	0.00	109.50	0.000	109.5	79.1	5.50	9,137
K	408	Irregular	slab floor 9.1x10.9 less	79.100	0.000	0.000	109.5	0.00	0.00	109.50	0.000	109.5	79.1	5.50	9,137
K	409	Irregular	slab floor 9.9x9.7	76.600	0.000	0.000	110.0	0.00	0.00	110.00	0.000	110.0	76.6	5.50	8,889
K	410	Round	slab floor	30.000	0.000	0.000	128.5	0.00	0.00	128.50	0.000	128.5	568.2	9.00	79,585
K	411	Irregular	slab floor 9.9x9.7 less fillets	76.600	0.000	0.000	110.0	0.00	0.00	110.00	0.000	110.0	76.6	5.50	8,889
K	412	Irregular	slab floor	30.500	0.000	0.000	113.0	0.00	0.00	113.00	0.000	113.0	30.5	2.50	3,533
K	413	Irregular	slab floor	143.90	0.000	0.000	136.0	0.00	0.00	136.00	0.000	136.0	143.9	6.80	20,901
K	420	Round	slab floor	30.000	0.000	0.000	128.5	0.00	0.00	128.50	0.000	128.5	568.2	9.00	79,585
K	430	Round	slab floor	30.000	0.000	0.000	132.0	0.00	0.00	132.00	0.000	132.0	568.2	9.00	81,752
K	440	Round	slab floor	30.000	0.000	0.000	128.5	0.00	0.00	128.50	0.000	128.5	568.2	9.00	79,585

Exam Date:09/23/2015

Fessenden Cooperative Association
PO Box 126
Fessenden , ND
County:

Page: 28

Examiner: 2

Status	Section	Bin Number	Bin Type	Base Point	Diameter or Bu/Ft (Irreg).		Side wall	Add for Hopper	Ded. for Obst.	Effective Depth	Add for Peak	Depth for Capac.	Bushels per Foot	Base Pack%	Bushel Capacity with Pack	
					Length	Width										
	Section: K															
	K	450	Round	slab floor	30.000	0.000	0.000	128.5	0.00	0.00	128.50	0.000	128.5	568.2	9.00	79,585
	K	460	Round	slab floor	30.000	0.000	0.000	132.0	0.00	0.00	132.00	0.000	132.0	568.2	9.00	81,752
	K	470	Round	slab floor	62.000	0.000	0.000	138.0	0.00	0.00	138.00	0.000	138.0	2426.9	10.0	368,403
	K	480	Round	slab floor	62.000	0.000	0.000	138.0	0.00	0.00	138.00	0.000	138.0	2426.9	10.0	368,403
	K	490	Peaked	top of sidewall	104.40	0.000	0.000	90.75	0.00	0.00	90.750	7.300	98.1	6881.3	10.0	742,562
	K	500	Peaked	top of sidewall	104.40	0.000	0.000	104.0	0.00	0.00	104.00	7.300	111.3	6881.3	10.0	842,478

Bin count: 22

Facility: Carrington Section: K Total: 2,913,690

To Even: 2,914,000

Section: K-G

	K-G	ground	Temporary	500,000 bu. ground	28.000	318.0	149.0	0.200	0.00	0.00	0.200	11.70	11.9	38088.4	10.0	498,577
--	-----	--------	-----------	--------------------	--------	-------	-------	-------	------	------	-------	-------	------	---------	------	---------

Bin count: 1

Facility: Carrington Section: K-G Total: 498,577

To Even: 499,000

Section: K-M

	K-M	001	Peaked	top of sidewall	13.700	0.000	0.000	12.00	0.00	0.00	12.000	0.800	12.8	118.5	5.20	1,596
	K-M	002	Peaked	top of sidewall	13.700	0.000	0.000	12.00	0.00	0.00	12.000	0.800	12.8	118.5	5.20	1,596
	K-M	003	Peaked	top of sidewall	13.700	0.000	0.000	12.00	0.00	0.00	12.000	0.800	12.8	118.5	5.20	1,596
	K-M	004	Peaked	top of sidewall	13.700	0.000	0.000	12.00	0.00	0.00	12.000	0.800	12.8	118.5	5.20	1,596
	K-M	005	Peaked	top of sidewall	13.700	0.000	0.000	12.00	0.00	0.00	12.000	0.800	12.8	118.5	5.20	1,596
	K-M	010	Peaked	top of sidewall	16.000	0.000	0.000	20.00	2.00	0.00	22.000	1.000	23.0	161.6	5.80	3,933
	K-M	011	Peaked	top of sidewall	16.000	0.000	0.000	20.00	2.00	0.00	22.000	1.000	23.0	161.6	5.80	3,933

Exam Date:09/23/2015

Fessenden Cooperative Association

Page: 29

Examiner: 2

PO Box 126
Fessenden , ND
County:

Status	Section	Bin Number	Bin Type	Base Point	Diameter or Bu/Ft (Irreg).		Side wall	Add for Hopper	Ded. for Obst.	Effective Depth	Add for Peak	Depth for Capac.	Bushels per Foot	Base Pack%	Bushel Capacity with Pack	
					Length	Width										
	K-M	012	Peaked	top of sidewall	15.500	0.000	0.000	25.00	2.00	0.00	27.000	0.900	27.9	151.7	5.50	4,465
	K-M	013	Peaked	top of sidewall	15.500	0.000	0.000	25.00	2.00	0.00	27.000	0.900	27.9	151.7	5.50	4,465
	K-M	014	Peaked	top of sidewall	15.500	0.000	0.000	25.00	2.00	0.00	27.000	0.900	27.9	151.7	5.50	4,465
	K-M	015	Peaked	top of sidewall	15.500	0.000	0.000	25.00	2.00	0.00	27.000	0.900	27.9	151.7	5.50	4,465
	K-M	016	Peaked	top of sidewall	15.500	0.000	0.000	25.00	2.00	0.00	27.000	0.900	27.9	151.7	5.50	4,465
	K-M	017	Peaked	top of sidewall	15.500	0.000	0.000	25.00	2.00	0.00	27.000	0.900	27.9	151.7	5.50	4,465
	K-M	018	Peaked	top of sidewall	15.500	0.000	0.000	25.00	2.00	0.00	27.000	0.900	27.9	151.7	5.50	4,465
	K-M	022	Peaked	top of sidewall	47.700	0.000	0.000	31.80	0.00	0.00	31.800	2.900	34.7	1436.5	10.0	54,832
	K-M	023	Peaked	top of sidewall	47.700	0.000	0.000	46.50	0.00	0.00	46.500	2.900	49.4	1436.5	10.0	78,059
	K-M	024	Peaked	top of sidewall	47.700	0.000	0.000	46.50	0.00	0.00	46.500	2.900	49.4	1436.5	10.0	78,059
	K-M	025	Peaked	top of sidewall	48.400	0.000	0.000	46.70	0.00	0.00	46.700	3.400	50.1	1479.0	10.0	81,508

Bin count: 18

Facility: Maddock Section: K-M Total: 339,559

To Even: 340,000

Section: L

L	001 T	Irregular	work floor - 12.3 x 6.8	53.000	0.000	0.000	10.00	0.00	0.00	10.000	0.000	10.0	53.0	4.50	554
L	001 B	Square	work floor - top 10'	0.000	12.30	6.800	39.00	0.00	0.00	39.000	0.000	39.0	67.2	5.20	2,757
L	002 T	Square	work floor	0.000	5.000	4.000	32.00	0.00	0.00	32.000	0.000	32.0	16.1	2.00	525
L	002 B	Square	work floor - top 32'	0.000	11.00	4.000	19.00	0.00	0.00	19.000	0.000	19.0	35.4	3.00	693
L	003	Square	work floor	0.000	5.700	4.000	32.00	0.00	0.00	32.000	0.000	32.0	18.3	2.00	598
L	004	Square	work floor	0.000	11.00	6.700	51.00	0.00	0.00	51.000	0.000	51.0	59.2	4.80	3,164
L	005 T	Square	work floor	0.000	11.00	6.200	53.00	0.00	0.00	53.000	0.000	53.0	54.8	4.50	3,035
L	005 B	Square	work floor - top 53'	0.000	12.50	11.00	15.00	0.00	0.00	15.000	0.000	15.0	110.5	6.20	1,761

Exam Date:09/23/2015

Fessenden Cooperative Association

Page: 30

Examiner: 2

PO Box 126
Fessenden , ND
County:

Status	Section	Bin Number	Bin Type	Base Point	Diameter or Bu/Ft (Irreg).		Side wall	Add for Hopper	Ded. for Obst.	Effective Depth	Add for Peak	Depth for Capac.	Bushels per Foot	Base Pack%	Bushel Capacity with Pack	
					Length	Width										
	L	006	Square	work floor	0.000	6.000	4.500	14.00	0.00	0.00	14.000	0.000	14.0	21.7	2.00	310
	L	008	Square	work floor	0.000	12.30	6.200	51.00	0.00	0.00	51.000	0.000	51.0	61.3	4.80	3,276
	L	009 T	Square	work floor	0.000	7.800	6.700	14.00	0.00	0.00	14.000	0.000	14.0	42.0	3.50	609
	L	009 B	Square	work floor - top 14'	0.000	12.30	6.700	36.00	0.00	0.00	36.000	0.000	36.0	66.2	5.00	2,502
	L	010 T	Square	work floor	0.000	11.00	6.200	53.00	0.00	0.00	53.000	0.000	53.0	54.8	4.50	3,035
	L	010 B	Square	work floor - top 53'	0.000	12.50	11.00	15.00	0.00	0.00	15.000	0.000	15.0	110.5	6.20	1,761
	L	011	Square	work floor	0.000	11.00	6.700	51.00	0.00	0.00	51.000	0.000	51.0	59.2	4.80	3,164
	L	013 T	Irregular	work floor 11 x 6.8 obstruct	46.000	0.000	0.000	10.00	0.00	0.00	10.000	0.000	10.0	46.0	4.00	478
	L	013 B	Square	work floor _ top 10'	0.000	11.00	6.800	40.50	0.00	0.00	40.500	0.000	40.5	60.1	4.80	2,551
	L	015 T	Irregular	work floor 11 x 6.8 obstruct	46.000	0.000	0.000	10.00	0.00	0.00	10.000	0.000	10.0	46.0	4.00	478
	L	015 B	Square	work floor - top 10'	0.000	11.00	6.800	39.00	0.00	0.00	39.000	0.000	39.0	60.1	4.80	2,457
	L	016	Square	work floor	0.000	11.00	6.700	51.00	0.00	0.00	51.000	0.000	51.0	59.2	4.80	3,164
	L	017 T	Square	work floor	0.000	11.00	6.200	53.00	0.00	0.00	53.000	0.000	53.0	54.8	4.50	3,035
	L	017 B	Square	work floor - top 53'	0.000	12.40	11.00	15.00	0.00	0.00	15.000	0.000	15.0	109.6	6.20	1,746
	L	018	Square	work floor	0.000	12.30	6.700	50.00	0.00	0.00	50.000	0.000	50.0	66.2	5.00	3,476
	L	020 T	Square	work floor	0.000	12.30	6.200	53.00	0.00	0.00	53.000	0.000	53.0	61.3	4.80	3,405
	L	020 B	Square	work floor - top 53'	0.000	12.30	12.40	15.00	0.00	0.00	15.000	0.000	15.0	122.6	6.50	1,959
	L	021 T	Square	work floor	0.000	11.00	6.200	53.00	0.00	0.00	53.000	0.000	53.0	54.8	4.50	3,035
	L	021 B	Square	work floor - top 53'	0.000	11.00	12.40	15.00	0.00	0.00	15.000	0.000	15.0	109.6	6.20	1,746
	L	022	Square	work floor	0.000	11.00	4.000	46.00	0.00	0.00	46.000	0.000	46.0	35.4	3.00	1,677
	L	023	Square	work floor	0.000	11.00	6.700	51.00	0.00	0.00	51.000	0.000	51.0	59.2	4.80	3,164
	L	024	Square	work floor	0.000	4.900	3.700	49.00	0.00	0.00	49.000	0.000	49.0	14.6	2.00	729
	L	025 T	Irregular	work floor 12.3 x 6.8 with	53.000	0.000	0.000	10.00	0.00	0.00	10.000	0.000	10.0	53.0	4.50	554

Section: L

Exam Date:09/23/2015

Fessenden Cooperative Association

Page: 31

Examiner: 2

PO Box 126
Fessenden , ND
County:

Status	Section	Bin Number	Bin Type	Base Point	Diameter or Bu/Ft (Irreg).		Side wall	Add for Hopper	Ded. for Obst.	Effective Depth	Add for Peak	Depth for Capac.	Bushels per Foot	Base Pack%	Bushel Capacity with Pack	
					Length	Width										
L	025 B		Square	work floor - top 10'	0.000	12.30	6.800	37.00	0.00	0.00	37.000	0.000	37.0	67.2	5.20	2,615
L	101		Square	work floor	0.000	10.50	10.50	67.00	0.00	0.00	67.000	0.000	67.0	88.6	5.80	6,280
L	102		Square	work floor	0.000	10.50	9.600	56.00	0.00	0.00	56.000	0.000	56.0	81.0	5.50	4,785
L	103		Square	work floor	0.000	10.50	10.50	67.00	0.00	0.00	67.000	0.000	67.0	88.6	5.80	6,280
L	104		Square	work floor	0.000	10.60	9.600	56.00	0.00	0.00	56.000	0.000	56.0	81.8	5.50	4,833
L	105		Square	work floor	0.000	10.50	10.60	67.00	0.00	0.00	67.000	0.000	67.0	89.5	5.80	6,345
L	106		Square	work floor	0.000	10.50	10.70	67.00	0.00	0.00	67.000	0.000	67.0	90.3	5.80	6,401
L	107		Square	work floor	0.000	10.70	9.600	58.00	0.00	0.00	58.000	0.000	58.0	82.6	5.50	5,055
L	108		Square	work floor	0.000	10.70	10.50	67.00	0.00	0.00	67.000	0.000	67.0	90.3	5.80	6,401
L	109		Square	work floor	0.000	10.60	10.50	67.00	0.00	0.00	67.000	0.000	67.0	89.5	5.80	6,345
L	110		Square	work floor	0.000	10.60	10.50	67.00	0.00	0.00	67.000	0.000	67.0	89.5	5.80	6,345
L	111		Square	work floor	0.000	10.70	10.50	67.00	0.00	0.00	67.000	0.000	67.0	90.3	5.80	6,401
L	112		Square	work floor	0.000	10.60	9.600	58.50	0.00	0.00	58.500	0.000	58.5	81.8	5.50	5,048
L	113		Square	work floor	0.000	10.70	9.600	58.00	0.00	0.00	58.000	0.000	58.0	82.6	5.50	5,055
L	114		Square	work floor	0.000	10.70	10.50	67.00	0.00	0.00	67.000	0.000	67.0	90.3	5.80	6,401
L	115		Square	work floor	0.000	10.60	10.50	67.00	0.00	0.00	67.000	0.000	67.0	89.5	5.80	6,345
L	116		Square	work floor	0.000	10.50	10.50	67.00	0.00	0.00	67.000	0.000	67.0	88.6	5.80	6,280
L	117		Square	work floor	0.000	10.50	9.600	58.50	0.00	0.00	58.500	0.000	58.5	81.0	5.50	5,000
L	119		Square	work floor	0.000	10.50	10.50	67.00	0.00	0.00	67.000	0.000	67.0	88.6	5.80	6,280
L	201		Peaked	top of sidewall	35.900	0.000	0.000	66.00	0.00	0.00	66.000	2.200	68.2	813.7	10.0	61,043
L	202		Peaked	top of sidewall	32.900	0.000	0.000	66.00	0.00	0.00	66.000	2.000	68.0	683.4	9.50	50,886
L	203		Peaked	top of sidewall	26.900	0.000	0.000	66.00	0.00	0.00	66.000	1.600	67.6	456.9	8.50	33,511
L	302		Square	work floor	0.000	11.00	9.500	45.50	0.00	0.00	45.500	0.000	45.5	84.0	5.80	4,044

Section: L

NDPSC Bin Capacity Chart

Exam Date:09/23/2015

Fessenden Cooperative Association
PO Box 126
Fessenden , ND
County:

Page: 32

Examiner: 2

Status	Section	Bin Number	Bin Type	Base Point	Diameter or Bu/Ft (Irreg).		Side wall	Add for Hopper	Ded. for Obst.	Effective Depth	Add for Peak	Depth for Capac.	Bushels per Foot	Base Pack%	Bushel Capacity with Pack	
					Length	Width										
	L	304	Square	work floor	0.000	11.00	9.500	45.50	0.00	0.00	45.500	0.000	45.5	84.0	5.80	4,044
	L	305	Square	work floor	0.000	9.500	5.500	31.00	0.00	0.00	31.000	0.000	31.0	42.0	3.50	1,348
	L	307	Square	work floor	0.000	11.00	9.500	45.50	0.00	0.00	45.500	0.000	45.5	84.0	5.80	4,044
	L	309 T	Square	work floor	0.000	6.000	5.500	8.000	0.00	0.00	8.000	0.000	8.0	26.5	2.50	217
	L	309 B	Square	work floor - top 8'	0.000	9.500	5.500	19.00	0.00	0.00	19.000	0.000	19.0	42.0	3.50	826
	L	310	Square	work floor	0.000	11.00	9.500	45.50	0.00	0.00	45.500	0.000	45.5	84.0	5.80	4,044
	L	311	Square	work floor	0.000	9.500	5.500	27.00	0.00	0.00	27.000	0.000	27.0	42.0	3.50	1,174
	L	312	Square	work floor	0.000	11.00	9.500	45.50	0.00	0.00	45.500	0.000	45.5	84.0	5.80	4,044
	L	313	Square	work floor	0.000	9.500	5.500	31.50	0.00	0.00	31.500	0.000	31.5	42.0	3.50	1,369
	L	315	Square	work floor	0.000	9.500	5.500	31.00	0.00	0.00	31.000	0.000	31.0	42.0	3.50	1,348
	L	316	Square	work floor	0.000	11.00	9.500	45.50	0.00	0.00	45.500	0.000	45.5	84.0	5.80	4,044
	L	401	Peaked	top of sidewall	42.000	0.000	0.000	21.30	0.00	0.00	21.300	2.500	23.8	1113.7	10.0	29,157
	L	402	Peaked	top of sidewall	42.000	0.000	0.000	21.30	0.00	0.00	21.300	2.500	23.8	1113.7	10.0	29,157
	L	403	Peaked	top of sidewall	42.000	0.000	0.000	21.30	0.00	0.00	21.300	2.500	23.8	1113.7	10.0	29,157
	L	404	Peaked	top of sidewall	42.000	0.000	0.000	21.30	0.00	0.00	21.300	2.500	23.8	1113.7	10.0	29,157
	L	405	Peaked	top of sidewall	42.000	0.000	0.000	21.30	0.00	0.00	21.300	2.500	23.8	1113.7	10.0	29,157
	L	500	Quonset	btm center horizontal	0.000	303.0	60.00	12.00	0.00	0.00	12.000	0.000	12.0	14214.4	10.0	187,631

Bin count: 71

Facility: New Rockford Section: L Total: 679,295

To Even: 680,000

Overall Licensed Bin Capacity for:

Fessenden Cooperative Association

Bin count: 657

Licensed Capacity:
(includes pack)

11,447,446 Bu.

Licensed Capacity (to even):
(includes pack and section totals are
rounded up to next highest 1000)

11,456,000 Bu.

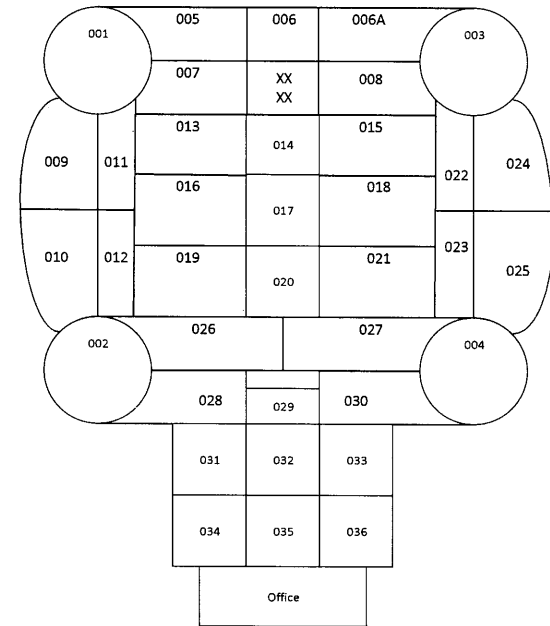
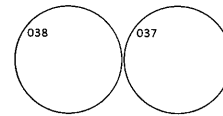
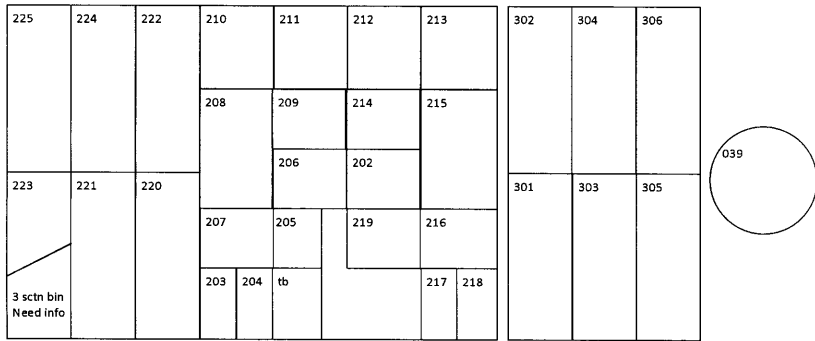

Fessenden Co-op Association

Section A

Fessenden Co-op Association

Section A

**Fessenden Co-op Association
Fessenden ND
New 8 Pack
Section A**

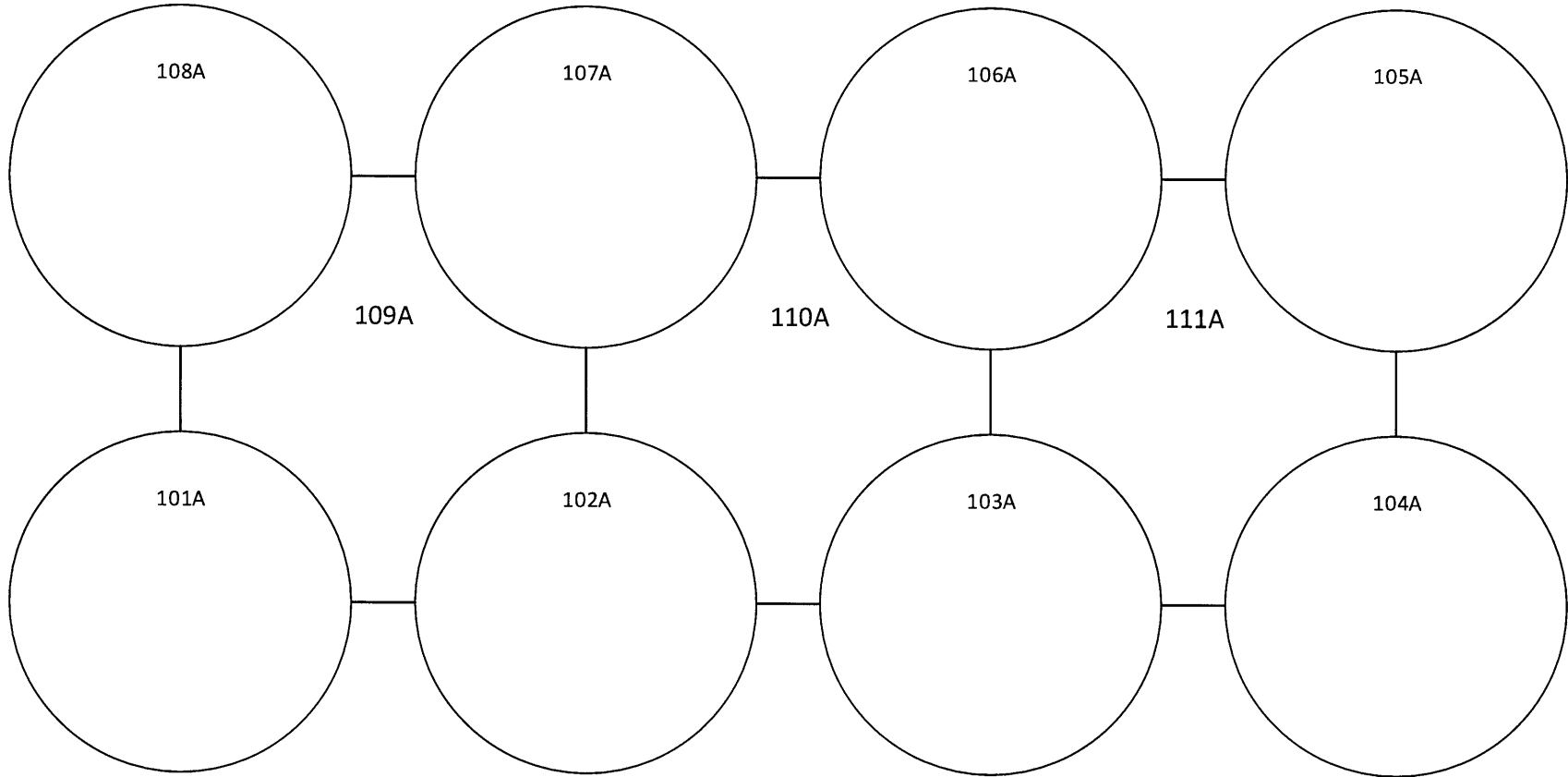

**Concrete silo – 34.0' diameter
729.8 bu/ft
Depth (140.5' less 3.0' floor) = 137.5'**

**Interstice bins – 181.6 bu./ft
Depth - 137.5'**

Fessenden Co-op Association
Section 1A
Main Plant Bulk Warehouse
#006

Base Dimensions

200.00' L x 60.0' W
Bottom of overhead center drag to floor 25.7'
Overhead horizontal brace rods to floor 17.2'
Main side wall beams and rafters 20.00' center to center

Side wall get top of to floor

1st gert 1.3'
2nd gert 2.4'
3rd gert 3.8'
4th gert 5.4'
5th girt 7.2'
6th gert 9.0'
7th gert 11.3'
8th gert 13.6'
9th gert 15.9'
10th and side wall ht. 18.4'

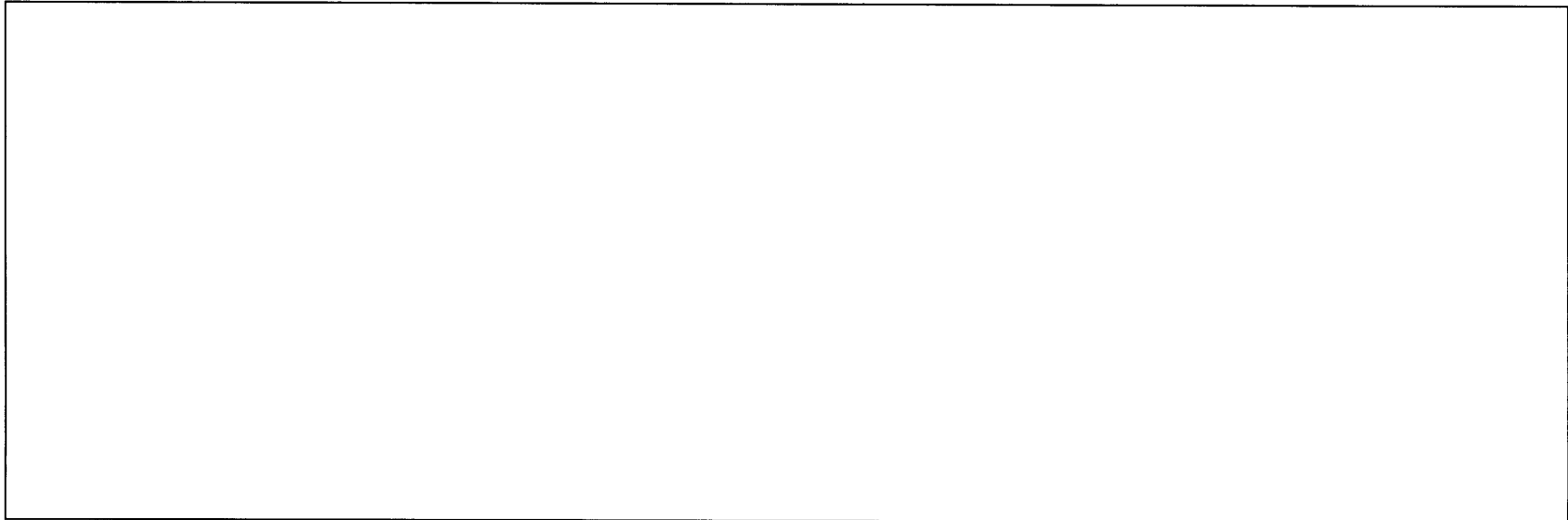

Fessenden Co-op Association
Section 1B
#001

Base Dimensions

Outside dimensions 120' x 60'

Inside dimensions 118.6' L x 58.6' W

Grain wall height 4.5' – grain wall thickness 0.6'

Bottom of overhead center rafter to floor 15.75'

Bottom of lowest angle iron support on conveyor to floor 20.5'

Main side wall beams & rafters center to center ???

Capacity 45,000 bu. Calculated with average grain depth of 8.0'

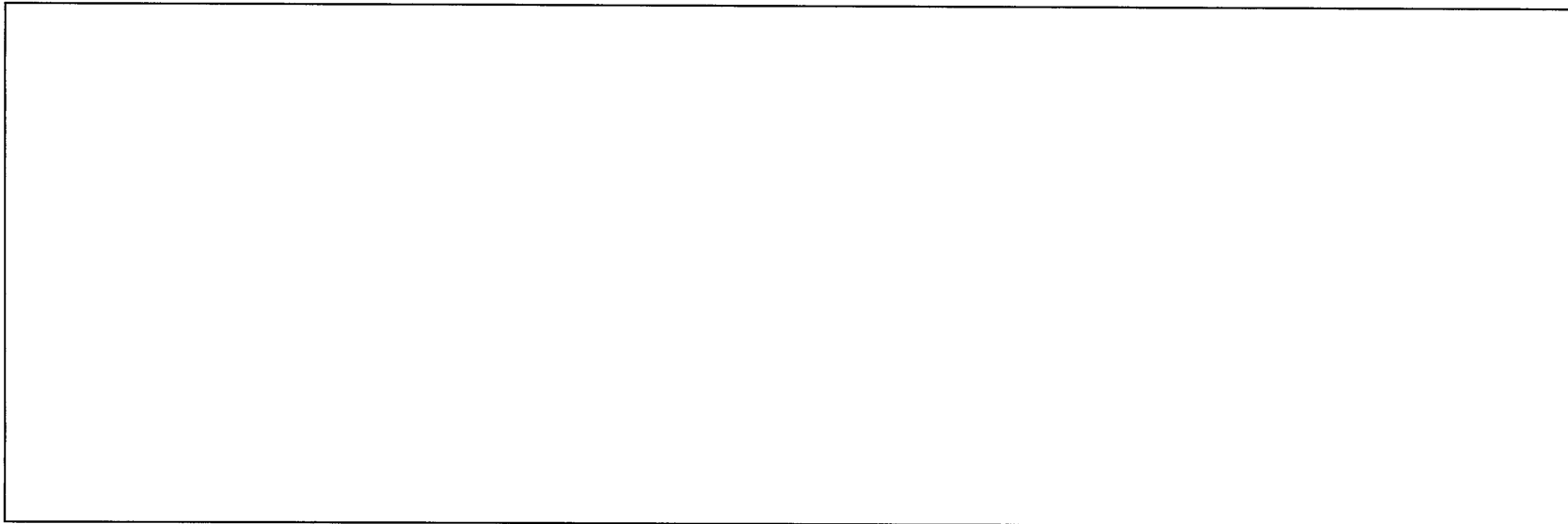

Fessenden Co-op Association
Section 1B
#002

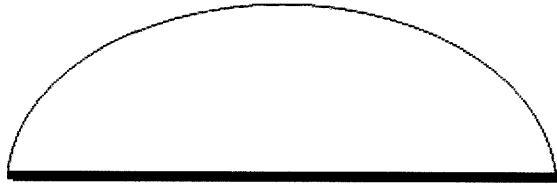

11.0' = 57.5'
9.0' ht. width = 60.2'
7.0' ht. width = 62.5'
5.0' ht. width = 64.7'
3.0' ht. width = 66.7'
Foundation 66.7'W x 2.0' ht.

Base Dimensions

Foundation 2.0' H. x 66.7' W x 122.8' L

Outside dimensions 68.0' W x 124.0' L

Inside steel base above foundation 67.5' W x 123.7' L

Horizontal side wall braces top of to floor

1 st brace	8.1'	4 th brace	22.0'
2 nd brace	13.9'	5 th brace	24.2'
3 rd brace	18.2'	6 th and center overhead	24.8'

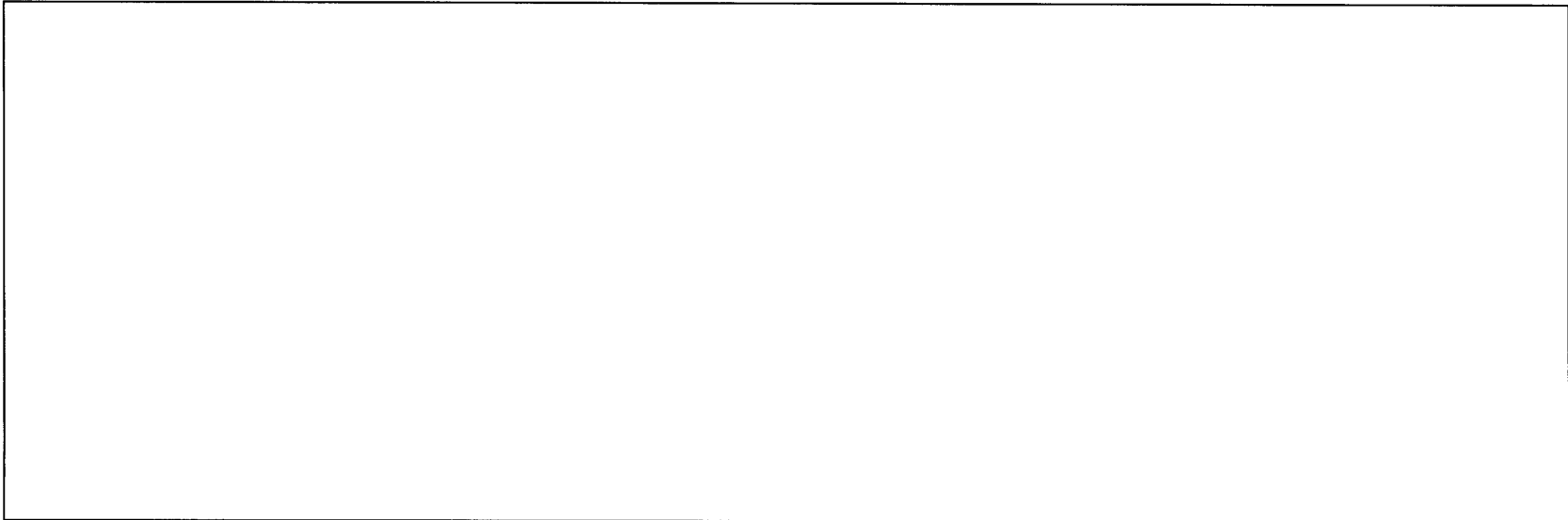

Fessenden Co-op Association

Bean Plant

Section 1A

Section 1B

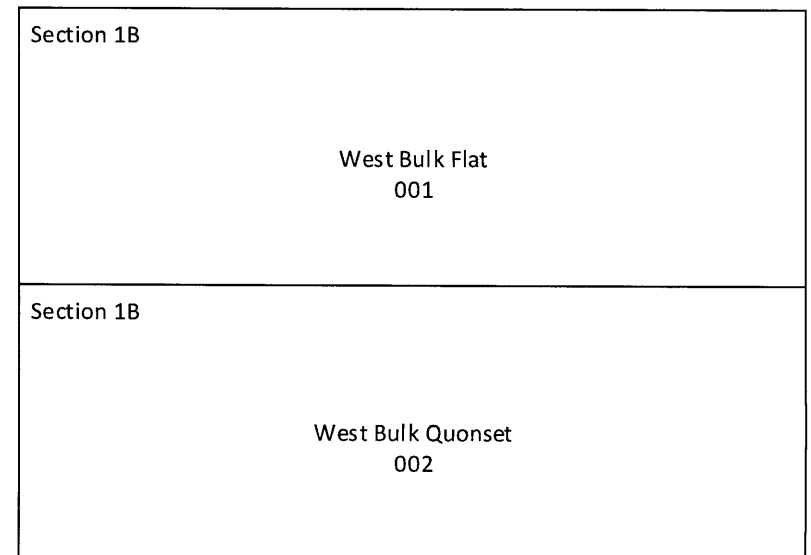
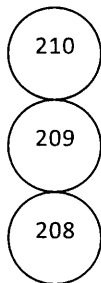
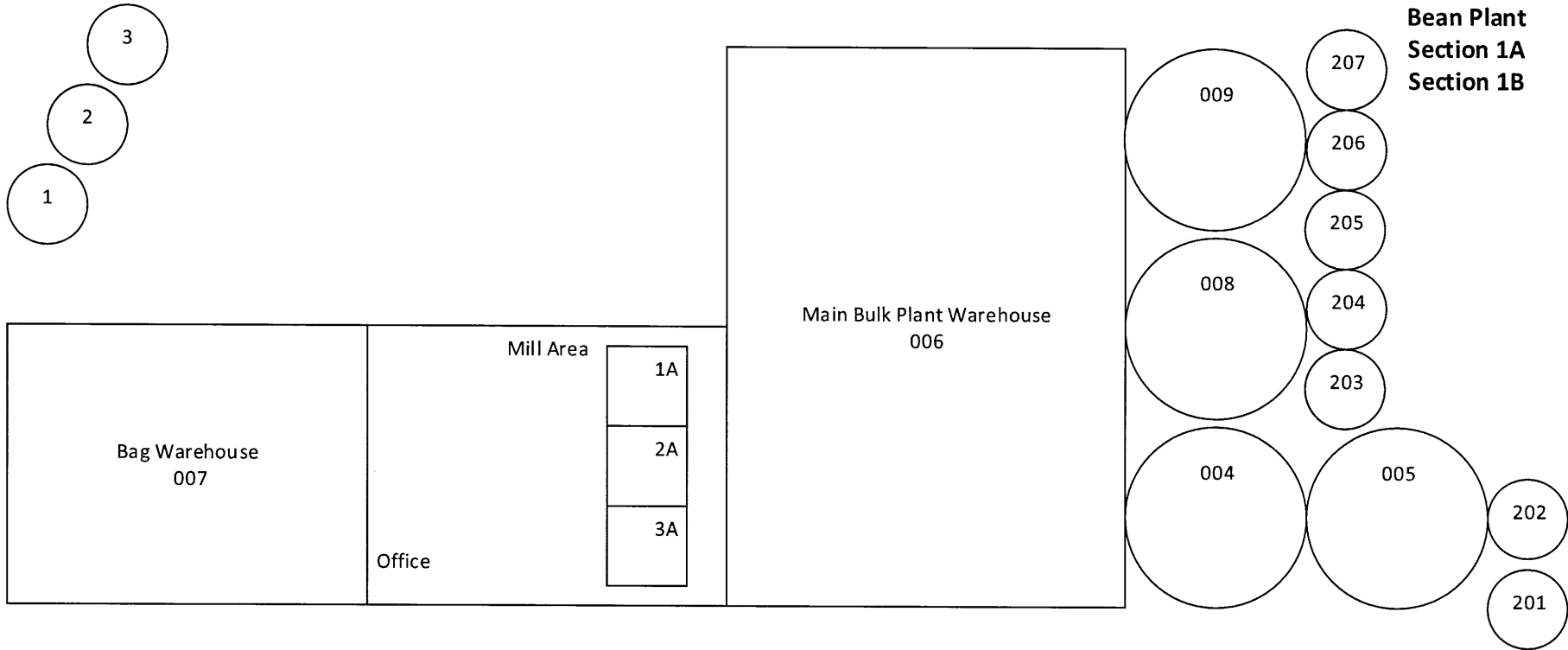

Harlow Co-Op
Elevator and Seed
Harlow ND
Section B & C

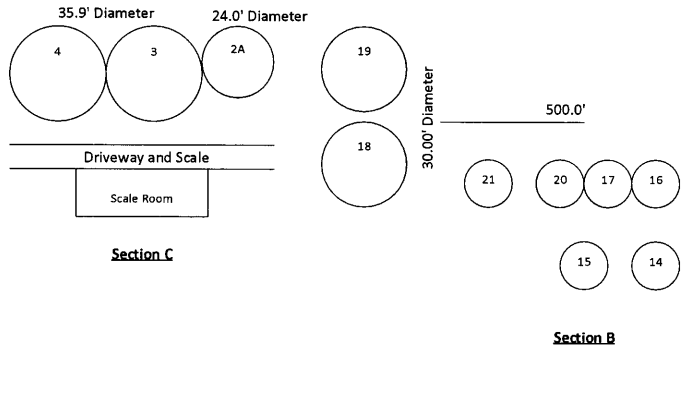

Section C

Section B

Section E

Page Break

Page Break

Harlow Co-Op
Elevator and Seed
Harlow ND
Section A

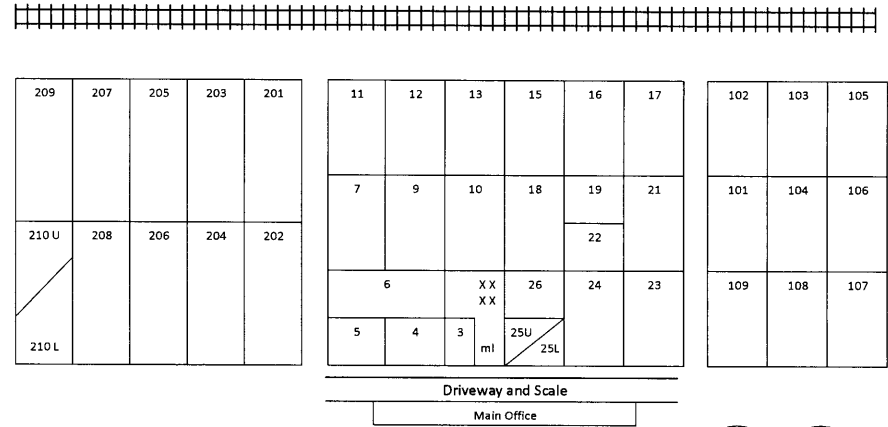

Zero: Floor over bins; Tanks top of Sidewall
Note: Measure 210L (blind bin) through u-trough.
(u-trough to bottom of bin is 64.0')



Fessenden Co-op
Heimdahl Station
Section C

115	117	118	116	114	112
109	111	113	110	108	106
107	105	103	101	102	104
		XX	ml		

015	014	011	010
	Scale		
016	013	008	009
017	018	002	005
	001	XX	003
022		XX	004
	020		

Driveway and Scale



201	205	206	210	211	218	216
	204		209		217	
202	203	207	208	212	213	215
						214

Fessenden Co-op Association
Section D
Hamberg

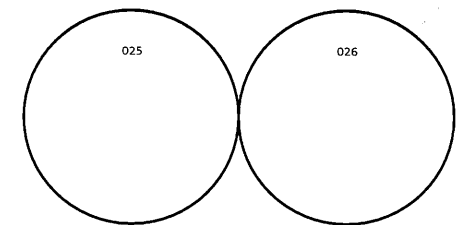
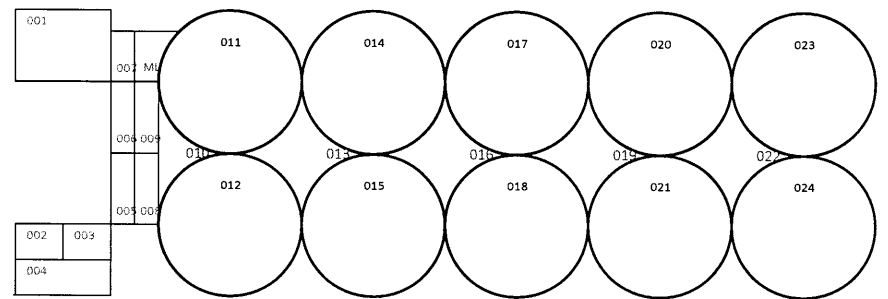
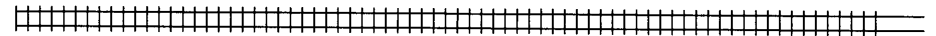

Silo Annex located North of Main Complex

Fessenden Co-op Association
Harlow ND
Section E
Concrete Complex

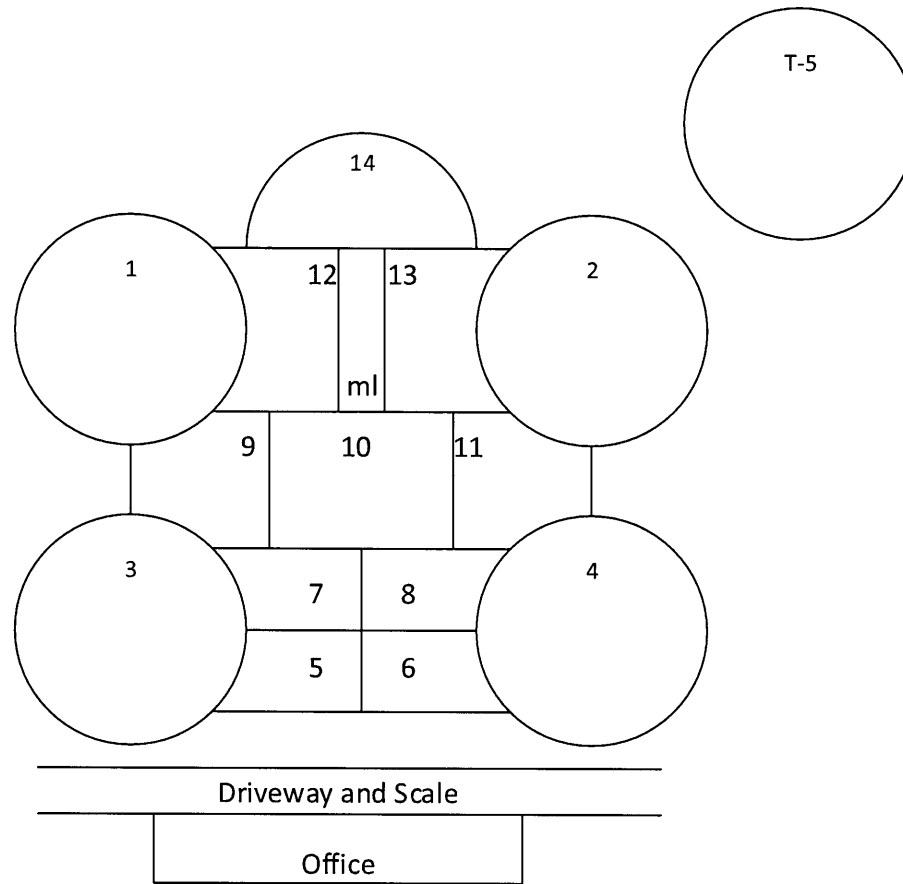

SEED Hoppers

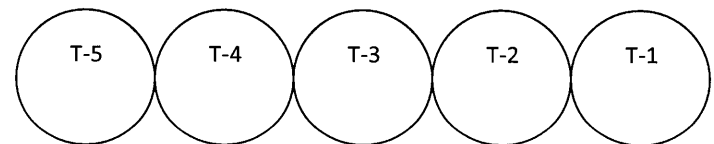

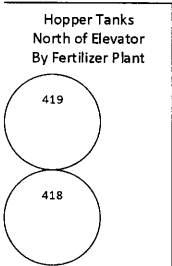

Fessenden Coop Association
Esmond Station
Section G

010	015	012	013
008	006	009	011
004	002	001	005

110	115	112	113
108	106	109	111
104	102T 102B	XX XX	105

207	206	205
201	202	203

Office	003	
--------	-----	--

Page Break



Fessenden Coop Association
Esmond Station
Section G

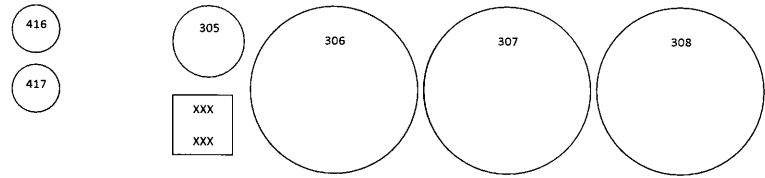

Page Break

Fessenden Co-op Association
 Carrington Station
 Section J
 Bird Food Plant

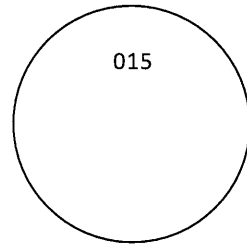

014
 Flat Storage
 48.5' W x 123.5' L x 11.0' H
 Bottom center rafter to floor 18.5'

Rail Car Siding

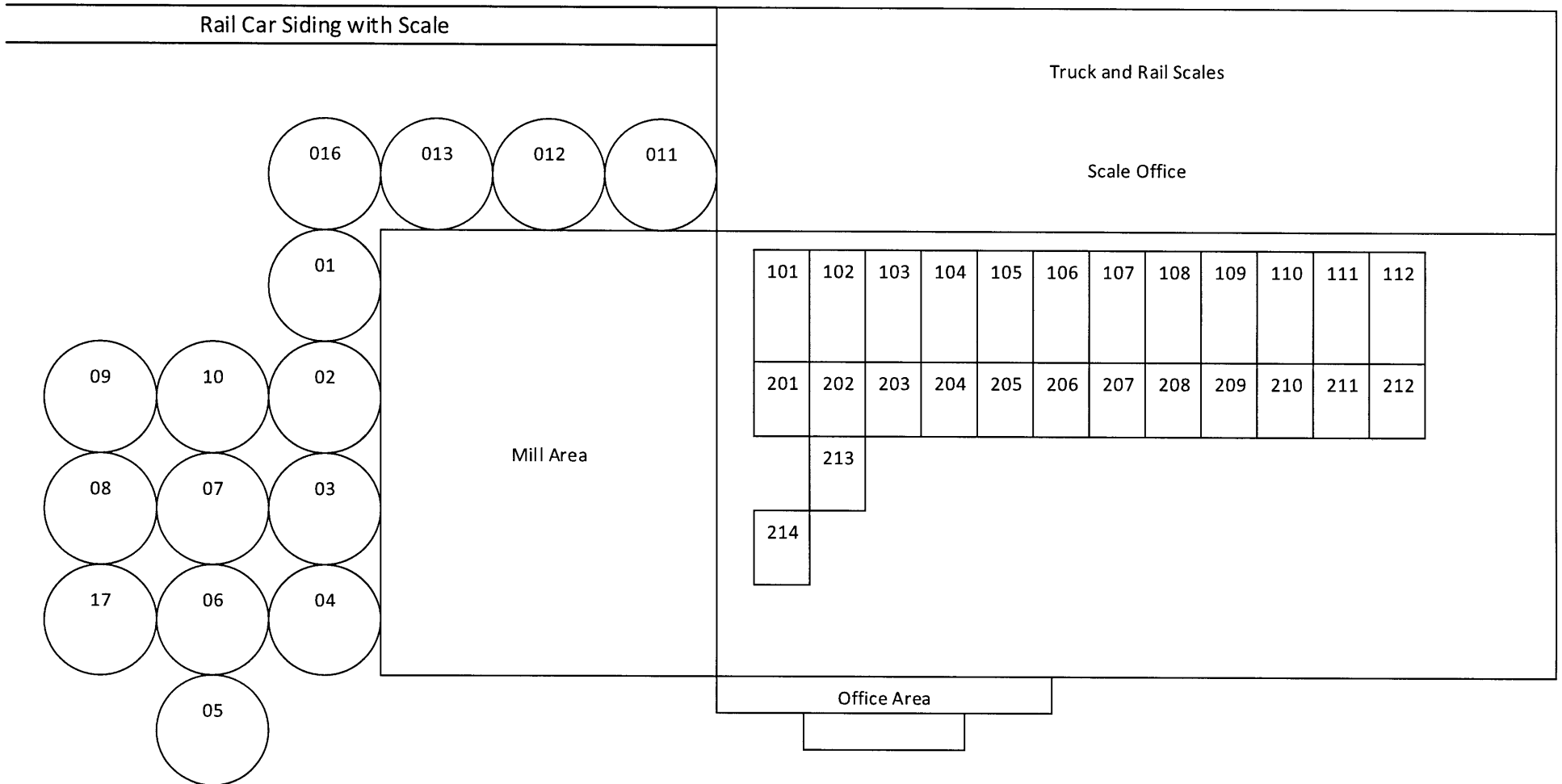

Fessenden Co-op Association
Section K
Central City Grain
Carrington ND

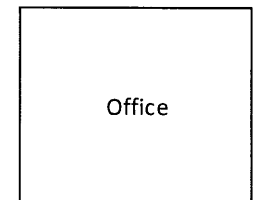
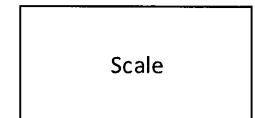
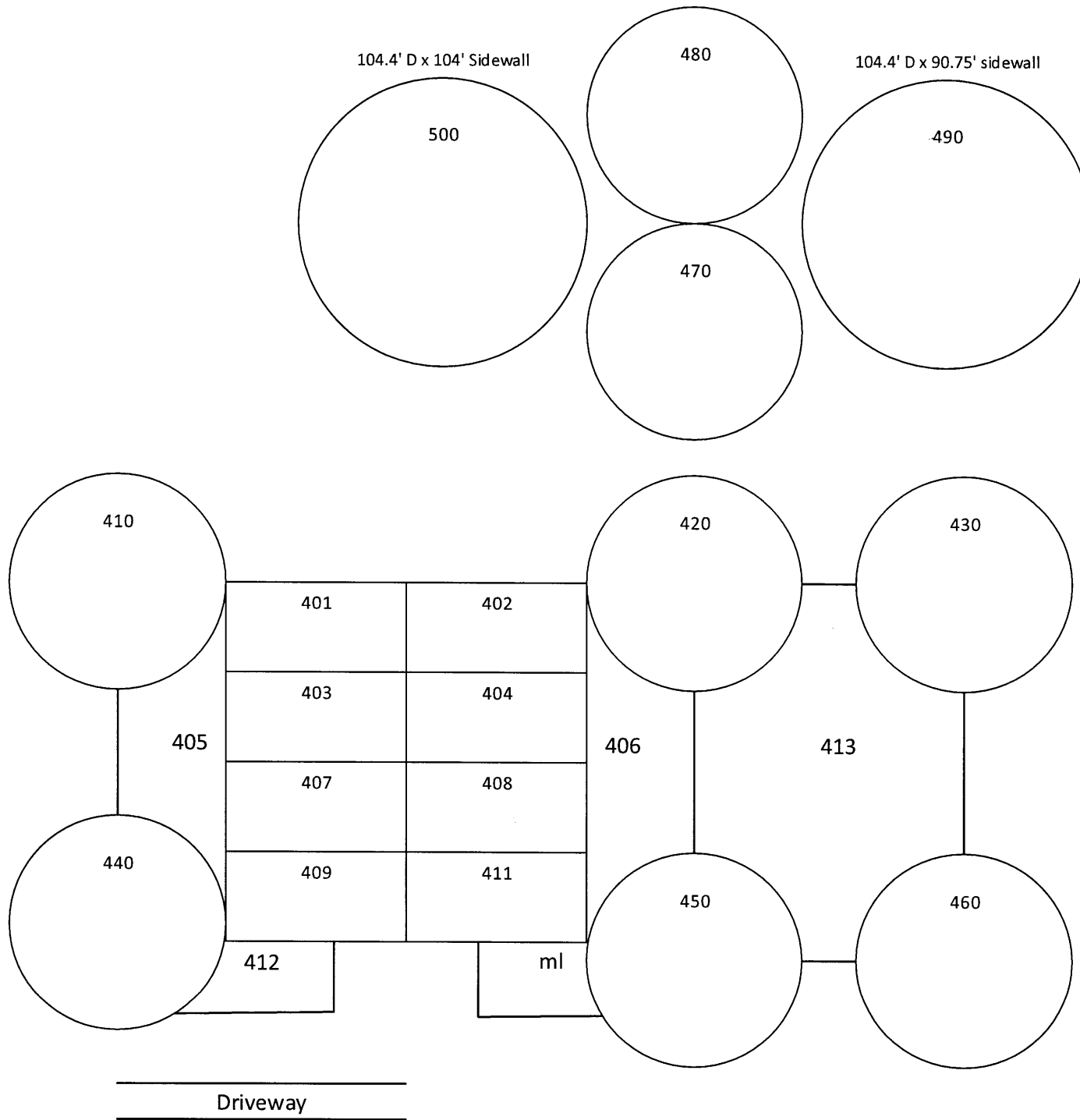

Fessenden Co-op Association
 Section J
 Maddock East Complex

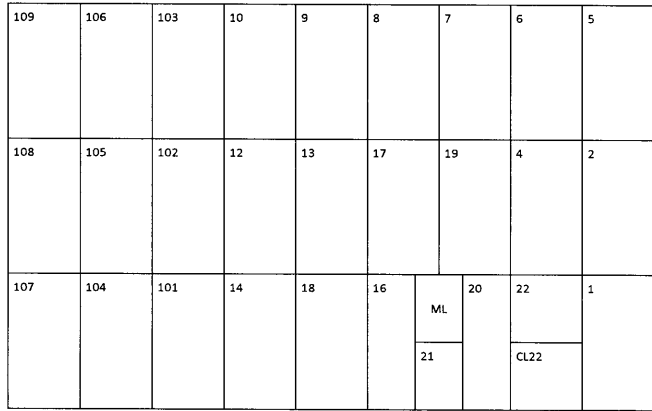
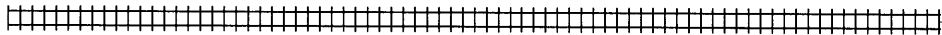

Driveway and Scale

Scale Room

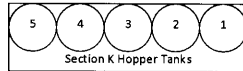

Fessenden Co-op Association
 Section K
 Maddock West Complex

