

Exam Date:08/14/2018

Central Valley Bean Cooperative

Page: 1

Examiner: 1

PO Box 162

Buxton , ND

County:

Phone: 701-847-2622

CCC Number:

Location/Container Numbers/Comments	Section	Capacity
-------------------------------------	---------	----------

**PART A - ADDITIONAL SPACE TO BE INCLUDED UNDER LICENSE**

<NO BINS ADDED>

<b>Total:</b>	<b>0</b>
---------------	----------

**PART B - SPACE TO BE DELETED UNDER LICENSE**

602 R-sou	F	74,309
609-1	F	27,575
903	K	51,730
		<b>Total:</b>
		<b>153,614</b>

**PART C - ALL SPACE TO BE INCLUDED UNDER LICENSE**

A	86,000
B	816,000
D	1,352,000
E	127,000
F	176,000
K	52,000
M	39,000
N	17,000
P	124,000
REB	4,000
REH	20,000
REL	93,000
RES	8,000
REW	36,000
REX	24,000
	<b>Total:</b>
	<b>2,974,000</b>

**PART D - TOTAL CAPACITY BY FUNCTIONAL UNIT**

	A	B	D	E	F	K	REB	REH	REL	RES	REW	REX	
Buxton 126													2,794,000
Devils Lake 1211	M												39,000
Lankin 1213	N												17,000
Pisek 1214	P												124,000
													<b>Total:</b>
													<b>2,974,000</b>

### NDPSC Bin Capacity Chart

Exam Date:08/14/2018  
 Examiner: 1

Central Valley Bean Cooperative  
 PO Box 162  
 Buxton , ND  
 County:

Status	Section	Bin Number	Bin Type	Base Point	Diameter or Bu/Ft (Irreg.)		Side wall	Add for Hopper	Ded. for Obst.	Effective Depth	Add for Peak	Depth for Capac.	Bushels per Foot	Base Pack%	Bushel Capacity with Pack	
					Length	Width										
	<b>A</b>	001	Square	top of bin at side wall	0.000	10.00	10.00	38.00	2.00	0.00	40.000	0.000	40.0	80.4	5.50	3,393
	A	002	Square	top of bin at side wall	0.000	10.00	10.00	38.00	2.00	0.00	40.000	0.000	40.0	80.4	5.50	3,393
	A	003	Square	top of bin at side wall	0.000	10.00	10.00	38.00	2.00	0.00	40.000	0.000	40.0	80.4	5.50	3,393
	A	004	Square	top of bin at side wall	0.000	10.00	6.500	38.00	2.00	0.00	40.000	0.000	40.0	52.3	4.50	2,186
	A	005	Square	top of bin at side wall	0.000	10.00	10.00	38.00	2.00	0.00	40.000	0.000	40.0	80.4	5.50	3,393
	A	006	Square	top of bin at side wall	0.000	10.00	10.00	38.00	2.00	0.00	40.000	0.000	40.0	80.4	5.50	3,393
	A	007	Square	top of bin at side wall	0.000	10.00	10.00	25.00	3.70	0.00	28.700	0.000	28.7	80.4	5.50	2,434
	A	008	Square	top of bin at side wall	0.000	10.00	10.00	25.00	3.70	0.00	28.700	0.000	28.7	80.4	5.50	2,434
	A	009	Square	top of bin at side wall	0.000	10.00	10.00	25.00	3.70	0.00	28.700	0.000	28.7	80.4	5.50	2,434
	A	010	Square	top of bin at side wall	0.000	10.00	10.00	25.00	3.70	0.00	28.700	0.000	28.7	80.4	5.50	2,434
	A	111	Flat	bag storage	0.000	214.0	60.00	5.000	0.00	0.00	5.000	0.000	5.0	10321.5	10.0	56,769

Bin count: 11

Facility: Buxton Section: A Total: **85,656**

To Even: **86,000**

### Section: B

	B	201	Peaked	eave at sidewall	33.000	0.000	0.000	47.70	0.00	0.00	47.700	2.000	49.7	687.5	9.50	37,415
	B	202	Peaked	eave at sidewall	36.000	0.000	0.000	47.70	0.00	0.00	47.700	2.200	49.9	818.2	10.0	44,911
	B	203	Peaked	eave at sidewall	36.000	0.000	0.000	47.70	0.00	0.00	47.700	2.200	49.9	818.2	10.0	44,911
	B	204	Peaked	eave at sidewall	36.000	0.000	0.000	47.70	0.00	0.00	47.700	2.200	49.9	818.2	10.0	44,911
	B	205	Peaked	eave at sidewall	53.300	0.000	0.000	51.30	0.00	0.00	51.300	3.700	55.0	1793.6	10.0	108,513
	B	206	Peaked	eave at sidewall	53.300	0.000	0.000	51.30	0.00	0.00	51.300	3.700	55.0	1793.6	10.0	108,513
	B	207	Peaked	eave at sidewall	53.300	0.000	0.000	51.30	0.00	0.00	51.300	3.700	55.0	1793.6	10.0	108,513
	B	208	Peaked	eave at sidewall	53.300	0.000	0.000	50.00	0.00	0.00	50.000	3.700	53.7	1793.6	10.0	105,948

**NDPSC Bin Capacity Chart**

Exam Date:08/14/2018  
 Examiner: 1

Central Valley Bean Cooperative  
 PO Box 162  
 Buxton , ND  
 County:

Status	Section	Bin Number	Bin Type	Base Point	Diameter or Bu/Ft (Irreg.)		Side wall	Add for Hopper	Ded. for Obst.	Effective Depth	Add for Peak	Depth for Capac.	Bushels per Foot	Base Pack%	Bushel Capacity with Pack	
					Length	Width										
<b>Section: B</b>																
	B	209	Peaked	eave at sidewall	53.300	0.000	0.000	50.00	0.00	0.00	50.000	3.700	53.7	1793.6	10.0	105,948
	B	210	Peaked	eave at sidewall	53.300	0.000	0.000	50.00	0.00	0.00	50.000	3.700	53.7	1793.6	10.0	105,948
Bin count: 10													<b>Facility: Buxton Section: B Total:</b>			<b>815,531</b>
													<b>To Even:</b>			<b>816,000</b>

**Section: D**

	D	011	Peaked	eave at sidewall	59.800	0.000	0.000	50.20	0.00	0.00	50.200	4.200	54.4	2257.7	10.0	135,101
	D	012	Peaked	eave at sidewall	59.800	0.000	0.000	50.20	0.00	0.00	50.200	4.200	54.4	2257.7	10.0	135,101
	D	013	Peaked	eave at sidewall	59.800	0.000	0.000	50.20	0.00	0.00	50.200	4.200	54.4	2257.7	10.0	135,101
	D	014	Peaked	eave at sidewall	59.800	0.000	0.000	50.20	0.00	0.00	50.200	4.200	54.4	2257.7	10.0	135,101
	D	015	Peaked	eave at sidewall	59.800	0.000	0.000	50.20	0.00	0.00	50.200	4.200	54.4	2257.7	10.0	135,101
	D	016	Peaked	eave at sidewall	59.800	0.000	0.000	50.20	0.00	0.00	50.200	4.200	54.4	2257.7	10.0	135,101
	D	017	Peaked	eave at sidewall	59.800	0.000	0.000	50.20	0.00	0.00	50.200	4.200	54.4	2257.7	10.0	135,101
	D	018	Peaked	eave at sidewall	59.800	0.000	0.000	50.20	0.00	0.00	50.200	4.200	54.4	2257.7	10.0	135,101
	D	019	Peaked	eave at sidewall	59.800	0.000	0.000	50.20	0.00	0.00	50.200	4.200	54.4	2257.7	10.0	135,101
	D	020	Peaked	eave at sidewall	59.800	0.000	0.000	50.20	0.00	0.00	50.200	4.200	54.4	2257.7	10.0	135,101
Bin count: 10													<b>Facility: Buxton Section: D Total:</b>			<b>1,351,010</b>
													<b>To Even:</b>			<b>1,352,000</b>

**Section: E**

	E	501	Flat		0.000	120.0	60.00	18.00	0.00	0.00	18.000	0.000	18.0	5787.8	10.0	114,598
	E	502	Peaked	top of sidewall new navy	16.000	0.000	0.000	20.00	2.35	0.00	22.350	1.000	23.4	161.6	5.80	4,000

### NDPSC Bin Capacity Chart

Exam Date:08/14/2018

Central Valley Bean Cooperative  
 PO Box 162  
 Buxton , ND  
 County:

Examiner: 1

Status	Section	Bin Number	Bin Type	Base Point	Diameter or Bu/Ft (Irreg.)		Side wall	Add for Hopper	Ded. for Obst.	Effective Depth	Add for Peak	Depth for Capac.	Bushels per Foot	Base Pack%	Bushel Capacity with Pack
--------	---------	------------	----------	------------	----------------------------	--	-----------	----------------	----------------	-----------------	--------------	------------------	------------------	------------	---------------------------

## Section: E

E	503	Peaked	top of sidewall new navy	16.000	0.000	0.000	20.00	2.35	0.00	22.350	1.000	23.4	161.6	5.80	4,000
E	504	Peaked	top of sidewall new navy	16.000	0.000	0.000	20.00	2.35	0.00	22.350	1.000	23.4	161.6	5.80	4,000

Bin count: 4

Facility: Buxton Section: E Total: **126,598**

To Even: **127,000**

## Section: F

F	601 R-no	Quonset	sidewall brace to floor 10.3	0.000	120.0	60.00	12.00	0.00	0.00	12.000	0.000	12.0	5629.5	10.0	74,309
F	604	Flat	kuster west warehouse	0.000	95.00	46.00	12.00	0.00	0.00	12.000	0.000	12.0	3512.9	10.0	46,371
F	609-2	Flat	Reynolds Galegher north	0.000	94.50	33.00	10.00	0.00	0.00	10.000	0.000	10.0	2506.8	10.0	27,575
F	609-3	Flat	Reynolds Galegher north	0.000	94.50	33.00	10.00	0.00	0.00	10.000	0.000	10.0	2506.8	10.0	27,575

Bin count: 4

Facility: Buxton Section: F Total: **175,830**

To Even: **176,000**

## Section: K

K	904	Quonset	clem moger west	0.000	118.7	48.50	10.50	0.00	0.00	10.500	0.000	10.5	4478.8	10.0	51,730
---	-----	---------	-----------------	-------	-------	-------	-------	------	------	--------	-------	------	--------	------	--------

Bin count: 1

Facility: Buxton Section: K Total: **51,730**

To Even: **52,000**

## Section: M

M	001	Peaked	Devils Lake Receiving	16.000	35.27	35.27	25.00	2.35	0.00	27.350	1.000	28.4	161.6	5.80	4,855
M	002	Peaked	Devils Lake Receiving	16.000	35.27	35.27	25.00	2.35	0.00	27.350	1.000	28.4	161.6	5.80	4,855
M	003	Peaked	Devils Lake Receiving	16.000	35.27	35.27	25.00	2.35	0.00	27.350	1.000	28.4	161.6	5.80	4,855

### NDPSC Bin Capacity Chart

Exam Date:08/14/2018

Central Valley Bean Cooperative  
 PO Box 162  
 Buxton, ND  
 County:

Examiner: 1

Status	Section	Bin Number	Bin Type	Base Point	Diameter or Bu/Ft (Irreg.)	Length	Width	Side wall	Add for Hopper	Ded. for Obst.	Effective Depth	Add for Peak	Depth for Capac.	Bushels per Foot	Base Pack%	Bushel Capacity with Pack
--------	---------	------------	----------	------------	-------------------------------	--------	-------	--------------	----------------------	----------------------	--------------------	--------------------	------------------------	------------------------	---------------	------------------------------

## Section: M

M	004	Peaked	Devils Lake Receiving	16.000	35.27	35.27	25.00	2.35	0.00	27.350	1.000	28.4	161.6	5.80	4,855
M	005	Peaked	Devils Lake Receiving	16.000	35.27	35.27	25.00	2.35	0.00	27.350	1.000	28.4	161.6	5.80	4,855
M	006	Peaked	Devils Lake Receiving	16.000	35.27	35.27	25.00	2.35	0.00	27.350	1.000	28.4	161.6	5.80	4,855
M	007	Peaked	Devils Lake Receiving	16.000	35.27	35.27	25.00	2.35	0.00	27.350	1.000	28.4	161.6	5.80	4,855
M	008	Peaked	Devils Lake Receiving	16.000	35.27	35.27	25.00	2.35	0.00	27.350	1.000	28.4	161.6	5.80	4,855

Bin count: 8

Facility: Devils Lake Section: M Total: **38,840**

To Even: **39,000**

## Section: N

N	100	Irregular	Lankin receiving-4 tanks	1000.0	35.27	35.27	14.60	0.00	0.00	14.600	0.000	14.6	1000.0	10.0	16,060
---	-----	-----------	--------------------------	--------	-------	-------	-------	------	------	--------	-------	------	--------	------	--------

Bin count: 1

Facility: Lankin Section: N Total: **16,060**

To Even: **17,000**

## Section: P

P	100	Quonset	Pisek quonset	0.000	199.0	60.30	10.00	0.00	0.00	10.000	0.000	10.0	9466.1	10.0	104,127
P	101	Peaked	Pisek quonset	16.000	0.000	0.000	25.00	2.35	0.00	27.350	1.000	28.4	161.6	5.80	4,855
P	102	Peaked	Pisek quonset	16.000	0.000	0.000	25.00	2.35	0.00	27.350	1.000	28.4	161.6	5.80	4,855
P	103	Peaked	Pisek quonset	16.000	0.000	0.000	25.00	2.35	0.00	27.350	1.000	28.4	161.6	5.80	4,855
P	104	Peaked	Pisek quonset	16.000	0.000	0.000	25.00	2.35	0.00	27.350	1.000	28.4	161.6	5.80	4,855

Bin count: 5

Facility: Pisek Section: P Total: **123,547**

To Even: **124,000**

### NDPSC Bin Capacity Chart

Exam Date:08/14/2018

Central Valley Bean Cooperative  
 PO Box 162  
 Buxton , ND  
 County:

Examiner: 1

Status	Section	Bin Number	Bin Type	Base Point	Diameter or Bu/Ft (Irreg.)	Length	Width	Side wall	Add for Hopper	Ded. for Obst.	Effective Depth	Add for Peak	Depth for Capac.	Bushels per Foot	Base Pack%	Bushel Capacity with Pack
--------	---------	------------	----------	------------	----------------------------	--------	-------	-----------	----------------	----------------	-----------------	--------------	------------------	------------------	------------	---------------------------

### Section: REB

REB	001	Peaked	Barlow		16.000	0.000	0.000	20.00	2.00	0.00	22.000	1.000	23.0	161.6	5.80	3,933
-----	-----	--------	--------	--	--------	-------	-------	-------	------	------	--------	-------	------	-------	------	-------

Bin count: 1

Facility: Buxton Section: REB Total: 3,933

To Even: 4,000

### Section: REH

REH	005	Peaked	Hatton receiving-4 hoppers		16.000	35.27	35.27	25.00	2.35	0.00	27.350	1.000	28.4	161.6	5.80	4,855
REH	006	Peaked	Hatton receiving-4 hoppers		16.000	35.27	35.27	25.00	2.35	0.00	27.350	1.000	28.4	161.6	5.80	4,855
REH	007	Peaked	Hatton receiving-4 hoppers		16.000	35.27	35.27	25.00	2.35	0.00	27.350	1.000	28.4	161.6	5.80	4,855
REH	008	Peaked	Hatton receiving-4 hoppers		16.000	35.27	35.27	25.00	2.35	0.00	27.350	1.000	28.4	161.6	5.80	4,855

Bin count: 4

Facility: Buxton Section: REH Total: 19,420

To Even: 20,000

### Section: REL

REL	B-001	Peaked	Alliance Vily Lrmre- top of		24.000	0.000	0.000	24.00	3.70	0.00	27.700	1.400	29.1	363.7	7.80	11,410
REL	B-002	Peaked	Alliance Vily Lrmre- top of		24.000	0.000	0.000	24.00	3.70	0.00	27.700	1.400	29.1	363.7	7.80	11,410
REL	B-014	Peaked	Alliance Vily Lrmre- top of		48.000	0.000	0.000	40.30	0.00	0.00	40.300	3.400	43.7	1454.6	10.0	69,923

Bin count: 3

Facility: Buxton Section: REL Total: 92,743

To Even: 93,000

### Section: RES

RES	102	Peaked	Alliance Vily Shrn- top of		16.000	0.000	0.000	20.00	2.00	0.00	22.000	1.000	23.0	161.6	5.80	3,933
RES	103	Peaked	Alliance Vily Shrn- top of		16.000	0.000	0.000	20.00	2.00	0.00	22.000	1.000	23.0	161.6	5.80	3,933

## NDPSC Bin Capacity Chart

Exam Date: 08/14/2018

Central Valley Bean Cooperative  
PO Box 162  
Buxton, ND  
County:

Examiner: 1

Status	Section	Bin Number	Bin Type	Base Point	Diameter or Bu/Ft (Irreg.)	Length	Width	Side wall	Add for Hopper	Ded. for Obst.	Effective Depth	Add for Peak	Depth for Capac.	Bushels per Foot	Base Pack%	Bushel Capacity with Pack
--------	---------	------------	----------	------------	-------------------------------	--------	-------	--------------	----------------------	----------------------	--------------------	--------------------	------------------------	------------------------	---------------	------------------------------

**Bin count: 2**

**Facility: Buxton Section: RES Total: 7,866**

**To Even: 8,000**

### Section: REW

REW 105	Flat	Washburn receiving flat	0.000	40.00	100.0	9.900	0.00	0.00	9.900	0.000	9.9	3215.4	10.0	35,015
---------	------	-------------------------	-------	-------	-------	-------	------	------	-------	-------	-----	--------	------	--------

**Bin count: 1**

**Facility: Buxton Section: REW Total: 35,015**

**To Even: 36,000**

### Section: REX

REX 001	Peaked	Wilton Recieving Farmers	16.000	0.000	0.000	25.00	3.00	0.00	28.000	1.000	29.0	161.6	5.80	4,958
REX 002	Peaked	Wilton Recieving Farmers	16.000	0.000	0.000	25.00	3.00	0.00	28.000	1.000	29.0	161.6	5.80	4,958
REX 003	Peaked	Wilton Recieving Farmers	16.000	0.000	0.000	25.00	3.00	0.00	28.000	1.000	29.0	161.6	5.80	4,958
REX 004	Peaked	Wilton Recieving Farmers	16.000	0.000	0.000	25.00	3.00	0.00	28.000	1.000	29.0	161.6	5.80	4,958
REX 005	Peaked	Wilton Recieving Farmers	16.000	0.000	0.000	20.00	2.40	0.00	22.400	1.000	23.4	161.6	5.80	4,000

**Bin count: 5**

**Facility: Buxton Section: REX Total: 23,832**

**To Even: 24,000**

**Overall Licensed Bin Capacity for:**

**Central Valley Bean Cooperative**

**Bin count: 70**

**Licensed Capacity:**

(includes pack)

**2,967,611 Bu.**

**Licensed Capacity (to even):**

(includes pack and section totals are rounded up to next highest 1000)

**2,974,000 Bu.**

CENTRAL VALLEY BEAN  
 CO-OP CORP# 257  
 BUXTON ND

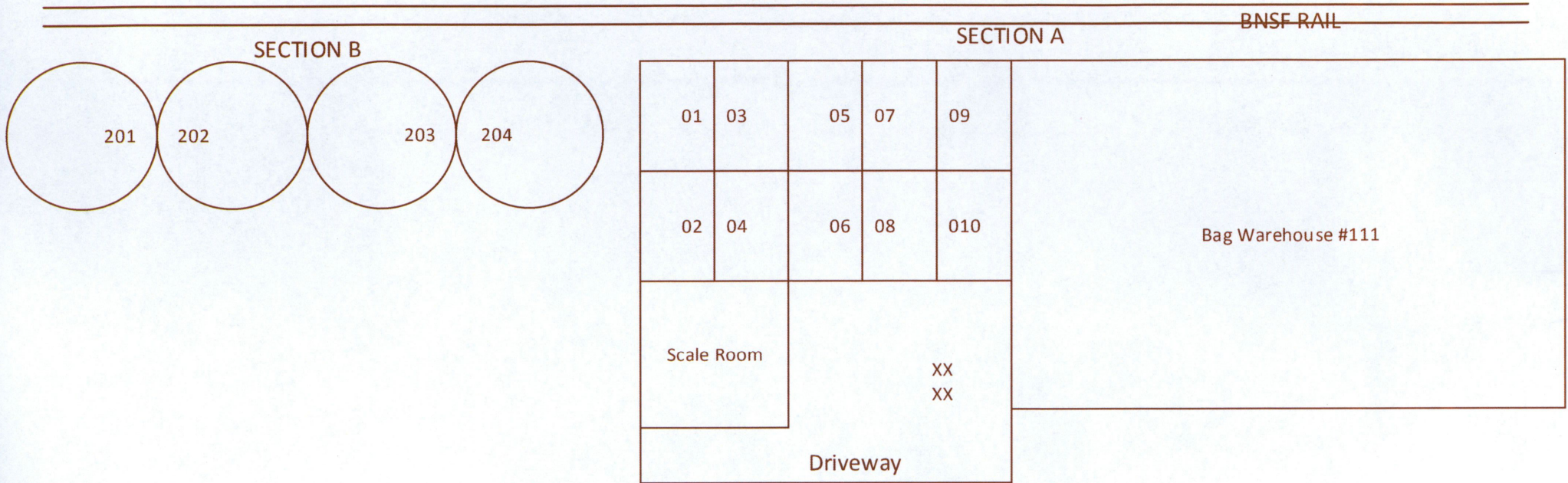

- Section E Navy bean flat & 3  
hoppers
- Section F all storage located  
in Reynolds
- Section J all storage located  
rural east of Reynolds
- Section K Moger quonsets  
south of Buxton
- Section M – Devils Lake
- Section L – Lakota
- Section N – Lankin
- Section P – Pisek
- Section Z – receiving stations  
at Hatton-Larimore-  
Washburn

Street

XX  
 XX

Section B see page 2

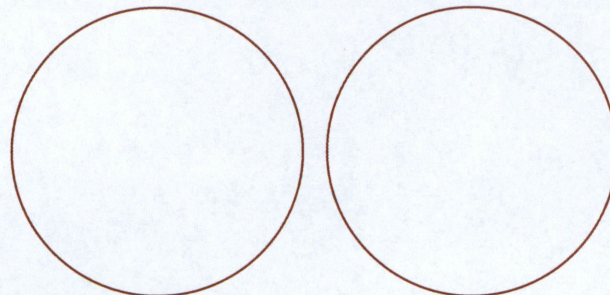

CENTRAL VALLEY BEAN  
CO-OP CORP# 257  
BUXTON ND  
Updated 8/2/18 PH

Processing Plant see page 1

North to Scale & Scale Office

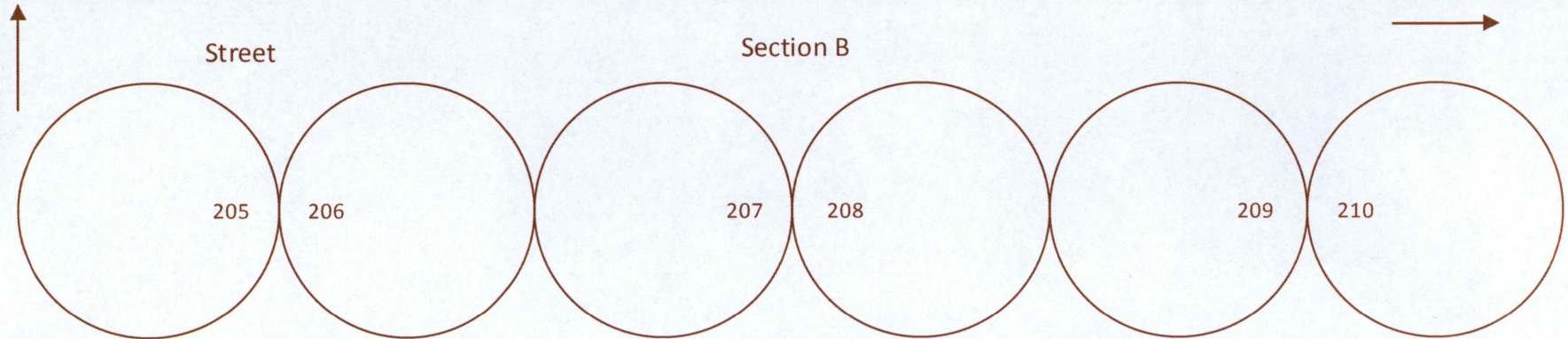

Driveway & Dump site

Section D

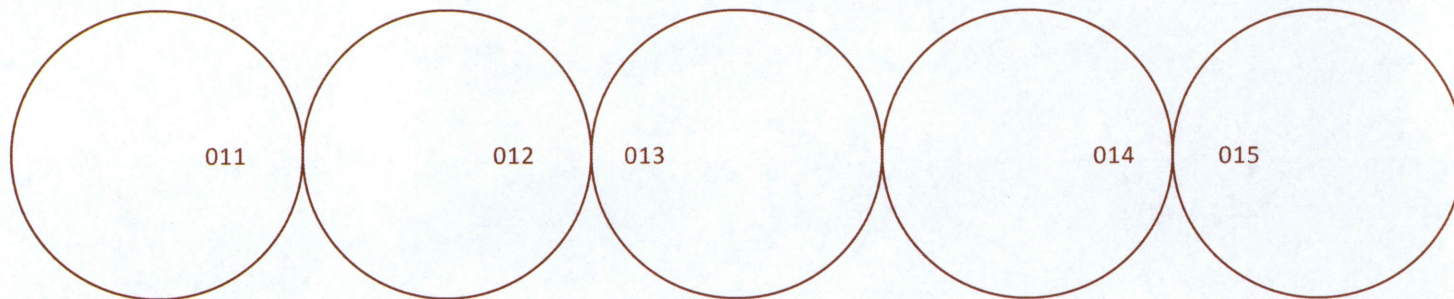

CENTRAL VALLEY BEAN  
CO-OP CORP# 257  
BUXTON ND  
Section E

Basic dimensions #501  
Foundation 58.0'W x 118.0'L  
x 2.0' ht.  
Metal base 60.0'W x 120.0'L  
Sidewall gerts top to floor  
1<sup>st</sup> = 2.9' - 2<sup>nd</sup> = 3.7' - 3<sup>rd</sup> = 5.0'  
4<sup>th</sup> = 6.7' - 5<sup>th</sup> = 9.5' - 6<sup>th</sup> =  
12.0' top of sidewall 19.3'

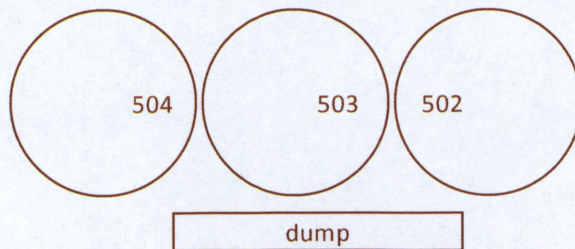
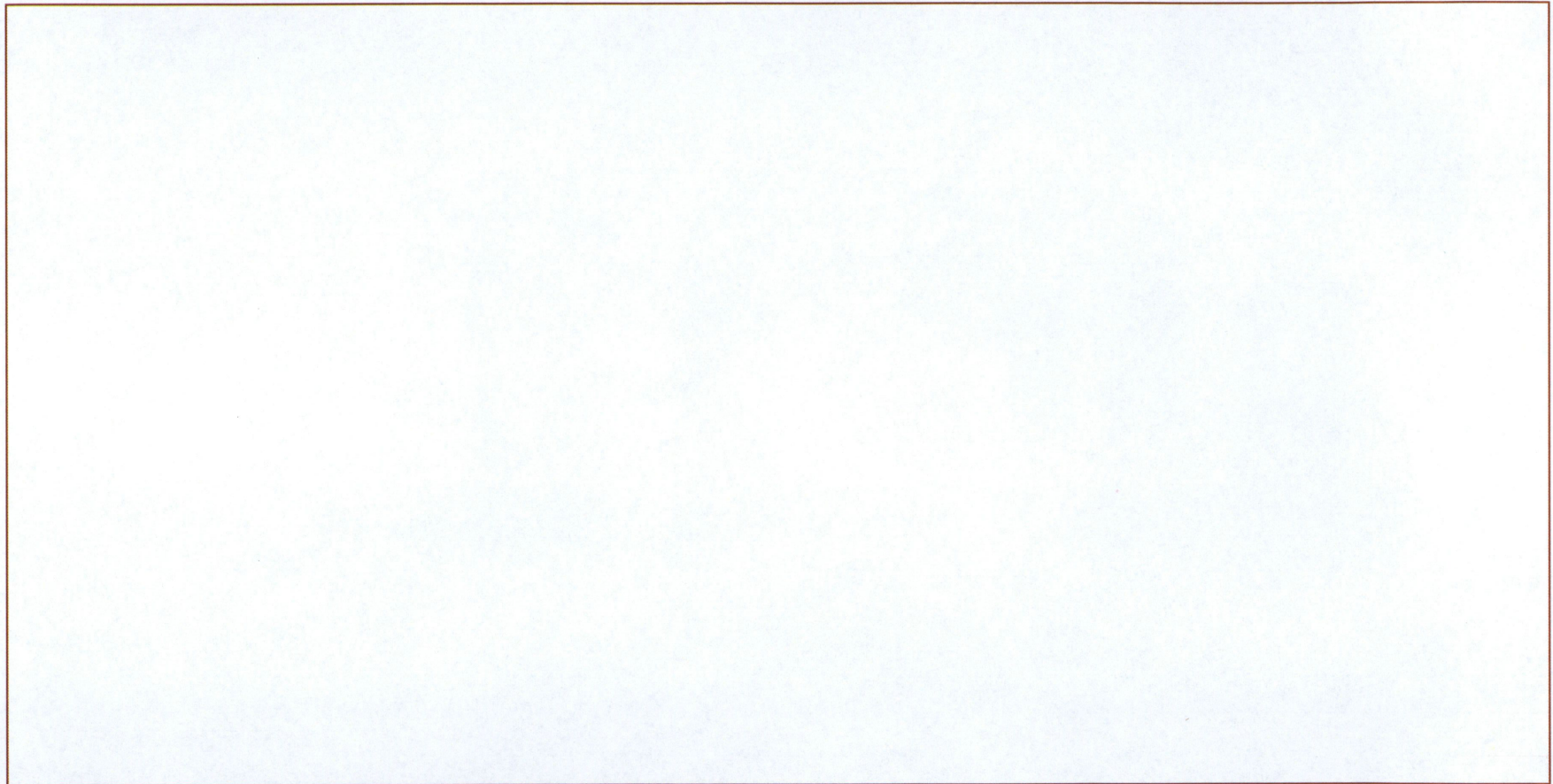

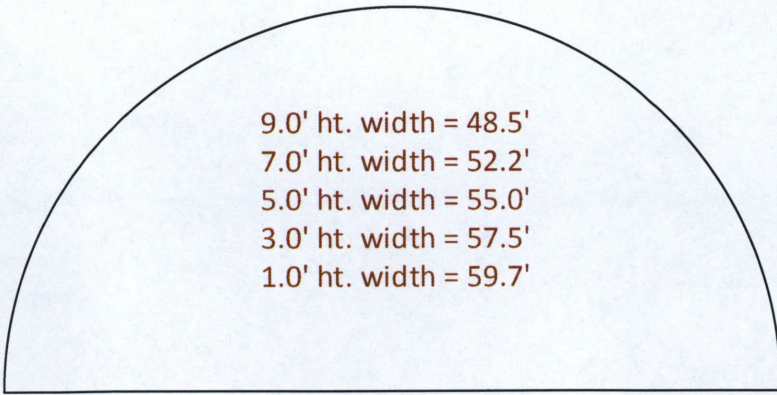

CENTRAL VALLEY BEAN  
CO-OP CORP# 257  
BUXTON ND  
Section F at Reynolds  
Twin quonsets:  
601 R North  
602 R South – NL eff. 1-31-19

Quonsets located on north  
edge of town east side of  
elevator road

Basics 60.0'W x 120.0'L  
Foundation 59.2'W x 114.2'L  
x 0.5' ht.  
Sidewall bolt seams top to  
floor = 1<sup>st</sup> 2.5' – 2<sup>nd</sup> 8.0'  
Horizontal sidewall brace  
10.3' to floor

Bottom center overhead u-  
trough 20.0' to floor  
Bottom overhead center  
drag 18.9' to floor  
Sidewall u-trough space 2.0'  
on center

Capacity calculated with 8.0'  
side depth + 17.0' center  
grain depth



CENTRAL VALLEY BEAN  
CO-OP CORP# 257  
BUXTON ND  
Section F at Reynolds  
Kuster West #604

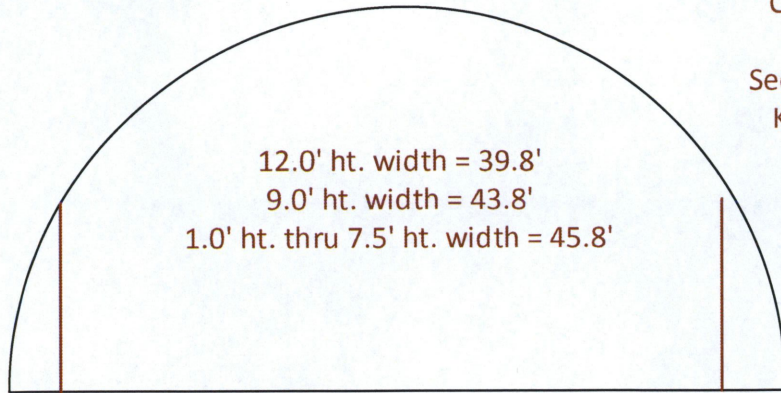

Location- 2<sup>nd</sup> potato  
warehouse site north of twin  
quonsets- west side of road

Capacity calculated with 7.5'  
sidewall depth + 14.5' center  
grain depth

Sidewalls are straight vertical  
walls ht. 7.5' West & 7.3' East  
Center ceiling to floor 17.75'  
Length of area with grain  
wall on both sides 71.5'



CENTRAL VALLEY BEAN  
CO-OP CORP# 257  
BUXTON ND  
Section F at Reynolds  
Kistler East #004

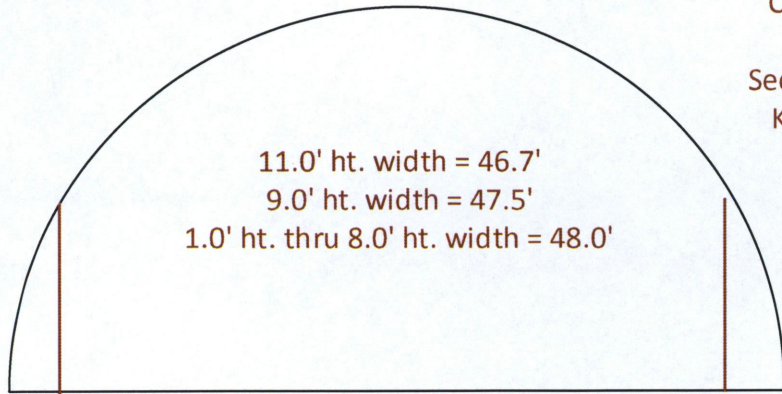

11.0' ht. width = 46.7'  
9.0' ht. width = 47.5'  
1.0' ht. thru 8.0' ht. width = 48.0'

Basics 48.0'W x 95.0'L  
Sidewalls are straight  
verticals walls 8.0' ht.

South bottom rafter to floor  
18.25'  
North bottom tin to floor  
18.0'

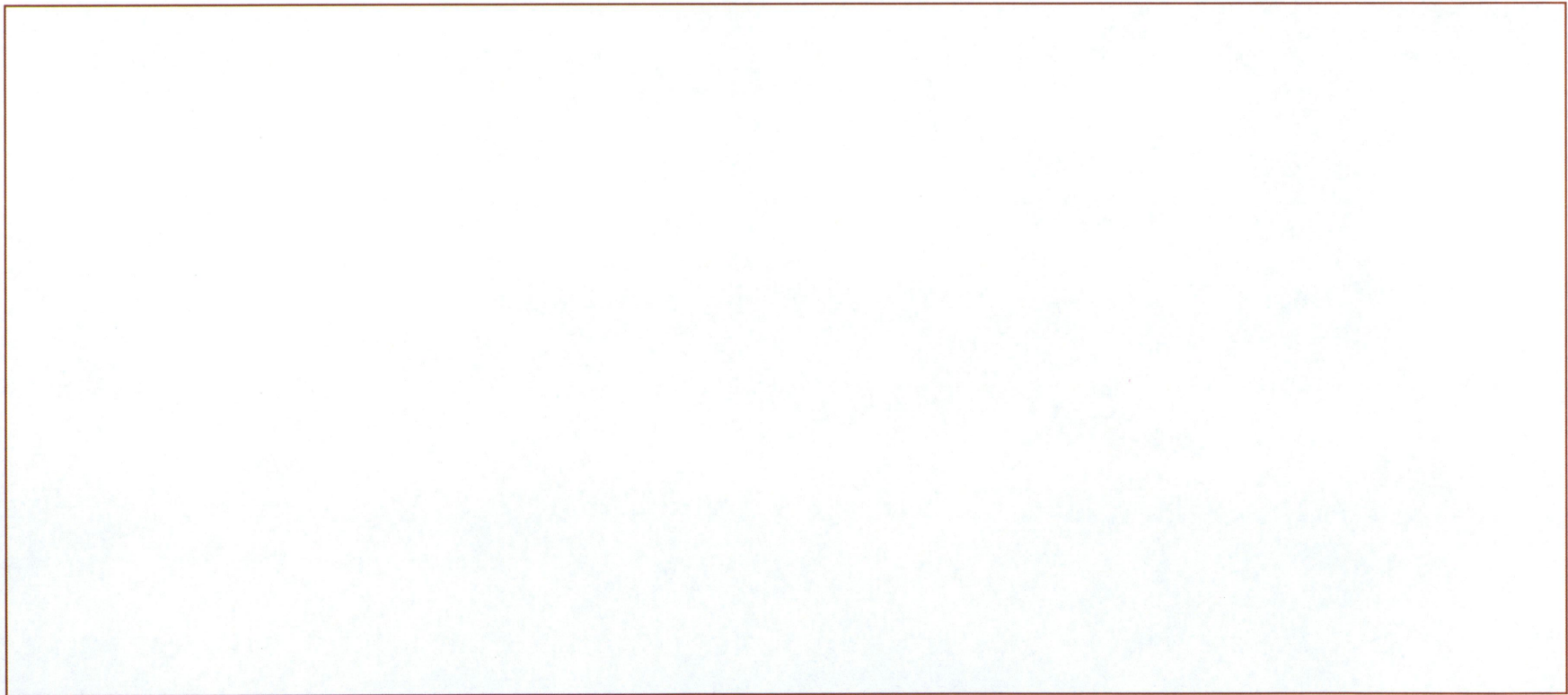

CENTRAL VALLEY BEAN  
CO-OP CORP# 257  
BUXTON ND  
Section F at Reynolds  
Galegher north  
609-1,2,3,4

Basics – all 4 flats  
33'W x 94.5'L x 8' straight  
sidewall ht.  
Center ceiling to floor 16'  
9' ht. width = 31.5'  
10' ht. width = 29.7'  
12' ht. width = 26.3'

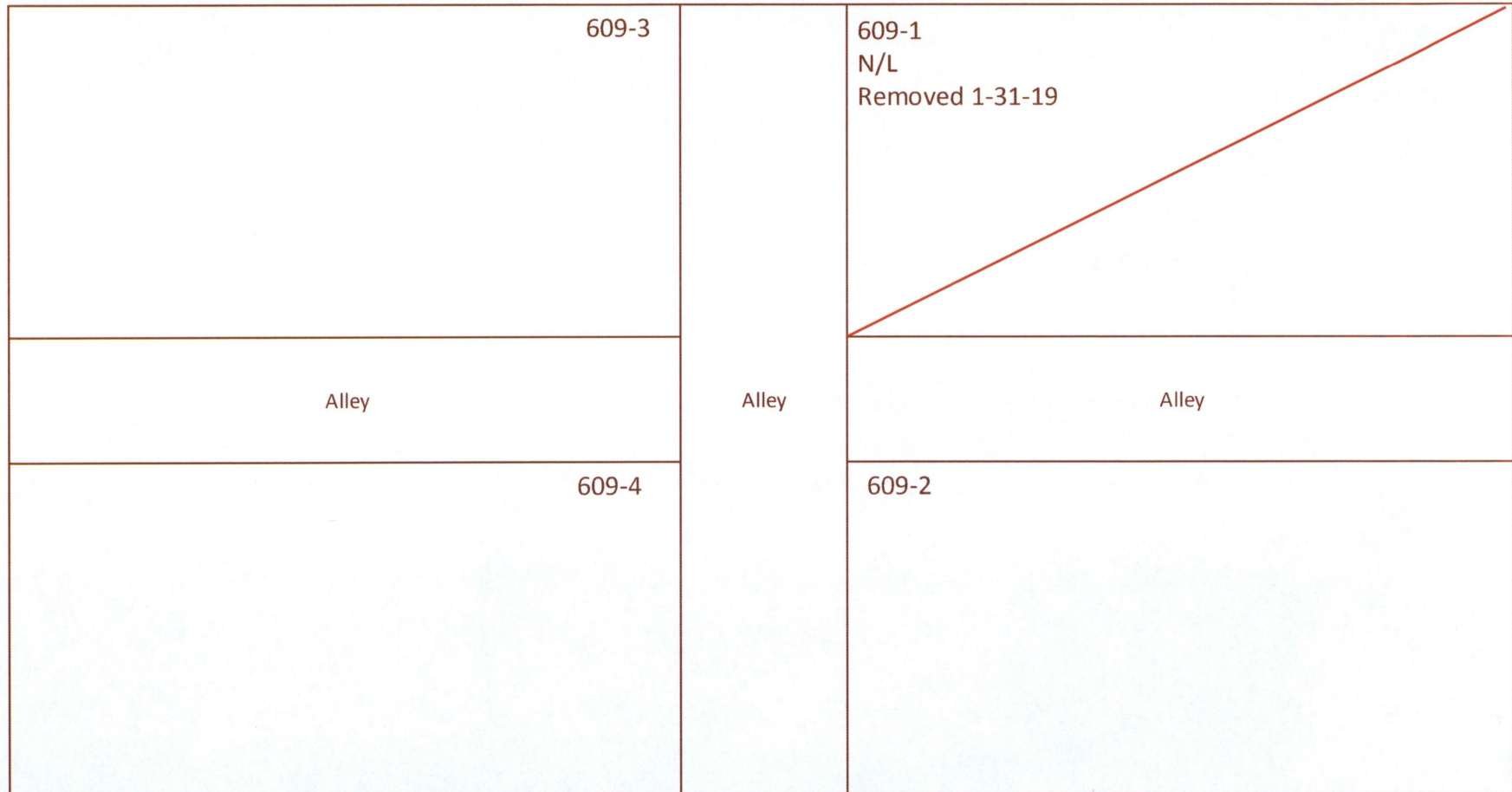

CENTRAL VALLEY BEAN  
CO-OP CORP# 257  
BUXTON ND  
Section F at Reynolds  
Galegher north  
610-1,2- 2 east flats

610-2 south flat  
92.5'L x 28'W x 12' straight  
vertical grain wall  
center ceiling ht. 16'

610-1 north  
84'L x 28'W x 12' straight  
vertical grain wall  
Center ceiling ht. 16'

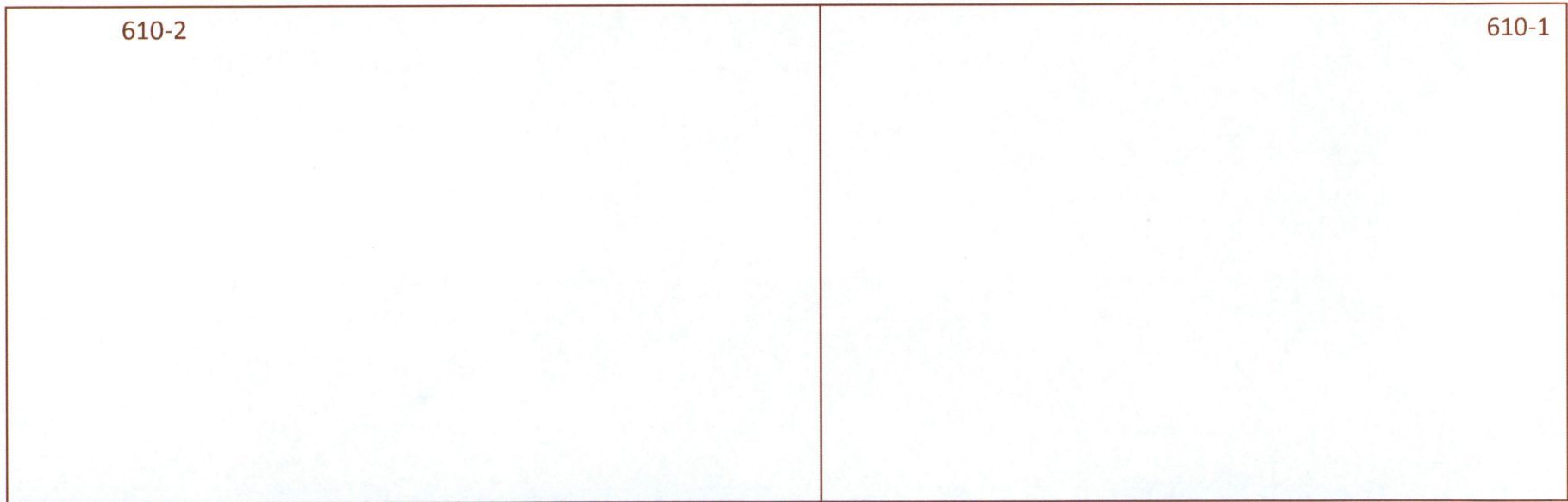

CENTRAL VALLEY BEAN  
CO-OP CORP# 257  
BUXTON ND  
Rural east of Reynolds  
Section J #802  
Lazur quonset

Location from beet site -  
1mile north- west side of  
road

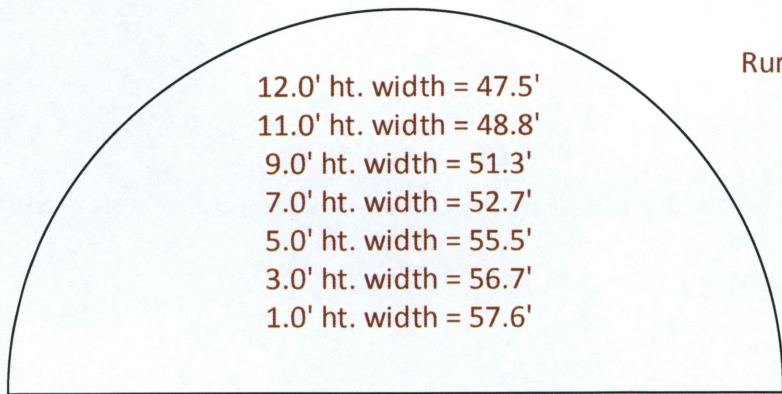

Capacity calculated with  
12.0' sidewall depth + 19.0'  
center grain depth

Basics 58.0'W x 148.0'L  
Bottom center u-trough 23.8'  
to floor

Red paint slash line east wall  
12.0' to floor  
Sidewall u-trough 1.0' on  
center

REMOVED 08/07/18  
PH  
NO LONGER LICENSED

CENTRAL VALLEY BEAN  
CO-OP CORP# 257  
BUXTON ND  
Rural east of Reynolds  
Section J #803  
Lazur east quonset  
Exterior foam insulation

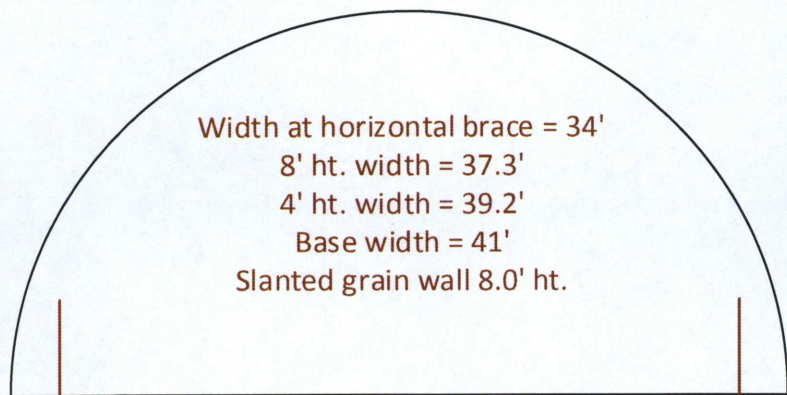

Width at horizontal brace = 34'  
8' ht. width = 37.3'  
4' ht. width = 39.2'  
Base width = 41'  
Slanted grain wall 8.0' ht.

Basics- 41'W x 141'L  
Center ceiling u-trough 17.5'  
ht.

Horizontal sidewall brace  
above grain wall 10.75' ht.  
U-trough space on center  
2.25'

REMOVED 08/07/18  
PH  
NO LONGER LICENSED

CENTRAL VALLEY BEAN

CO-OP CORP# 257

BUXTON ND

Rural east of Reynolds

Section J Moen potato

warehouse

Center ceiling ht. 18.5' high  
side

Located from beet site 2  
miles north west side of road

#5-6-7-8- 19'W x 115'L

#1-2-3-4 - 19'W x 79'L

005  REMOVED 08/07/18 PH NO LONGER LICENSED	Center Alley	001
006  REMOVED 08/07/18 PH NO LONGER LICENSED		002
007  REMOVED 08/07/18 PH NO LONGER LICENSED		003
008  REMOVED 08/07/18 PH NO LONGER LICENSED		004

CENTRAL VALLEY BEAN

CO-OP CORP# 257

BUXTON ND

Clem Moger twin quonsets

Section K:

903E – Removed Eff. 1-31-19

904W

Updated 4-8-19 AS

Located from Buxton .75  
mile west – 3 miles south-  
.25 mile west- north into  
yard

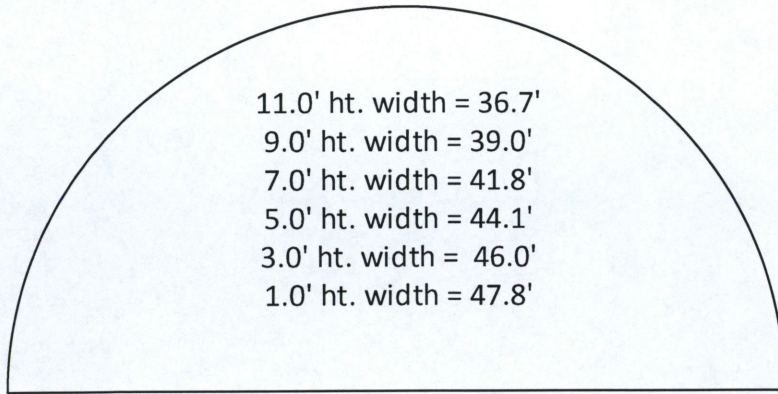

Basics 48.5'W x 118.7'L  
Top of first sidewall brace to  
floor = 11.2'

Bottom of overhead center  
u-trough to floor 17.5'  
Sidewall u-trough space on  
center 2.25'

Capacity calculated with 9.0'  
sidewall depth + 14.0' center  
grain depth

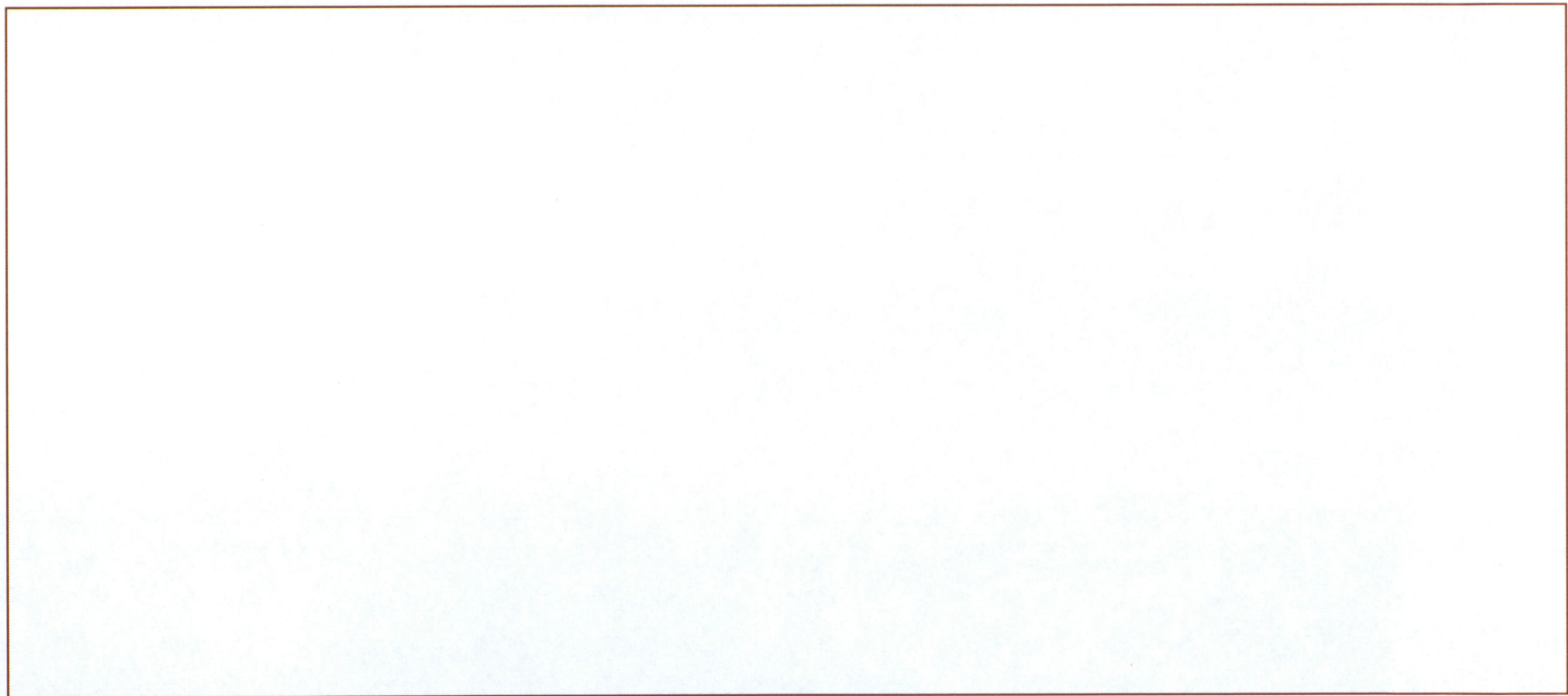

Central Valley Bean  
Hatton Receiving Station

North

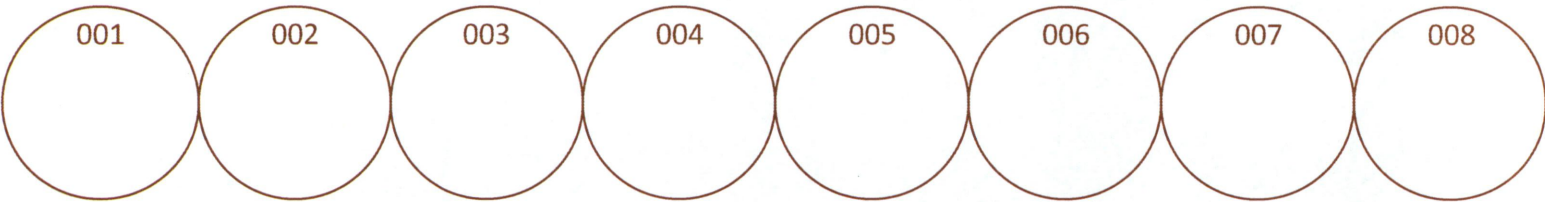
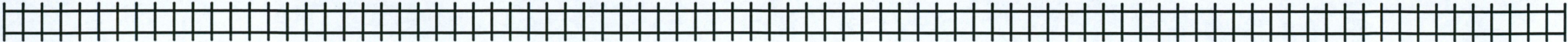
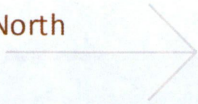

City Street

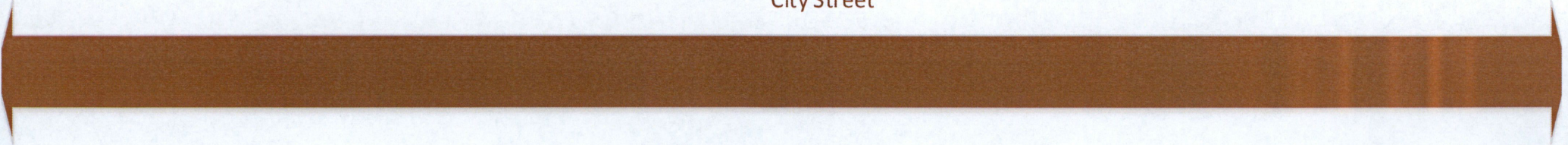

Central Valley Bean  
Grand Forks Storage  
Section GF

Exit 138 – 32 Ave S – 1 mile south  
East Building – west of RR tracks –  
southside of road

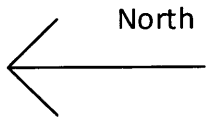

701

300' x 150' building split into  
2 bins. 74' wide, 300' long,  
peak height of 20', and 5' high  
on sidewalls

702

Central Valley Bean  
Pisek, ND  
Section P

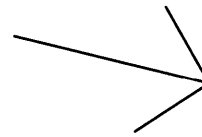
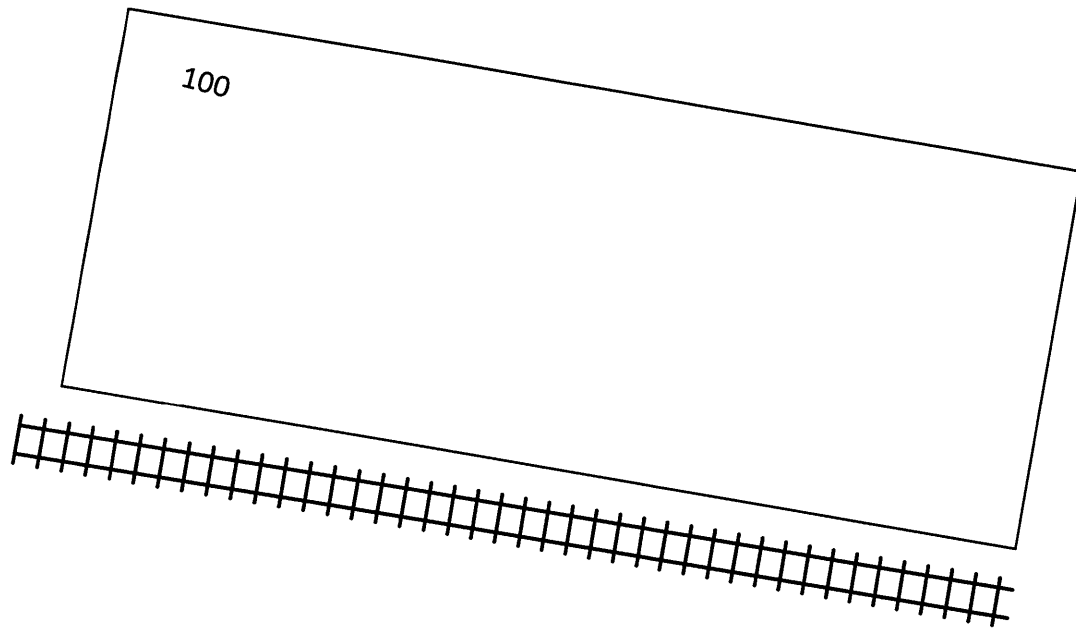

Wood Elevator  
And scale

Wood Elevator  
And Scale

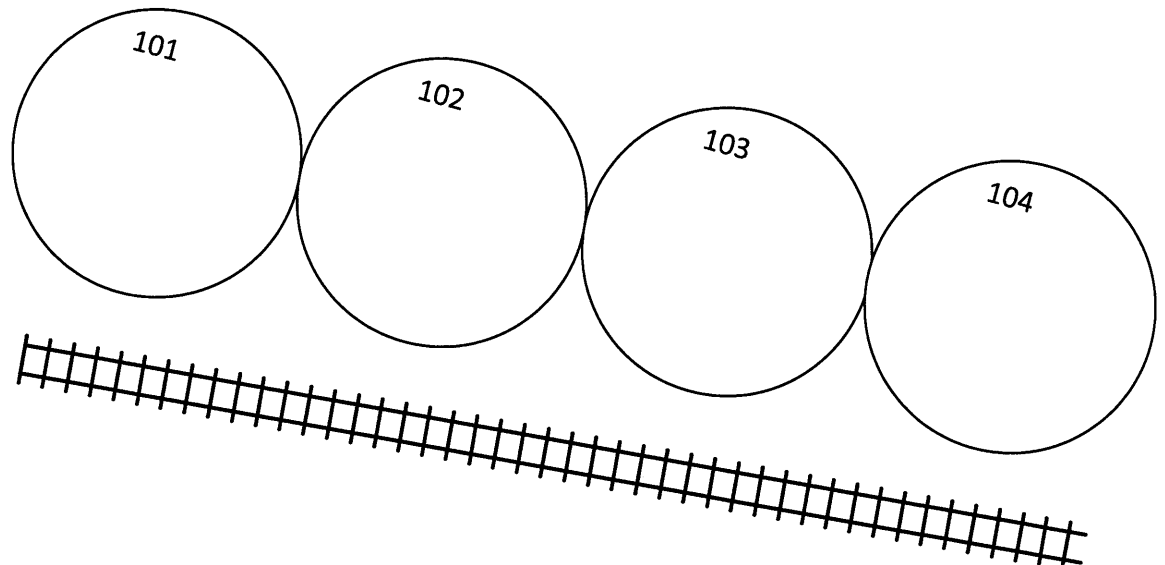
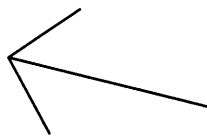

Central Valley Bean  
Devils Lake receiving station  
East of Devils Lake  
By CHS Grain Terminal

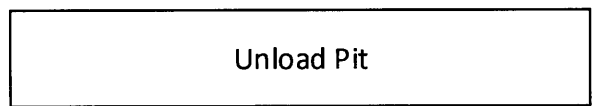
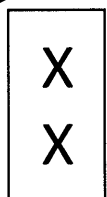
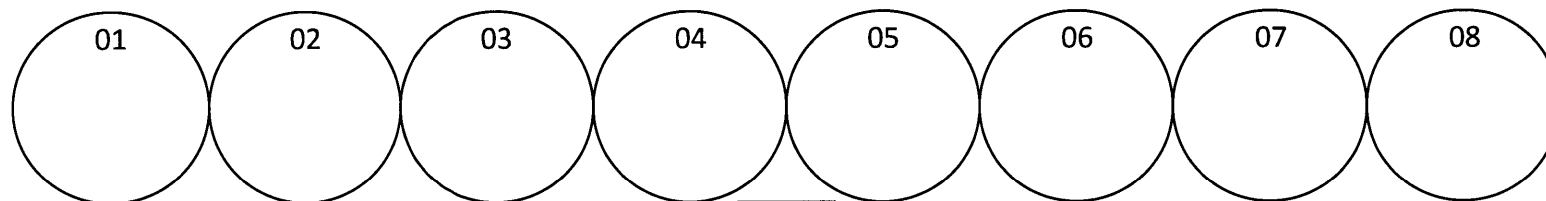

Central Valley Bean  
Larimore receiving station  
Colocated at AVBean  
08/07/18 PH

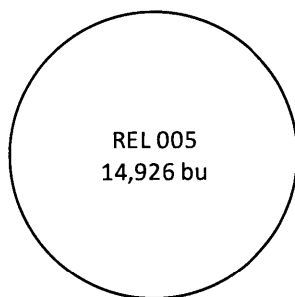

REL 005  
14,926 bu

Central Valley Bean  
Wilton Farmers Elevator  
0257  
PH 08/07/18



Central Valley Bean  
Receiving Station Barlow  
0257  
PH 08/07/18

REB 001  
3,933